

# IDEAONE 2023

fami

.04



INNOVATION  
SINCE 1929.



UTENSILERIE

CORAG





### CONSULENZA

Un particolare progetto che vorresti realizzare, una nuova area da allestire? I consulenti commerciali di Fami sono al tuo fianco per analizzare tutte le tue necessità e realizzare gli arredi ideali per la tua azienda.



### GARANZIA

I 10 anni di garanzia dei prodotti Fami sono la diretta espressione dell'utilizzo di materiali di qualità, della cura e dedizione nella produzione per rendere i nostri arredi affidabili e durevoli nel tempo.



### ORDINI

Ordinare i prodotti Fami Ideaone non è mai stato così facile! Scegli i diversi arredi e contatta il tuo agente di zona o rivenditore per completare il tuo ordine. Oppure visita Fami Shop per acquistare in pochi click!



### GAMMA COLORI

Gli arredi Fami Ideaone presentano colorazioni standard, sia monocolore che bicolore, che variano a seconda del prodotto scelto. Su richiesta sono disponibili ulteriori tonalità per personalizzare ogni area di lavoro o adattare gli arredi ai colori aziendali.



### VALIDITÀ

Il catalogo Fami Ideaone ha validità dal 27/04/2023 al 31/12/2023. I prezzi si ritengono validi durante tale periodo, salvo possibili variazioni, errori tipografici e/o omissioni di stampa.



### FILIALI E RIVENDITORI

Fami è sempre accanto a te! Negli anni abbiamo sviluppato quattro filiali europee oltre a un'ampia rete di rivenditori e distributori, sia in Italia che all'estero, per fornirti consulenza e assistenza ovunque tu sia.



### ASSISTENZA

Per qualsiasi domanda, informazione o problema il nostro servizio di assistenza post-vendita è sempre a tua disposizione. In caso di prodotti danneggiati o rotti riceverai sempre dei ricambi originali Fami in sostituzione.



### SPEDIZIONE

Gli arredi industriali Fami Ideaone sono disponibili con consegna entro 20 giorni lavorativi. La spedizione è gratuita per ordini superiori a 250,00 € (isole escluse), mentre per importi minori il costo di gestione ordine è pari a 30,00 €.



### VASCHE DI RACCOLTA + RIPIANI E VASCHE PERFORM IN ACCIAIO

Idonee a liquidi infiammabili delle categorie GHS 1 - 3 e liquidi inquinanti per le acque delle categorie GHS 1 - 4. Non sono ammesse sostanze corrosive.



### VASCHE DI RACCOLTA IN PE

Idonee a liquidi inquinanti per le acque delle categorie GHS 1 - 4. Non sono ammesse sostanze infiammabili.

**new**

MASTER



PIKPAD



THE BLOCK



BIN CART



ECOLOGIA





# indice

## BANCHI DA LAVORO

### 2

- **WORK MASTER BR** 2  
preconfigurati 3  
componenti 12  
materiale di separazione 20  
preconfigurati 22
- **WORK-WORK UP** 24  
preconfigurati 25  
componenti 34  
materiale di separazione 40  
preconfigurati 42
- **DYNAMIC** 44  
preconfigurati 45  
componenti 48



## PARETI ATTREZZATE

### 52

- **WORK LOOK** 52  
preconfigurati 53  
componenti 58  
tapparelle 64  
pensili 65
- **COMPONENTS** 66  
tavolo 67  
sedie 68
- **ERGO WORK** 70  
preconfigurati 71  
componenti 78  
preconfigurati 82
- **TOOL ORGANIZER** 84  
Unipok 85  
The Block 86  
Pikpad 88
- **IRON TEAM** 90  
Iron Team 91  
Iron Team Electric 96  
Iron Team Light 98



## ARMADI CON CASSETTI

### 100

#### SERIE START

- **FLEXA** 100  
36x27 EH 717x600 mm 102  
materiale di separazione 103  
54x27 EH 1023x600 mm 104  
materiale di separazione 105



#### SERIE PRO

- **MASTER DE** 106  
36x36 EH 714x726 mm 110  
materiale di separazione 111  
54x36 EH 1020x726 mm 112  
materiale di separazione 113  
54x36 EH 1020x726 mm 114  
accessori 115



#### SERIE PRO+

- **MASTER** 116  
18x27 EH 408x573 mm 122  
27x27 EH 561x573 mm 124  
36x27 EH 714x573 mm 128  
54x27 EH 1020x573 mm 136  
27x36 EH 561x726 mm 140  
36x36 EH 714x726 mm 148  
45x36 EH 867x726 mm 160  
54x36 EH 1020x726 mm 162  
64x36 EH 1190x726 mm 168  
78x36 EH 1428x726 mm 170  
accessori 172  
materiale di separazione:  
18x27 EH 408x573 mm 176  
27x27 EH 561x573 mm 178  
36x27 EH 714x573 mm 180  
54x27 EH 1020x573 mm 182  
27x36 EH 561x726 mm 184  
36x36 EH 714x726 mm 186  
45x36 EH 867x726 mm 188  
54x36 EH 1020x726 mm 190  
64x36 EH 1190x726 mm 192  
78x36 EH 1428x726 mm 193



## ARMADI PORTA COMPUTER

# 194

- MASTER CS 196
- STANDARD CS 198



## ARMADI CON PORTE

# 200

- PERFORM  
PORTE A BATTENTE 200
  - 64x27 EH 1193x555x1000 mm 201
  - 64x27 EH 1193x555x2000 mm 202
  - 24x27 EH 512x555x1000 mm 203
  - 54x27 EH 1023x555x1000 mm 204
  - 54x27 EH 1023x555x2000 mm 206
  - componenti 214
  - materiale di separazione 226
- PERFORM  
PORTE SCORREVOLI 228
  - 54x27 EH 1020x600x2000 mm 230
  - 54x27 EH 1020x600x946 mm 231
  - 78x27 EH 1428x600x2000 mm 232
  - 54+54x27 EH 2040x600x2000 mm 234
  - 54+54x27 EH 2040x600x946 mm 236
  - componenti 237
  - materiale di separazione 245
- PERFORM  
SPOGLIATOIO 246



## NC

# 252

- NC 253
- componenti 254



## ECOLOGIA

# 256

- PORTA BIG BAG 257
- BENNE 258
- VASCHE DI RACCOLTA 260
- ARMADI DI SICUREZZA 267



## CARRELLI

# 270

- CLEVER 270
  - Clever Small preconfigurati 271
  - Clever Large preconfigurati 272
  - componenti 277
- COMBI 281
- BIN CART 282
  - preconfigurati 283
  - componenti 296



## SCAFFALI

# 302

- SYSTEM ST 302
- STORAGE DOMINO 304



## CASSETTE E CONTENITORI IN METALLO

# 308

- CASSETTE E CONTENITORI 309
- CONTENITORI FONDO APRIBILE 312
- CONTENITORI BOCCA DI LUPO 313



## CASSETTE E CONTENITORI IN PLASTICA

# 314

- EURO BOX 315
- NESTABLE BOX LIGHT 319
- PICKING BOX 319
- VISUAL BOX 322
- MAT 323



## ARREDO OFFICINA

# 324

## GEAR GARAGE

- preconfigurati 333
- MODULI 345
  - corner 345
  - L= 714 mm 346
  - L= 1020 mm 348
  - L= 1428 mm 350
  - L= 1734 mm 353
  - L= 2040 mm 356
- PERFOM PORTE BATTENTI 361
  - L= 512 mm 361
  - L= 1023 mm 362
- PERFOM PORTE SCORREVOLI 364
  - L= 1020 mm 364
  - L= 1427 mm 365
  - L= 2040 mm 366
- accessori 369
- materiale di separazione 370



- CONDIZIONI GENERALI DI GARANZIA 377
- CONDIZIONI GENERALI DI VENDITA 378

# WORK MASTER BR

## BANCHI DA LAVORO

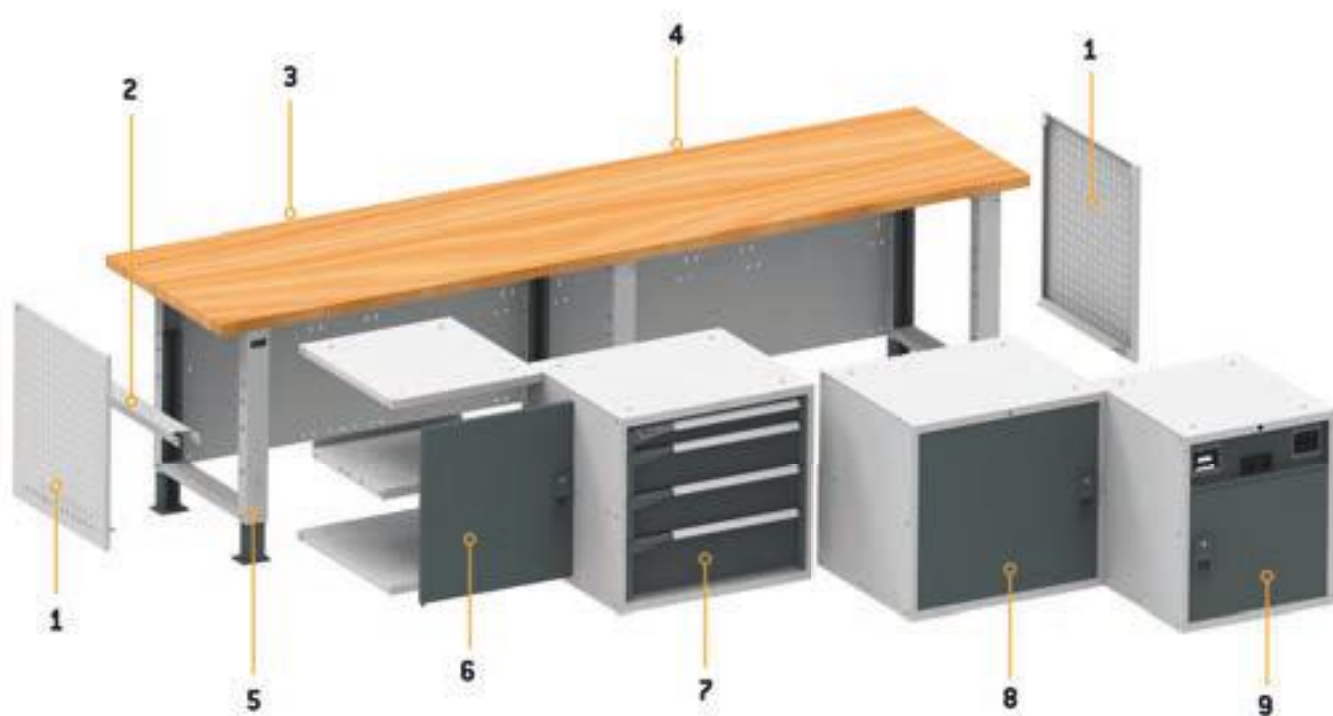

1. Pannello forato laterale
2. Supporto semipiano intermedio
3. Chiusura posteriore
4. Piano in Multiplex
5. Gambe regolabili

6. Modulo componibile
7. Armadio a cassetti
8. Armadio con porta
9. Armadio tecnico con porta

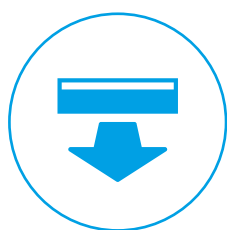

**Cassetti ad estrazione totale**

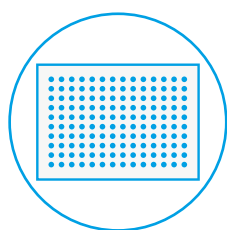

**Fondo cassetto forato**

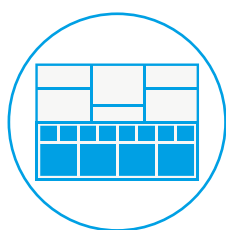

**Materiale di separazione**



**Chiusura a chiave**

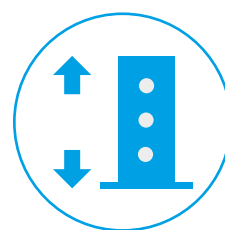

**Gambe regolabili in altezza**

# WORK MASTER BR



ART.	Lmm	Pmm	Hmm		RAL	€
<b>MASTERBR2007</b>	2206	750	1805/2180	1000	7035+7016	2745,00

Composto da:





qtà	descrizione	qtà	descrizione
1	Banco smontato con piano in multiplex 40 mm	2	Pensile vasistas senza serratura
1	Armadio L=560 mm con 4 cassetti 1x75 2x150 1x200	2	Coppia staffe di fissaggio pensile su montanti
4	Piano superiore/inferiore L=560 mm	2	Barra led
1	Porta totale destra H=600 mm con maniglia Dark Grey	2	Multipresa schuko a 2 scomparti
1	Porta totale sinistra H=600 mm con maniglia Dark Grey	1	Multipresa schuko a 4 scomparti
2	Supporto semipiano intermedio	1	Magnetotermico differenziale
2	Piano interno L=558 mm	1	Cavo di collegamento wieland schuko/francese
2	Pannello forato laterale	1	Tasca porta documenti A4
1	Pannello forato/mensola con 1 bordo fermacasse	1	Kit porta rotolo con carta Ø=240 mm
1	Kit 3 montanti biasolati	2	Porta bombolette inclinato a 2 posti
1	Kit 2 pannelli forati/mensole con 1 bordo fermacasse	5	Gancio Unipok per utensili - confezione 30 pezzi
1	Pannello forato electric	1	Cestino capacità 30 L



RAL 7035 + RAL 7016



PORTATA

 **1000 kg**     
  **regolabili in altezza**     
  **piano in multiplex spessore 40 mm**  
 **Forniti smontati**     
  **passo fori gambe 25 mm**



ART.	L mm	P mm	H mm	RAL	€
<b>MASTERBR1505</b>	1500	750	740/1115	7035+7016	772,80

Composto da:

qtà	descrizione
1	Banco smontato con piano in multiplex 40 mm
1	Armadio L=560 mm con 3 cassetti 1x75 2x100
1	Coppia squadre di rinforzo



ART.	L mm	P mm	H mm	RAL	€
<b>MASTERBR1506</b>	1500	750	740/1115	7035+7016	847,80

Composto da:

qtà	descrizione
1	Banco smontato con piano in multiplex 40 mm
1	Armadio L=560 mm con 4 cassetti 1x75 2x150 1x200
1	Coppia squadre di rinforzo



ART.	L mm	P mm	H mm	RAL	€
<b>MASTERBR1501</b>	1500	750	740/1115	7035+7016	984,60

Composto da:

qtà	descrizione
1	Banco smontato con piano in multiplex 40 mm
1	Armadio L=560 mm con 4 cassetti 1x75 2x150 1x200
2	Semipiano aggiuntivo L=560 mm
1	Supporto semipiano intermedio
2	Pannello forato laterale



# WORK MASTER BR

# 1500

## Esempi di configurazione



Utensili esclusi



Utensili esclusi



Utensili esclusi



ART.	L mm	P mm	H mm	RAL	€
<b>MASTERBR1514</b>	1500	750	1683/2058	7035+7016	1082,40

Composto da:

qtà	descrizione
1	Banco smontato con piano in multiplex 40 mm
1	Armadio L=560 mm con 3 cassetti 1x75 2x100
1	Coppia squadre di rinforzo
1	Kit 2 montanti biasolati
1	Kit 3 pannelli forati/mensole con 2 bordi fermacasse
6	Gancio Unipok per utensili - confezione 30 pezzi
2	Barra aggancio con 4 contenitori Picking Box misura 1

ART.	L mm	P mm	H mm	RAL	€
<b>MASTERBR1515</b>	1500	750	1683/2058	7035+7016	1157,40

Composto da:

qtà	descrizione
1	Banco smontato con piano in multiplex 40 mm
1	Armadio L=560 mm con 4 cassetti 1x75 2x150 1x200
1	Coppia squadre di rinforzo
1	Kit 2 montanti biasolati
1	Kit 3 pannelli forati/mensole con 2 bordi fermacasse
6	Gancio Unipok per utensili - confezione 30 pezzi
2	Barra aggancio con 4 contenitori Picking Box misura 1

ART.	L mm	P mm	H mm	RAL	€
<b>MASTERBR1510</b>	1500	750	1683/2058	7035+7016	1294,20

Composto da:





qtà	descrizione
1	Banco smontato con piano in multiplex 40 mm
2	Pannello forato laterale
1	Armadio L=560 mm con 4 cassetti 1x75 2x150 1x200
2	Semipiano aggiuntivo L=560 mm
1	Supporto semipiano intermedio
1	Kit 2 montanti biasolati
1	Kit 3 pannelli forati/mensole con 2 bordi fermacasse
6	Gancio Unipok per utensili - confezione 30 pezzi
2	Barra aggancio con 4 contenitori Picking Box misura 1



RAL 7035 + RAL 7016

PORTATA



-  **1000 kg**
-  **regolabili in altezza**
-  **piano in multiplex spessore 40 mm**
-  **Forniti smontati**
-  **passo fori gambe 25 mm**



ART.	L mm	P mm	H mm	RAL	€
<b>MASTERBR1502</b>	1500	750	740/1115	7035+7016	1071,30

Composto da:

qtà	descrizione
1	Banco smontato con piano in multiplex 40 mm
1	Armadio L=560 mm con 4 cassetti 1x75 2x150 1x200
2	Piano superiore/inferiore L=560 mm
1	Porta totale sinistra H=600 mm con maniglia Dark Grey
1	Supporto semipiano intermedio
1	Piano interno L=558 mm
2	Pannello forato laterale



ART.	L mm	P mm	H mm	RAL	€
<b>MASTERBR1503</b>	1500	750	740/1115	7035+7016	1437,00

Composto da:

qtà	descrizione
1	Banco smontato con piano in multiplex 40 mm
1	Armadio L=560 mm con 4 cassetti 1x75 2x150 1x200
1	Armadio L=560 mm con 5 cassetti 1x75 3x100 1x200



ART.	L mm	P mm	H mm	RAL	€
<b>MASTERBR1504</b>	1500	750	740/1115	7035+7016	995,40

Composto da:

qtà	descrizione
1	Banco smontato con piano in multiplex 40 mm
2	Armadio L=560 mm predisposto per porta con 1 cassetto H=150 mm
1	Porta parziale sinistra H=435 mm con maniglia Dark Grey
1	Porta parziale destra H=435 mm con maniglia Dark Grey





# WORK MASTER BR

# 1500

## Esempi di configurazione



Utensili esclusi



Utensili esclusi



Utensili esclusi



ART.	L mm	P mm	H mm	RAL	€
<b>MASTERBR1511</b>	1500	750	1683/2058	7035+7016	1380,90

Composto da:

qtà	descrizione
1	Banco smontato con piano in multiplex 40 mm
2	Pannello forato laterale
1	Armadio L=560 mm con 4 cassetti 1x75 2x150 1x200
2	Piano superiore/inferiore L=560 mm
1	Porta totale sinistra H=600 mm con maniglia Dark Grey
1	Piano interno L=558 mm
1	Supporto semipiano intermedio
1	Kit 2 montanti biasolati
1	Kit 3 pannelli forati/mensole con 2 bordi fermacasse
6	Gancio Unipok per utensili - confezione 30 pezzi
2	Barra aggancio con 4 contenitori Picking Box misura 1

ART.	L mm	P mm	H mm	RAL	€
<b>MASTERBR1512</b>	1500	750	1683/2058	7035+7016	1746,60

Composto da:

qtà	descrizione
1	Banco smontato con piano in multiplex 40 mm
1	Armadio L=560 mm con 4 cassetti 1x75 2x150 1x200
1	Armadio L=560 mm con 5 cassetti 1x75 3x100 1x200
1	Kit 2 montanti biasolati
1	Kit 3 pannelli forati/mensole con 2 bordi fermacasse
6	Gancio Unipok per utensili - confezione 30 pezzi
2	Barra aggancio con 4 contenitori Picking Box misura 1

ART.	L mm	P mm	H mm	RAL	€
<b>MASTERBR1513</b>	1500	750	1683/2058	7035+7016	1305,00





Composto da:

qtà	descrizione
1	Banco smontato con piano in multiplex 40 mm
2	Armadio L=560 mm predisposto per porta con 1 cassetto H=150 mm
1	Porta parziale sinistra H=435 mm con maniglia Dark Grey
1	Porta parziale destra H=435 mm con maniglia Dark Grey
1	Kit 2 montanti biasolati
1	Kit 3 pannelli forati/mensole con 2 bordi fermacasse
6	Gancio Unipok per utensili - confezione 30 pezzi
2	Barra aggancio con 4 contenitori Picking Box misura 1



RAL 7035 + RAL 7016

PORTATA

-  **1000 kg**
-  **regolabili in altezza**
-  **piano in multiplex spessore 40 mm**
-  **Forniti smontati**
-  **passo fori gambe 25 mm**

ART.	L mm	P mm	H mm	RAL	€
<b>MASTERBR2005</b>	2000	750	740/1115	7035+7016	825,90

Composto da:

qtà	descrizione
1	Banco smontato con piano in multiplex 40 mm
1	Armadio L=560 mm con 3 cassetti 1x75 2x100
1	Coppia squadre di rinforzo



ART.	L mm	P mm	H mm	RAL	€
<b>MASTERBR2006</b>	2000	750	740/1115	7035+7016	900,90

Composto da:

qtà	descrizione
1	Banco smontato con piano in multiplex 40 mm
1	Armadio L=560 mm con 4 cassetti 1x75 2x150 1x200
1	Coppia squadre di rinforzo



ART.	L mm	P mm	H mm	RAL	€
<b>MASTERBR2001</b>	2000	750	740/1115	7035+7016	1200,00

Composto da:

qtà	descrizione
1	Banco smontato con piano in multiplex 40 mm
1	Armadio L=560 mm con 4 cassetti 1x75 2x150 1x200
1	Armadio L=560 mm predisposto per porta con 1 piano regolabile
1	Porta totale sinistra H=600 mm con maniglia Dark Grey
2	Semipiano aggiuntivo L=560 mm



## Esempi di configurazione

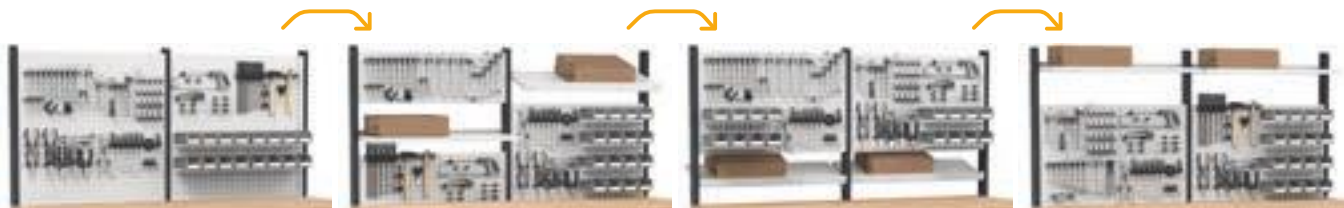

Utensili esclusi



Utensili esclusi



Utensili esclusi



ART.	L mm	P mm	H mm	RAL	€
<b>MASTERBR2013</b>	2000	750	1683/2058	7035+7016	1258,50

Composto da:

qtà	descrizione
1	Banco smontato con piano in multiplex 40 mm
1	Armadio L=560 mm con 3 cassetti 1x75 2x100
1	Coppia squadre di rinforzo
1	Kit 3 montanti biasolati
2	Kit 3 pannelli forati/mensole con 2 bordi fermacasse
6	Gancio Unipok per utensili - confezione 30 pezzi
4	Barra aggancio con 4 contenitori Picking Box misura 1

ART.	L mm	P mm	H mm	RAL	€
<b>MASTERBR2014</b>	2000	750	1683/2058	7035+7016	1333,50

Composto da:





qtà	descrizione
1	Banco smontato con piano in multiplex 40 mm
1	Armadio L=560 mm con 4 cassetti 1x75 2x150 1x200
1	Coppia squadre di rinforzo
1	Kit 3 montanti biasolati
2	Kit 3 pannelli forati/mensole con 2 bordi fermacasse
6	Gancio Unipok per utensili - confezione 30 pezzi
4	Barra aggancio con 4 contenitori Picking Box misura 1

ART.	L mm	P mm	H mm	RAL	€
<b>MASTERBR2009</b>	2000	750	1683/2058	7035+7016	1632,60

Composto da:

qtà	descrizione
1	Banco smontato con piano in multiplex 40 mm
1	Armadio L=560 mm predisposto per porta con 1 piano regolabile
1	Porta totale sinistra H=600 mm con maniglia Dark Grey
1	Armadio L=560 mm con 4 cassetti 1x75 2x150 1x200
2	Semipiano aggiuntivo L=560 mm
1	Kit 3 montanti biasolati
2	Kit 3 pannelli forati/mensole con 2 bordi fermacasse
6	Gancio Unipok per utensili - confezione 30 pezzi
4	Barra aggancio con 4 contenitori Picking Box misura 1



-  **1000 kg**
-  **regolabili in altezza**
-  **piano in multiplex spessore 40 mm**
-  **Forniti smontati**
-  **passo fori gambe 25 mm**



ART.	L mm	P mm	H mm	RAL	€
MASTERBR2002	2000	750	740/1115	7035+7016	1547,10

Composto da:

qtà	descrizione
1	Banco smontato con piano in multiplex 40 mm
1	Armadio L=560 mm con 4 cassetti 1x75 2x150 1x200
1	Armadio L=560 mm con 5 cassetti 1x75 3x100 1x200
2	Semipiano aggiuntivo L=560 mm



ART.	L mm	P mm	H mm	RAL	€
MASTERBR2003	2000	750	740/1115	7035+7016	1357,80

Composto da:

qtà	descrizione
1	Banco smontato con piano in multiplex 40 mm
1	Armadio L=560 mm con 5 cassetti 1x75 3x100 1x200
4	Piano superiore/inferiore L=560 mm
1	Porta totale destra H=600 mm con maniglia Dark Grey
1	Porta totale sinistra H=600 mm con maniglia Dark Grey
2	Supporto semipiano intermedio
2	Piano interno L=558 mm
2	Pannello forato laterale



ART.	L mm	P mm	H mm	RAL	€
MASTERBR2004	2000	750	740/1115	7035+7016	1393,20

Composto da:

qtà	descrizione
1	Banco smontato con piano in multiplex 40 mm
3	Armadio L=560 mm predisposto per porta con 1 cassetto H=150 mm
1	Porta parziale destra H=435 mm con maniglia Dark Grey
2	Porta parziale sinistra H=435 mm con maniglia Dark Grey



## Esempi di configurazione

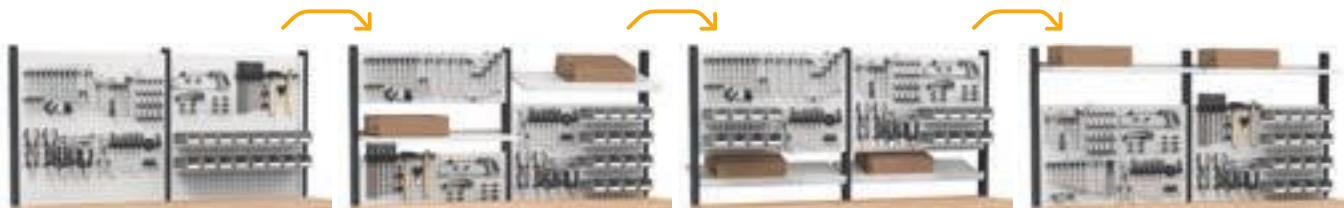

Utensili esclusi



Utensili esclusi



Utensili esclusi



ART.	L mm	P mm	H mm	RAL	€
<b>MASTERBR2010</b>	2000	750	1683/2058	7035+7016	1979,70

Composto da:

qtà	descrizione
1	Banco smontato con piano in multiplex 40 mm
1	Armadio L=560 mm con 5 cassetti 1x75 3x100 1x200
1	Armadio L=560 mm con 4 cassetti 1x75 2x150 1x200
2	Semipiano aggiuntivo L=560 mm
1	Kit 3 montanti biasolati
2	Kit 3 pannelli forati/mensole con 2 bordi fermacasse
6	Gancio Unipok per utensili - confezione 30 pezzi
4	Barra aggancio con 4 contenitori Picking Box misura 1

ART.	L mm	P mm	H mm	RAL	€
<b>MASTERBR2011</b>	2000	750	1683/2058	7035+7016	1790,40

Composto da:

qtà	descrizione
1	Banco smontato con piano in multiplex 40 mm
4	Piano superiore/inferiore L=560 mm
1	Porta totale sinistra H=600 mm con maniglia Dark Grey
1	Porta totale destra H=600 mm con maniglia Dark Grey
2	Piano interno L=558 mm
2	Supporto semipiano intermedio
1	Armadio L=560 mm con 5 cassetti 1x75 3x100 1x200
2	Pannello forato laterale
1	Kit 3 montanti biasolati
2	Kit 3 pannelli forati/mensole con 2 bordi fermacasse
6	Gancio Unipok per utensili - confezione 30 pezzi
4	Barra aggancio con 4 contenitori Picking Box misura 1

ART.	L mm	P mm	H mm	RAL	€
<b>MASTERBR2012</b>	2000	750	1683/2058	7035+7016	1825,80

Composto da:





qtà	descrizione
1	Banco smontato con piano in multiplex 40 mm
3	Armadio L=560 mm predisposto per porta con 1 cassetto H=150 mm
2	Porta parziale sinistra H=435 mm con maniglia Dark Grey
1	Porta parziale destra H=435 mm con maniglia Dark Grey
1	Kit 3 montanti biasolati
2	Kit 3 pannelli forati/mensole con 2 bordi fermacasse
6	Gancio Unipok per utensili - confezione 30 pezzi
4	Barra aggancio con 4 contenitori Picking Box misura 1



RAL 7035 + RAL 7016



PORTATA

-  **1000 kg**
-  **regolabili in altezza**
-  **piano in multiplex spessore 40 mm**
-  **Forniti smontati**
-  **passo fori gambe 25 mm**



ART.	Lmm	Pmm	Hmm	piano		RAL	€
				materiale	mm		
MBR01S0V0V001PD	1024	750	740/1115	Multiplex	40	7035+7016	262,80



ART.	Lmm	Pmm	Hmm	piano		RAL	€
				materiale	mm		
MBR02S0V0V001PD	1500	750	740/1115	Multiplex	40	7035+7016	306,00



ART.	Lmm	Pmm	Hmm	piano		RAL	€
				materiale	mm		
MBR03S0V0V001PD	2000	750	740/1115	Multiplex	40	7035+7016	359,10



ART.	Lmm	Pmm	Hmm	piano		RAL	€
				materiale	mm		
MBR04S0V0V001PD	3000	750	740/1115	Multiplex	40	7035+7016	631,80



### Imballo banco smontato



### Coppia squadre di rinforzo

ART.	Lmm	Pmm	Hmm	RAL	€
FBGKITS0008	145	39	145	7035	16,50

 Utilizzare una squadra per gamba se non è presente la cassettera o il piano (una coppia per banchi 1024/1500/2000, due coppie per banchi 3000)





### Copertura per piano in multiplex

ART.	L mm	P mm	H mm	adatto per	colore	€
FBL22300007	1028	754	22	Piano in multiplex	Nero	80,40
FBL22600007	1504	754	22	Piano in multiplex	Nero	111,30
FBL22900007	2004	754	22	Piano in multiplex	Nero	142,20
FBL23200007	3004	754	22	Piano in multiplex	Nero	266,10

### Schema Tecnico

L → 1000 mm



L → 1500 mm



L → 2000 mm

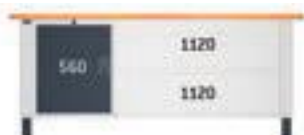
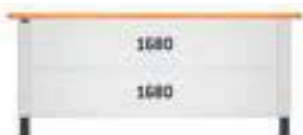

L → 3000 mm



RAL 7035 + RAL 7016



RAL 7035



PORTATA



SPESSORE

Armadi con cassetti

L  560 mm

27x27 EH

### Armadio con 3 cassetti





ART.	L mm	P mm	H mm	cassetti					RAL	€
				n.	h 75 mm	h 100 mm				
MBR05SC010203PD	560	610	369	3	1	2	100-75-50	92-96-100%	7035+7016	450,30



### Armadio con 4 cassetti





ART.	L mm	P mm	H mm	cassetti					RAL	€	
				n.	h 75 mm	h 150 mm	h 200 mm				
MBR05SC010204PD	560	610	669	4	1	2	1	100-75-50	92-96-100%	7035+7016	525,30



### Armadio con 5 cassetti



ART.	L mm	P mm	H mm	cassetti					RAL	€	
				n.	h 75 mm	h 100 mm	h 200 mm				
MBR05SC010205PD	560	610	669	5	1	3	1	100-75-50	92-96-100%	7035+7016	605,70



### Armadio con piano intermedio predisposto per porte

ART.	L mm	P mm	H mm	piano regolabile	RAL	€
MBR05SX00020708	560	610	669	1	7035	204,60



### Porta totale sinistra H=600 mm con maniglia Dark Grey

ART.	L mm	P mm	H mm	apertura	RAL	€
MBR06SC01020239	504	34	600	Sinistra	7016	54,00



### Porta totale destra H=600 mm con maniglia Dark Grey

ART.	L mm	P mm	H mm	apertura	RAL	€
MBR06SC01020139	504	34	600	Destra	7016	54,00



Armadi con cassettei

L  560 mm

27x27 EH



### Armadio tecnico L=560 mm predisposto per porta

Adatto per porte Art. MBR06SC01020339 e Art. MBR06SC01020439

ART.	L mm	P mm	H mm	RAL	€
MBR05SX000208PD	560	610	669	7035+7016	226,80



### Arrotolatore elettrico con presa Schuko

ART.	L cavo m	tipo presa	Volt	Watt	€
MBR13S0V0V00100	20	Schuko	230	1600	517,50



### Arrotolatore per aria compressa

ART.	L cavo m	Pressione max Mpa	Ø mm	€
MBR13S0V0V00200	14	1,5	10	237,60



### Rullo per arrotolatore

ART.	€
MBR13S0V0V00339	28,20



### Piastra per arrotolatore

Da fissare alla parte posteriore dell'armadio

ART.	€
MBR13S0V0V00499	20,10



1. Armadio tecnico L=560 mm predisposto per porta
2. Modulo: Rullo per arrotolatore



3. Modulo: Multipresa a 4 scomparti
4. Modulo: Multipresa a 2 scomparti



RAL 7035 + RAL 7016



RAL 7016



RAL 7035



ESTRAZIONE



PORTATA



## Armadi con cassetti

L  560 mm

27x27 EH

Armadio L=560 mm predisposto per porta con 1 cassetto H=150 mm



ART.	L mm	P mm	H mm	cassetti			RAL	€
				h 150 mm				
MBR05SC010206PD	560	610	669	1	100-75-50	92-96-100%	7035+7016	293,70



Porta parziale sinistra H=435 mm con maniglia Dark Grey



ART.	L mm	P mm	H mm	apertura	RAL	€
MBR06SC01020439	504	34	435	Sinistra	7016	51,00

Porta parziale destra H=435 mm con maniglia Dark Grey



ART.	L mm	P mm	H mm	apertura	RAL	€
MBR06SC01020339	504	34	435	Destra	7016	51,00



## Armadi con cassetti

L  713 mm

36x27 EH

Armadio L=713 mm con 4 cassetti 1x75 2x150 1x200





ART.	L mm	P mm	H mm	cassetti						RAL	€
				n.	h 75 mm	h 150 mm	h 200 mm				
MBR05SC010304PD	713	610	669	4	1	2	1	100-75-50	92-96-100%	7035+7016	556,20



Armadio L=713 mm con 5 cassetti 1x75 3x100 1x200



ART.	L mm	P mm	H mm	cassetti						RAL	€
				n.	h 75 mm	h 100 mm	h 200 mm				
MBR05SC010305PD	713	610	669	5	1	3	1	100-75-50	92-96-100%	7035+7016	630,60



Armadi con cassetti

L  713 mm

36x27 EH



Armadio L=713 mm predisposto per porta con 1 piano regolabile

ART.	L mm	P mm	H mm	RAL	€
MBR05SX00030708	713	610	669	7035	219,90



Porta totale sinistra H=600 mm con maniglia Dark Grey

ART.	L mm	P mm	H mm	apertura	RAL	€
MBR06SC01030239	657	34	600	Sinistra	7016	57,00





Porta totale destra H=600 mm con maniglia Dark Grey

ART.	L mm	P mm	H mm	apertura	RAL	€
MBR06SC01030139	657	34	600	Destra	7016	57,00



Armadio L=713 mm predisposto per porta con 1 cassetto H=150 mm

ART.	L mm	P mm	H mm	cassetti			RAL	€
				h 150 mm	 KG			
MBR05SC010306PD	713	610	669	1	100-75-50	92-96-100%	7035+7016	310,20



Porta parziale sinistra H=435 mm con maniglia Dark Grey

ART.	L mm	P mm	H mm	apertura	RAL	€
MBR06SC01030439	657	34	435	Sinistra	7016	54,00



Porta parziale destra H=435 mm con maniglia Dark Grey

ART.	L mm	P mm	H mm	apertura	RAL	€
MBR06SC01030339	657	34	435	Destra	7016	54,00



RAL 7035 + RAL 7016



RAL 7016



RAL 7035



ESTRAZIONE



PORTATA



### Pannello forato laterale

ART.	L mm	P mm	H mm	Dim. foro mm	RAL	€
FBG15S00V0V0008	610	75	669	10x10	7035	43,50



### Piano aggiuntivo

ART.	L mm	P mm	H mm	KG	RAL	€
MBR08S070600008	713	605	35	250	7035	42,00
MBR08S090600008	967	605	35	250	7035	52,50
MBR08S110600008	1120	605	35	250	7035	52,50
MBR08S120600008	1273	605	35	250	7035	55,50
MBR08S160600008	1680	605	35	200	7035	70,50



### Semipiano aggiuntivo

ART.	L mm	P mm	H mm	KG	RAL	€
MBR09S050300008	560	305	35	100	7035	28,50
MBR09S070300008	713	305	35	100	7035	28,50
MBR09S090300008	967	305	35	100	7035	32,70
MBR09S110300008	1120	305	35	100	7035	32,70
MBR09S120300008	1273	305	35	100	7035	37,20
MBR09S160300008	1680	305	35	100	7035	45,00



### Supporto semipiano intermedio

ART.	L mm	P mm	H mm	RAL	€
FBG13S605V00008	605	77	35	7035	9,30

Modulo componibile



1. Piano interno 27x27 EH
2. Piano superiore e inferiore 27x27 EH
3. Supporto semipiano intermedio
4. Porta totale destra H=600 mm con maniglia Dark Grey
5. Porta totale sinistra H=600 mm con maniglia Dark Grey

### Piano interno 27x27 EH

ART.	L mm	P mm	H mm	KG	RAL	€
MBR11S0V0020008	558	466	60	100	7035	27,30



### Piano superiore e inferiore 27x27 EH

ART.	L mm	P mm	H mm	KG	RAL	€
MBR10S050600008	560	610	32	100	7035	31,20



### Porta totale destra H=600 mm con maniglia Dark Grey

ART.	L mm	P mm	H mm	apertura	RAL	€
MBR06SC01020539	554	34	600	Destra	7016	54,00



### Supporto semipiano intermedio

ART.	Lmm	Pmm	Hmm	RAL	€
FBG13S605V00008	605	77	35	7035	9,30



### Porta totale sinistra H=600 mm con maniglia Dark Grey

ART.	L mm	P mm	H mm	apertura	RAL	€
MBR06SC01020639	554	34	600	Sinistra	7016	54,00

 RAL 7016

 RAL 7035

 PORTATA

# WORK MASTER BR MATERIALE DI SEPARAZIONE

L= 560 MM 27X27 EH



ART.	adatto per cassetto H mm	componenti	€
FFH84050200	50/300	16 x Divisorio trasversale L=36 mm 7 x Divisorio trasversale L=47 mm 6 x Divisorio a 3 canali 3 x Divisorio a 4 canali	21,30



ART.	adatto per cassetto H mm	componenti	€
FFH84050300	50/300	15 x Divisorio trasversale L=47 mm 8 x Divisorio trasversale L=73 mm 6 x Divisorio a 2 canali 3 x Divisorio a 3 canali	21,30



ART.	adatto per cassetto H mm	componenti	€
FFH84050400	50/300	18 x Divisorio trasversale L=73 mm 9 x Divisorio a 2 canali	20,40



ART.	adatto per cassetto H mm	componenti	€
FFH84071800	75	6 x Cassetta divisorio 150x75 mm	21,90
FFH84101800	100/125	6 x Cassetta divisorio 150x150 mm	24,00



ART.	adatto per cassetto H mm	componenti	€
FFH84070800	75		12,60
FFH84100800	100/125	2 x Divisorio longitudinale fessurato L=457 mm 3 x Divisorio trasversale L=151 mm	15,30
FFH84150800	150/175		19,80
FFH84200800	200/250		28,80

# WORK MASTER BR MATERIALE DI SEPARAZIONE

L= 713 MM 36X27 EH



ART.	adatto per cassetto H mm	componenti	€
FFH10051000	50/300	3 x Divisorio a 3 canali 9 x Divisorio a 4 canali 12 x Divisorio trasversale L=47 mm 36 x Divisorio trasversale L=36 mm	30,00



ART.	adatto per cassetto H mm	componenti	€
FFH10051300	50/300	18 x Divisorio trasversale L=47 mm 12 x Divisorio trasversale L=73 mm 6 x Divisorio a 2 canali 6 x Divisorio a 3 canali	27,00



ART.	adatto per cassetto H mm	componenti	€
FFH10051500	50/300	20 x Divisorio trasversale L=36 mm 20 x Divisorio trasversale L=47 mm 6 x Divisorio a 3 canali 5 x Divisorio a 4 canali 1 x Porta chiavi a brugola	30,00



ART.	adatto per cassetto H mm	componenti	€
FFH10071800	75	16 x Cassetta divisorio 75x75 mm 8 x Cassetta divisorio 150x75 mm 4 x Cassetta divisorio 150x150 mm	30,60

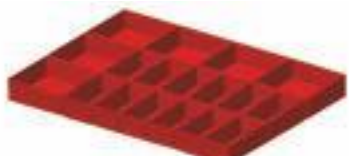

ART.	adatto per cassetto H mm	componenti	€
FFH10071600	75	12 x Cassetta divisorio 150x75 mm 6 x Cassetta divisorio 150x150 mm	27,90
FFH10101600	100/125		32,70



ART.	adatto per cassetto H mm	componenti	€
FFH10070500	75	2 x Divisorio longitudinale fessurato L=457 mm 3 x Divisorio trasversale L=202 mm	15,30
FFH10100500	100/125		15,90
FFH10150500	150/175		21,30
FFH10200500	200/250		30,30



# WORK MASTER BR



ART.	L mm	P mm	H mm	KG	RAL	€
MASTERBR3001	3206	750	1985/2360	1000	7035+7016	4665,90

Composto da:

qtà	descrizione
1	Banco smontato con piano in multiplex 40 mm
1	Armadio L=560 mm predisposto per porta con 1 piano regolabile
2	Armadio L=713 mm con 4 cassetti 1x75 2x150 1x200
1	Armadio tecnico L=560 mm predisposto per porta
1	Porta parziale destra H=435 mm con maniglia Dark Grey
1	Porta totale sinistra H=600 mm con maniglia Dark Grey
2	Pannello forato laterale
1	Kit 3 montanti biasolati
2	Kit 3 pannelli forati/mensole con 2 bordi fermacasse
2	Lampada doppia
2	Pensile con porta
1	Multipresa schuko a 2 scomparti
1	Cavo di collegamento wieland schuko/francese

qtà	descrizione
1	Tasca porta documenti A4
1	Kit porta rotolo con carta Ø=240 mm
4	Porta bombolette inclinato a 2 posti
6	Gancio Unipok per utensili - confezione 30 pezzi
1	Barra aggancio con 4 contenitori Picking Box misura 1
2	Mensola grande reversibile
1	Cestino capacità 30 L
3	Kit 2 contenitori Picking Box misura 3A2
1	Piastra per arrotolatore
2	Rullo per arrotolatore
1	Arrotolatore per aria compressa
1	Arrotolatore elettrico con presa Schuko
1	Kit 3 supporti inclinati con 2 binari

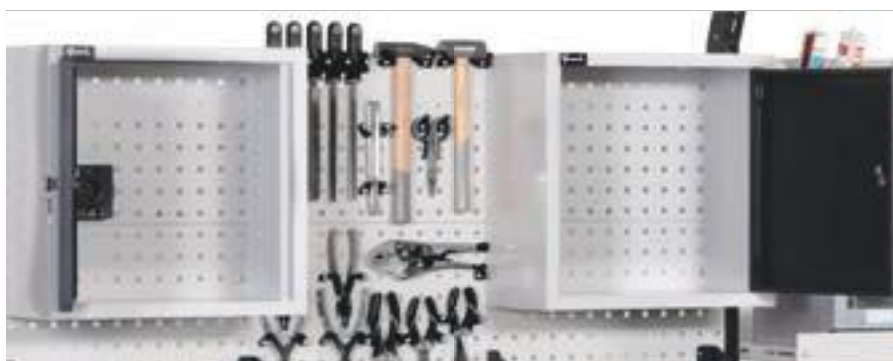



# WORK MASTER BR



ART.	Lmm	Pmm	Hmm	KG	RAL	€
<b>MASTERBR1508</b>	1706	750	1985/2360	1000	7035+7016	2136,60

Composto da:

qtà	descrizione
1	Banco smontato con piano in multiplex 40 mm
1	Armadio L=560 mm con 5 cassetti 1x75 3x100 1x200
2	Piano superiore/inferiore L=560 mm
1	Porta totale sinistra H=600 mm con maniglia Dark Grey
1	Supporto semipiano intermedio
1	Piano interno L=558 mm
2	Pannello forato laterale
1	Supporto multipresa a 2 scomparti
1	Supporto multipresa a 4 scomparti
1	Multipresa schuko a 2 scomparti
1	Multipresa schuko a 4 scomparti

qtà	descrizione
1	Cavo di collegamento wieland schuko/francese
1	Tasca porta documenti A4
1	Kit porta rotolo con carta Ø=240 mm
2	Porta bombolette inclinato a 2 posti
4	Gancio Unipok per utensili - confezione 30 pezzi
1	Cestino capacità 30 L
2	Pensile con porta
1	Lampada doppia
1	Kit 3 pannelli forati/mensole con 2 bordi fermacasse
1	Kit 2 supporti inclinati con binario
1	Kit 2 montanti biasolati



RAL 7035 + RAL 7016



PORTATA

# WORK-WORK UP

## BANCHI DA LAVORO

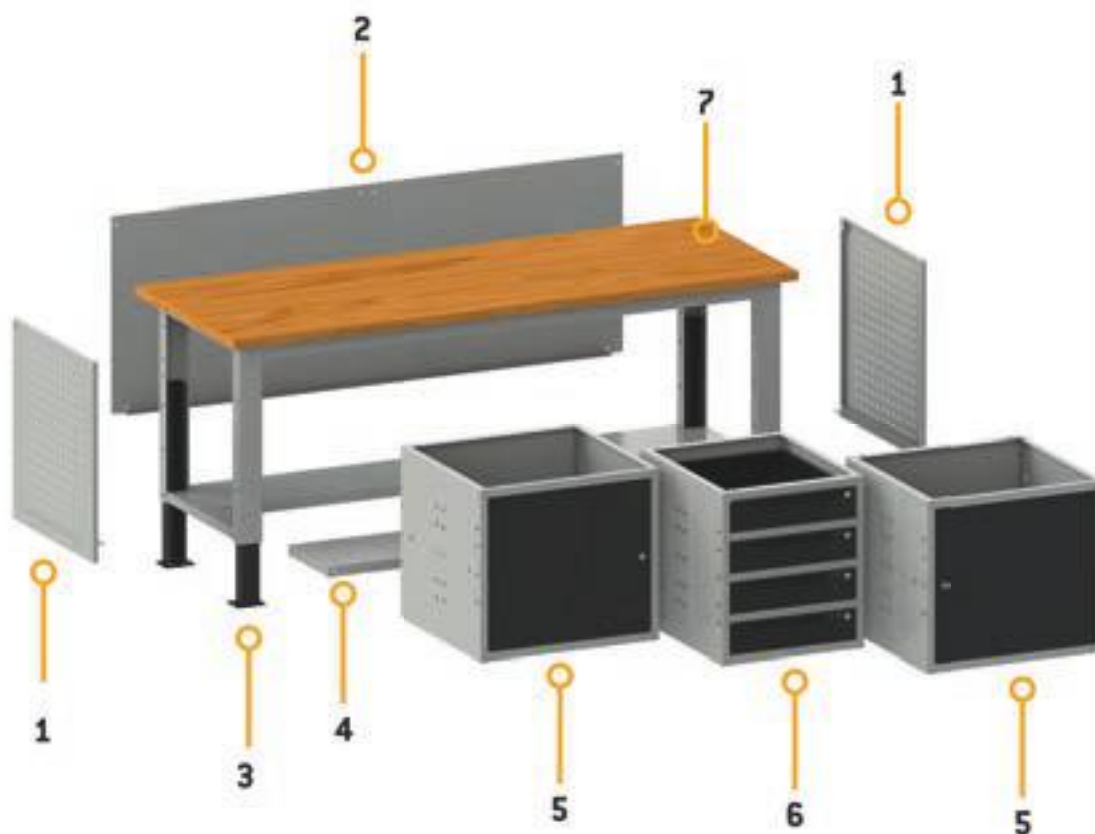

1. Pannello forato laterale
2. Chiusura posteriore
3. Gambe regolabili
4. Semipiano aggiuntivo

5. Armadio con porta
6. Armadio a 4 cassetti
7. Piano in Multiplex



**Cassetti ad estrazione semplice**

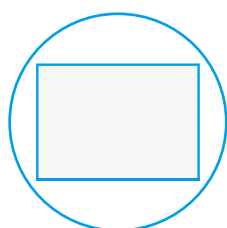

**Fondo cassetto liscio**

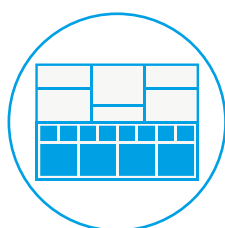

**Materiale di separazione**



**Chiusura a chiave**

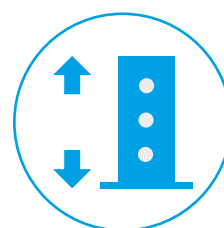

**Gambe regolabili in altezza**

## Configurazioni alternative



Utensili esclusi



ART.	L mm	P mm	H mm	KG	RAL	€
<b>WORK2043</b>	2307	750	1977/2352	1000	7035+7016	2030,10

Composto da:

qtà	descrizione	qtà	descrizione
1	Banco smontato regolabile con piano in multiplex 30 mm	2	Kit 3 pannelli forati/mensole con 2 bordi fermacasse
2	Armadio L=629 mm con 1 porta e 1 piano regolabile	1	Lampada doppia
1	Armadio L=500 mm con 3 cassetti H=150 mm	2	Porta bombolette inclinato a 2 posti
1	Semipiano non fessurato L=1760 mm	1	Kit porta rotolo con carta Ø=240 mm
2	Pannello forato laterale	7	Gancio Unipok per utensili - confezione 30 pezzi
1	Cestino capacità 30 L	1	Supporto multipresa a 4 scomparti
2	Porta silicone inclinato a 2 posti	1	Multipresa schuko a 4 scomparti
1	Tasca porta documenti A4	1	Cavo di collegamento wieland schuko/francese
1	Kit 3 montanti biasolati	1	Mensola grande reversibile
1	Kit 3 supporti inclinati con 2 binari		







RAL 7035 + RAL 7016



PORTATA

# WORK UP 1500

-  **1000 kg**
-  **regolabili in altezza**
-  **piano in multiplex spessore 30 mm**
-  **Forniti smontati**
-  **passo fori gambe 25 mm**



ART.	L mm	P mm	H mm	RAL	€
<b>WORK1501</b>	1500	750	732/1107	7035+7016	405,90
<b>WORK1502</b>	1500	750	732/1107	5012	395,40

Composto da:

qtà	descrizione
1	Banco smontato regolabile con piano in multiplex 30 mm
1	Armadio L=500 mm con 1 cassetto H=150 mm



ART.	L mm	P mm	H mm	RAL	€
<b>WORK1503</b>	1500	750	732/1107	7035+7016	676,50
<b>WORK1504</b>	1500	750	732/1107	5012	651,90

Composto da:

qtà	descrizione
1	Banco smontato regolabile con piano in multiplex 30 mm
1	Armadio L=500 mm con 4 cassetti H=105 mm
1	Semipiano non fessurato L=1260 mm



ART.	L mm	P mm	H mm	RAL	€
<b>WORK1507</b>	1500	750	732/1107	7035+7016	732,30
<b>WORK1508</b>	1500	750	732/1107	5012	707,70

Composto da:

qtà	descrizione
1	Banco smontato regolabile con piano in multiplex 30 mm
1	Armadio L=500 mm con 4 cassetti H=105 mm
1	Chiusura posteriore
1	Semipiano non fessurato L=760 mm
1	Supporto semipiano intermedio

# WORK UP 1500

## Esempi di configurazione



Utensili esclusi



Utensili esclusi



Utensili esclusi



ART.	L mm	P mm	H mm	RAL	€
<b>WORK1528</b>	1500	750	1675/2050	7035+7016	715,50
<b>WORK1534</b>	1500	750	1675/2050	5012	705,00

Composto da:

qtà	descrizione
1	Banco smontato regolabile con piano in multiplex 30 mm
1	Armadio L=500 mm con 1 cassetto H=150 mm
1	Kit 2 montanti biasolati
1	Kit 3 pannelli forati/mensole con 2 bordi fermacasse
6	Gancio Unipok per utensili - confezione 30 pezzi
2	Barra aggancio con 4 contenitori Picking Box misura 1

ART.	L mm	P mm	H mm	RAL	€
<b>WORK1529</b>	1500	750	1675/2050	7035+7016	986,10
<b>WORK1535</b>	1500	750	1675/2050	5012	961,50

Composto da:

qtà	descrizione
1	Banco smontato regolabile con piano in multiplex 30 mm
1	Armadio L=500 mm con 4 cassetti H=105 mm
1	Semipiano non fessurato L=1260 mm
1	Kit 2 montanti biasolati
1	Kit 3 pannelli forati/mensole con 2 bordi fermacasse
6	Gancio Unipok per utensili - confezione 30 pezzi
2	Barra aggancio con 4 contenitori Picking Box misura 1





ART.	L mm	P mm	H mm	RAL	€
<b>WORK1530</b>	1500	750	1675/2050	7035+7016	1041,90
<b>WORK1536</b>	1500	750	1675/2050	5012	1017,30

Composto da:

qtà	descrizione
1	Banco smontato regolabile con piano in multiplex 30 mm
1	Chiusura posteriore
1	Armadio L=500 mm con 4 cassetti H=105 mm
1	Semipiano non fessurato L=760 mm
1	Supporto semipiano intermedio
1	Kit 2 montanti biasolati
1	Kit 3 pannelli forati/mensole con 2 bordi fermacasse
6	Gancio Unipok per utensili - confezione 30 pezzi
2	Barra aggancio con 4 contenitori Picking Box misura 1

  
 RAL 5012      RAL 7035+RAL 7016

# WORK UP 1500

-  **1000 kg**
-  **regolabili in altezza**
-  **piano in multiplex spessore 30 mm**
-  **Forniti smontati**
-  **passo fori gambe 25 mm**



ART.	L mm	P mm	H mm	RAL	€
<b>WORK1505</b>	1500	750	732/1107	7035+7016	809,40
<b>WORK1506</b>	1500	750	732/1107	5012	781,80

Composto da:

qtà	descrizione
1	Banco smontato regolabile con piano in multiplex 30 mm
1	Armadio L=500 mm con 4 cassetti H=105 mm
1	Armadio L=500 mm con 1 porta e 1 piano regolabile
1	Fondo di chiusura per armadio L=500 mm



ART.	L mm	P mm	H mm	RAL	€
<b>WORK1511</b>	1500	750	732/1107	7035+7016	707,40
<b>WORK1512</b>	1500	750	732/1107	5012	689,40

Composto da:

qtà	descrizione
1	Banco smontato regolabile con piano in multiplex 30 mm
2	Armadio L=629 mm con 1 cassetto H=150 mm e 1 porta
1	Semipiano non fessurato L=1260 mm



ART.	L mm	P mm	H mm	RAL	€
<b>WORK1509</b>	1500	750	732/1107	7035+7016	846,60
<b>WORK1510</b>	1500	750	732/1107	5012	819,00

Composto da:

qtà	descrizione
1	Banco smontato regolabile con piano in multiplex 30 mm
1	Armadio L=629 mm con 4 cassetti H=105 mm
1	Armadio L=629 mm con 1 porta e 1 piano regolabile
1	Semipiano non fessurato L=1260 mm



# WORK UP 1500

## Esempi di configurazione



Utensili esclusi



Utensili esclusi



Utensili esclusi



ART.	L mm	P mm	H mm	RAL	€
<b>WORK1531</b>	1500	750	1675/2050	7035+7016	1119,00
<b>WORK1537</b>	1500	750	1675/2050	5012	1091,40

Composto da:

qtà	descrizione
1	Banco smontato regolabile con piano in multiplex 30 mm
1	Armadio L=500 mm con 1 porta e 1 piano regolabile
1	Fondo di chiusura per armadio L=500 mm
1	Armadio L=500 mm con 4 cassetti H=105 mm
1	Kit 2 montanti biasolati
1	Kit 3 pannelli forati/mensole con 2 bordi fermacasse
6	Gancio Unipok per utensili - confezione 30 pezzi
2	Barra aggancio con 4 contenitori Picking Box misura 1

ART.	L mm	P mm	H mm	RAL	€
<b>WORK1532</b>	1500	750	1675/2050	7035+7016	1017,00
<b>WORK1538</b>	1500	750	1675/2050	5012	999,00

Composto da:

qtà	descrizione
1	Banco smontato regolabile con piano in multiplex 30 mm
2	Armadio L=629 mm con 1 cassetto H=150 mm e 1 porta
1	Semipiano non fessurato L=1260 mm
1	Kit 2 montanti biasolati
1	Kit 3 pannelli forati/mensole con 2 bordi fermacasse
6	Gancio Unipok per utensili - confezione 30 pezzi
2	Barra aggancio con 4 contenitori Picking Box misura 1





ART.	L mm	P mm	H mm	RAL	€
<b>WORK1533</b>	1500	750	1675/2050	7035+7016	1156,20
<b>WORK1539</b>	1500	750	1675/2050	5012	1128,60

Composto da:

qtà	descrizione
1	Banco smontato regolabile con piano in multiplex 30 mm
1	Armadio L=629 mm con 1 porta e 1 piano regolabile
1	Armadio L=629 mm con 4 cassetti H=105 mm
1	Semipiano non fessurato L=1260 mm
1	Kit 2 montanti biasolati
1	Kit 3 pannelli forati/mensole con 2 bordi fermacasse
6	Gancio Unipok per utensili - confezione 30 pezzi
2	Barra aggancio con 4 contenitori Picking Box misura 1

  
 RAL 5012      RAL 7035+RAL 7016

# WORK UP 2000

-  **1000 kg**
-  **regolabili in altezza**
-  **piano in multiplex spessore 30 mm**
-  **Forniti smontati**
-  **passo fori gambe 25 mm**



ART.	L mm	P mm	H mm	RAL	€
<b>WORK2001</b>	2000	750	732/1107	7035+7016	447,30
<b>WORK2002</b>	2000	750	732/1107	5012	439,80

Composto da:

qtà	descrizione
1	Banco smontato regolabile con piano in multiplex 30 mm
1	Armadio L=500 mm con 1 cassetto H=150 mm



ART.	L mm	P mm	H mm	RAL	€
<b>WORK2003</b>	2000	750	732/1107	7035+7016	727,20
<b>WORK2004</b>	2000	750	732/1107	5012	705,60

Composto da:

qtà	descrizione
1	Banco smontato regolabile con piano in multiplex 30 mm
1	Armadio L=500 mm con 4 cassetti H=105 mm
1	Semipiano non fessurato L=1760 mm



ART.	L mm	P mm	H mm	RAL	€
<b>WORK2005</b>	2000	750	732/1107	7035+7016	866,40
<b>WORK2006</b>	2000	750	732/1107	5012	841,80

Composto da:

qtà	descrizione
1	Banco smontato regolabile con piano in multiplex 30 mm
1	Armadio L=500 mm con 4 cassetti H=105 mm
1	Armadio L=500 mm con 1 porta e 1 piano regolabile
1	Semipiano non fessurato L=1760 mm



# WORK UP 2000

## Esempi di configurazione

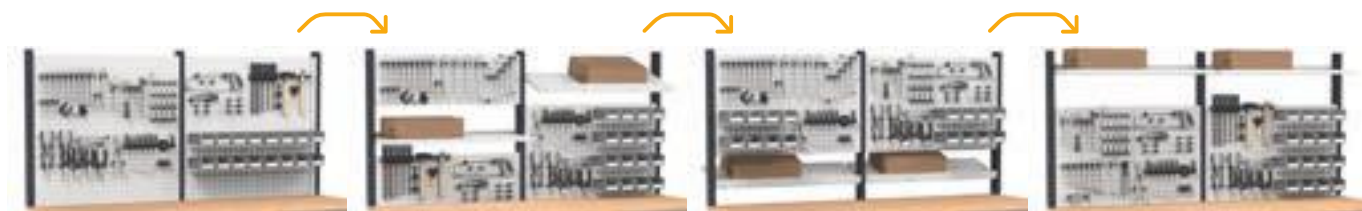

Utensili esclusi



Utensili esclusi



Utensili esclusi



ART.	L mm	P mm	H mm	RAL	€
<b>WORK2030</b>	2000	750	1675/2050	7035+7016	879,90
<b>WORK2036</b>	2000	750	1675/2050	5012	872,40

Composto da:

qtà	descrizione
1	Banco smontato regolabile con piano in multiplex 30 mm
1	Armadio L=500 mm con 1 cassetto H=150 mm
1	Kit 3 montanti biasolati
2	Kit 3 pannelli forati/mensole con 2 bordi fermacasse
6	Gancio Unipok per utensili - confezione 30 pezzi
4	Barra aggancio con 4 contenitori Picking Box misura 1

ART.	L mm	P mm	H mm	RAL	€
<b>WORK2031</b>	2000	750	1675/2050	7035+7016	1159,80
<b>WORK2037</b>	2000	750	1675/2050	5012	1138,20

Composto da:

qtà	descrizione
1	Banco smontato regolabile con piano in multiplex 30 mm
1	Armadio L=500 mm con 4 cassette H=105 mm
1	Semipiano non fessurato L=1760 mm
1	Kit 3 montanti biasolati
2	Kit 3 pannelli forati/mensole con 2 bordi fermacasse
6	Gancio Unipok per utensili - confezione 30 pezzi
4	Barra aggancio con 4 contenitori Picking Box misura 1





ART.	L mm	P mm	H mm	RAL	€
<b>WORK2032</b>	2000	750	1675/2050	7035+7016	1299,00
<b>WORK2038</b>	2000	750	1675/2050	5012	1274,40

Composto da:

qtà	descrizione
1	Banco smontato regolabile con piano in multiplex 30 mm
1	Armadio L=500 mm con 1 porta e 1 piano regolabile
1	Armadio L=500 mm con 4 cassette H=105 mm
1	Semipiano non fessurato L=1760 mm
1	Kit 3 montanti biasolati
2	Kit 3 pannelli forati/mensole con 2 bordi fermacasse
6	Gancio Unipok per utensili - confezione 30 pezzi
4	Barra aggancio con 4 contenitori Picking Box misura 1

  
 RAL 5012      RAL 7035+RAL 7016

# WORK UP 2000

-  **1000 kg**
-  **regolabili in altezza**
-  **piano in multiplex spessore 30 mm**
-  **Forniti smontati**
-  **passo fori gambe 25 mm**



ART.	L mm	P mm	H mm	RAL	€
<b>WORK2007</b>	2000	750	732/1107	7035+7016	953,10
<b>WORK2008</b>	2000	750	732/1107	5012	928,50

Composto da:

qtà	descrizione
1	Banco smontato regolabile con piano in multiplex 30 mm
1	Armadio L=500 mm con 4 cassetti H=105 mm
1	Armadio L=500 mm con 1 porta e 1 piano regolabile
1	Chiusura posteriore
1	Semipiano non fessurato L=760 mm
1	Fondo di chiusura per armadio L=500 mm



ART.	L mm	P mm	H mm	RAL	€
<b>WORK2011</b>	2000	750	732/1107	7035+7016	925,20
<b>WORK2012</b>	2000	750	732/1107	5012	900,90

Composto da:

qtà	descrizione
1	Banco smontato regolabile con piano in multiplex 30 mm
1	Armadio L=500 mm con 1 cassetto H=150 mm e 1 porta
2	Armadio L=629 mm con 1 cassetto H=150 mm e 1 porta
1	Semipiano non fessurato L=1760 mm



ART.	L mm	P mm	H mm	RAL	€
<b>WORK2009</b>	2000	750	732/1107	7035+7016	1030,20
<b>WORK2010</b>	2000	750	732/1107	5012	1002,60

Composto da:

qtà	descrizione
1	Banco smontato regolabile con piano in multiplex 30 mm
1	Armadio L=500 mm con 4 cassetti H=105 mm
2	Armadio L=629 mm con 1 porta e 1 piano regolabile
1	Semipiano non fessurato L=1760 mm

# WORK UP 2000

## Esempi di configurazione

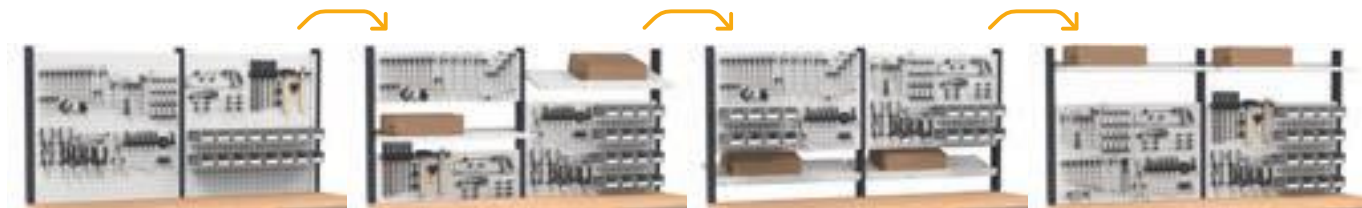

Utensili esclusi



Utensili esclusi



Utensili esclusi



ART.	L mm	P mm	H mm	RAL	€
<b>WORK2033</b>	2000	750	1675/2050	7035+7016	1385,70
<b>WORK2039</b>	2000	750	1675/2050	5012	1361,10

Composto da:

qtà	descrizione
1	Banco smontato regolabile con piano in multiplex 30 mm
1	Chiusura posteriore
1	Armadio L=500 mm con 1 porta e 1 piano regolabile
1	Fondo di chiusura per armadio L=500 mm
1	Armadio L=500 mm con 4 cassetti H=105 mm
1	Semipiano non fessurato L=760 mm
1	Kit 3 montanti biasolati
2	Kit 3 pannelli forati/mensole con 2 bordi fermacasse
6	Gancio Unipok per utensili - confezione 30 pezzi
4	Barra aggancio con 4 contenitori Picking Box misura 1

ART.	L mm	P mm	H mm	RAL	€
<b>WORK2034</b>	2000	750	1675/2050	7035+7016	1357,80
<b>WORK2040</b>	2000	750	1675/2050	5012	1333,50

Composto da:







qtà	descrizione
1	Banco smontato regolabile con piano in multiplex 30 mm
2	Armadio L=629 mm con 1 cassetto H=150 mm e 1 porta
1	Armadio L=500 mm con 1 cassetto H=150 mm e 1 porta
1	Semipiano non fessurato L=1760 mm
1	Kit 3 montanti biasolati
2	Kit 3 pannelli forati/mensole con 2 bordi fermacasse
6	Gancio Unipok per utensili - confezione 30 pezzi
4	Barra aggancio con 4 contenitori Picking Box misura 1

ART.	L mm	P mm	H mm	RAL	€
<b>WORK2035</b>	2000	750	1675/2050	7035+7016	1462,80
<b>WORK2041</b>	2000	750	1675/2050	5012	1435,20

Composto da:

qtà	descrizione
1	Banco smontato regolabile con piano in multiplex 30 mm
2	Armadio L=629 mm con 1 porta e 1 piano regolabile
1	Armadio L=500 mm con 4 cassetti H=105 mm
1	Semipiano non fessurato L=1760 mm
1	Kit 3 montanti biasolati
2	Kit 3 pannelli forati/mensole con 2 bordi fermacasse
6	Gancio Unipok per utensili - confezione 30 pezzi
4	Barra aggancio con 4 contenitori Picking Box misura 1

  
 RAL 5012      RAL 7035 + RAL 7016

-  **1000 kg**
-  **regolabili in altezza**
-  **piano in multiplex spessore 30 mm**
-  **Forniti smontati**
-  **passo fori gambe 25 mm**
-  **piano in acciaio spessore 3 mm**



### Banco Work Up con piano in acciaio

ART.	L mm	P mm	H mm	piano		RAL	€
				materiale	mm		
FBG01S1000R00PD	1031	704	737/1112	Acciaio	3	7035+7016	264,00
FBG01S1000R0004	1031	704	737/1112	Acciaio	3	5012	251,40
FBG01S1500R00PD	1507	704	737/1112	Acciaio	3	7035+7016	318,00
FBG01S1500R0004	1507	704	737/1112	Acciaio	3	5012	299,40
FBG01S2000R00PD	2007	704	737/1112	Acciaio	3	7035+7016	359,40
FBG01S2000R0004	2007	704	737/1112	Acciaio	3	5012	343,80



### Banco Work Up con piano in legno

ART.	L mm	P mm	H mm	piano		RAL	€
				materiale	mm		
FBG02S1000R00PD	1024	750	732/1107	Multiplex	30	7035+7016	264,00
FBG02S1000R0004	1024	750	732/1107	Multiplex	30	5012	251,40
FBG02S1500R00PD	1500	750	732/1107	Multiplex	30	7035+7016	305,40
FBG02S1500R0004	1500	750	732/1107	Multiplex	30	5012	299,40
FBG02S2000R00PD	2000	750	732/1107	Multiplex	30	7035+7016	346,80
FBG02S2000R0004	2000	750	732/1107	Multiplex	30	5012	343,80



### Imballo banco smontato

#### Kit ruote

Adatte solo per i banchi Work Up



ART.	Ø mm	KG	H mm	materiale			€
FKRU1252101	125	300	155	Gomma antitraccia sintetica	2	2	53,40
FKRS1252101	125	750	155	Gomma elastica	2	2	85,20



RUOTA GIREVOLE CON FRENO



RUOTA FISSA

### Coppia squadre di rinforzo

ART.	L mm	P mm	H mm	RAL	€
FBGKITS0008	145	39	145	7035	16,50
FBGKITS0004	145	39	145	5012	16,50



Utilizzare una coppia squadre per gamba se non è presente la cassetiera



 **1000 kg**

 **piano in multiplex spessore 30 mm**

 **Forniti smontati**

 **piano in acciaio spessore 3 mm**



### Banco Work con piano in acciaio

ART.	L mm	P mm	H mm	piano		RAL	€
				materiale	mm		
FBG01S1000F00PD	1031	704	887	Acciaio	3	7035+7016	222,60
FBG01S1000F0004	1031	704	887	Acciaio	3	5012	216,30
FBG01S1500F00PD	1507	704	887	Acciaio	3	7035+7016	283,20
FBG01S1500F0004	1507	704	887	Acciaio	3	5012	270,60
FBG01S2000F00PD	2007	704	887	Acciaio	3	7035+7016	331,20
FBG01S2000F0004	2007	704	887	Acciaio	3	5012	315,00



### Banco Work con piano in legno

ART.	L mm	P mm	H mm	piano		RAL	€
				materiale	mm		
FBG02S1000F0008	1024	750	882	Multiplex	30	7035	216,30
FBG02S1000F0004	1024	750	882	Multiplex	30	5012	216,30
FBG02S1500F0008	1500	750	882	Multiplex	30	7035	270,60
FBG02S1500F0004	1500	750	882	Multiplex	30	5012	270,60
FBG02S2000F0008	2000	750	882	Multiplex	30	7035	315,00
FBG02S2000F0004	2000	750	882	Multiplex	30	5012	315,00



### Imballo banco smontato



### Copertura per piano in acciaio

ART.	L mm	P mm	H mm	colore	€
FBG32100007	1024	702	27	Nero	80,40
FBG32150007	1500	702	27	Nero	111,30
FBG32200007	2000	702	27	Nero	142,20



### Copertura per piano in multiplex

ART.	L mm	P mm	H mm	colore	€
FBL22300007	1028	754	22	Nero	80,40
FBL22600007	1504	754	22	Nero	111,30
FBL22900007	2004	754	22	Nero	142,20
FBL23200007	3004	754	22	Nero	266,10

 RAL 5012

 RAL 7035

 RAL 7035 + RAL 7016

 SPESSORE

 PORTATA

### 1000



### 1500



### Armadi con cassetti

L → 500 mm

#### Armadio con 1 cassetto



ART.	L mm	P mm	H mm	cassetti				porta		RAL	€
				n.	KG	↕	h mm	n.	h ingresso mm		
FBG03S50C0001PD	500	630	210	1	80	86%	150	-	-	7035+7016	100,50
FBG03S50C000104	500	630	210	1	80	86%	150	-	-	5012	96,00

#### Armadio con 3 cassetti



ART.	L mm	P mm	H mm	cassetti				porta		RAL	€
				n.	KG	↕	h mm	n.	h ingresso mm		
FBG03S50C0002PD	500	630	570	3	80	86%	150	-	-	7035+7016	244,20
FBG03S50C000204	500	630	570	3	80	86%	150	-	-	5012	230,40

#### Armadio con 4 cassetti



ART.	L mm	P mm	H mm	cassetti				porta		RAL	€
				n.	KG	↕	h mm	n.	h ingresso mm		
FBG03S50C0003PD	500	630	570	4	80	86%	105	-	-	7035+7016	333,90
FBG03S50C000304	500	630	570	4	80	86%	105	-	-	5012	315,30

#### Armadio con 1 cassetto e 1 porta



ART.	L mm	P mm	H mm	cassetti				porta		RAL	€
				n.	KG	↕	h mm	n.	h ingresso mm		
FBG03S50C0004PD	500	630	570	1	80	86%	150	1	310	7035+7016	167,10
FBG03S50C000404	500	630	570	1	80	86%	150	1	310	5012	157,80

⚠ Senza fondo di chiusura

#### Armadio con 1 porta e 1 piano



ART.	L mm	P mm	H mm	cassetti				porta		RAL	€
				n.	KG	↕	h mm	n.	h ingresso mm		
FBG03S50C0005PD	500	612	570	-	-	-%	-	1	491	7035+7016	139,20
FBG03S50C000504	500	612	570	-	-	-%	-	1	491	5012	136,20

⚠ Senza fondo di chiusura



## Fondo di chiusura



### Fondo di chiusura per armadi L= 500 mm

ART.	L mm	P mm	H mm	RAL	€
FBG16S50V0V0008	494	572	4	7035	30,90
FBG16S50V0V0004	494	572	4	5012	30,90

⚠ Da utilizzare sull'armadio con porta quando è presente il semipiano



### Fondo di chiusura per armadi L= 629 mm

ART.	L mm	P mm	H mm	RAL	€
FBG16S63V0V0008	623	572	4	7035	30,90
FBG16S63V0V0004	623	572	4	5012	30,90

⚠ Da utilizzare sull'armadio con porta quando è presente il semipiano



## Armadri con cassetti

L → 629 mm



### Armadio con 3 cassetti

ART.	L mm	P mm	H mm	cassetti				porta		RAL	€
				n.	KG	↕	h mm	n.	h ingresso mm		
FBG03S63C0002PD	629	630	570	3	80	86%	150	-	-	7035+7016	272,10
FBG03S63C000204	629	630	570	3	80	86%	150	-	-	5012	256,50



### Armadio con 4 cassetti

ART.	L mm	P mm	H mm	cassetti				porta		RAL	€
				n.	KG	↕	h mm	n.	h ingresso mm		
FBG03S63C0003PD	629	630	570	4	80	86%	105	-	-	7035+7016	352,50
FBG03S63C000304	629	630	570	4	80	86%	105	-	-	5012	333,90



### Armadio con 1 cassetto e 1 porta

ART.	L mm	P mm	H mm	cassetti				porta		RAL	€
				n.	KG	↕	h mm	n.	h ingresso mm		
FBG03S63C0004PD	629	630	570	1	80	86%	150	1	310	7035+7016	182,40
FBG03S63C000404	629	630	570	1	80	86%	150	1	310	5012	176,40

⚠ Senza fondo di chiusura



### Armadio con 1 porta e 1 piano

ART.	L mm	P mm	H mm	cassetti				porta		RAL	€
				n.	KG	↕	h mm	n.	h ingresso mm		
FBG03S63C0005PD	629	612	570	-	-	-%	-	1	491	7035+7016	151,50
FBG03S63C000504	629	612	570	-	-	-%	-	1	491	5012	148,50

⚠ Senza fondo di chiusura

 RAL 5012    
  RAL 7035    
  RAL 7035 + RAL 7016    
  PORTATA    
  ESTRAZIONE



## Chiusura posteriore



ART.	L mm	H mm	adatto per banco L mm	RAL	€
FBG12S080000008	825	665	1024-1031	7035	45,00
FBG12S080000004	825	665	1024-1031	5012	45,00
FBG12S130000008	1325	665	1500-1507	7035	54,30
FBG12S130000004	1325	665	1500-1507	5012	54,30
FBG12S180000008	1825	665	2000-2007	7035	72,90
FBG12S180000004	1825	665	2000-2007	5012	72,90



## Coppia tamponi laterali

Per banco L=1024-1031 mm con armadio L=629 mm

ART.	L mm	P mm	H mm	RAL	€
FBG14S130V00008	65	35	568	7035	17,10
FBG14S130V00004	65	35	568	5012	17,10



## Pannello forato laterale

ART.	L mm	P mm	H mm	Dim. foro mm	RAL	€
FBG15S00V0V0008	610	75	669	10x10	7035	43,50
FBG15S00V0V0004	610	75	669	10x10	5012	43,50

## Piano non fessurato aggiuntivo

ART.	L mm	P mm	H mm	KG	RAL	€
FBG08S070600108	760	600	35	250	7035	43,50
FBG08S070600104	760	600	35	250	5012	43,50
FBG08S120600108	1260	600	35	250	7035	57,30
FBG08S120600104	1260	600	35	250	5012	57,30
FBG08S170600108	1760	600	35	200	7035	72,90
FBG08S170600104	1760	600	35	200	5012	72,90





### Semipiano non fessurato aggiuntivo

ART.	L mm	P mm	H mm	KG	RAL	€
FBG09S070300108	760	300	35	100	7035	29,40
FBG09S070300104	760	300	35	100	5012	29,40
FBG09S120300108	1260	300	35	100	7035	37,20
FBG09S120300104	1260	300	35	100	5012	37,20
FBG09S170300108	1760	300	35	100	7035	46,50
FBG09S170300104	1760	300	35	100	5012	46,50



### Supporto solo per semipiano aggiuntivo

ART.	L mm	P mm	H mm	RAL	€
FBG13S605V00008	605	77	35	7035	9,30
FBG13S605V00004	605	77	35	5012	9,30

ART.	L mm	P mm	H mm	KG	RAL	€
WORK2014	2007	704	737/1112	1000	7035+7016	1052,70



### Composto da:

qtà	descrizione
1	Banco smontato regolabile con piano in acciaio 3 mm
1	Armadio L=500 mm con 4 cassetti H=105 mm
1	Armadio L=500 mm con 1 porta e 1 piano regolabile
1	Chiusura posteriore
1	Semipiano non fessurato L=760 mm
1	Fondo di chiusura per armadio L=500 mm
2	Pannello forato laterale



RAL 7035



RAL 5012



RAL 7035 + RAL 7016



PORTATA

## L= 500 MM 27X27 EH



ART.	adatto per cassetto H mm	n. divisori trasversali	€
FBG18S50DV00199	105/150	3	12,30



ART.	adatto per cassetto H mm	n. divisori trasversali	n. divisori longitudinali	€
FBG18S50DV00299	105/150	1	1	8,70



ART.	adatto per cassetto H mm	componenti	€
FBG18S50CD00103	105/150	4 x Cassetta divisorio 100x50 mm	7,20



ART.	adatto per cassetto H mm	componenti	€
FBG18S50CD00203	105/150	3 x Cassetta divisorio 100x50 mm 2 x Cassetta divisorio 150x75 mm 1 x Cassetta divisorio 150x150 mm	11,10



ART.	adatto per cassetto H mm	componenti	€
MATSEP001	105/150	1 x FBG18S50CD00103 1 x FBG18S50CD00203 1 x FBG18S50DV00299	27,00



ART.	adatto per cassetto H mm	componenti	€
MATSEP002	105/150	1 x FBG18S50CD00103 2 x FBG18S50CD00203 1 x FBG18S50DV00299	38,10



### Tappeto per cassetiera L=500 mm

ART.	materiale	€
FBG18S50TP00107	Poliestere	4,50

**L= 629 MM      36X27 EH**



ART.	adatto per cassetto H mm	n. divisori trasversali	€
<b>FBG18S63DV00199</b>	105/150	3	13,20



ART.	adatto per cassetto H mm	n. divisori trasversali	n. divisori longitudinali	€
<b>FBG18S63DV00299</b>	105/150	1	1	9,30



ART.	adatto per cassetto H mm	componenti	€
<b>FBG18S63CD00103</b>	105/150	5 x Cassetta divisorio 100x50 mm	9,00



ART.	adatto per cassetto H mm	componenti	€
<b>FBG18S63CD00203</b>	105/150	2 x Cassetta divisorio 75x75 mm 2 x Cassetta divisorio 150x75 mm 2 x Cassetta divisorio 150x150 mm	11,10



ART.	adatto per cassetto H mm	componenti	€
<b>MATSEP003</b>	105/150	1 x FBG18S63CD00103 1 x FBG18S63CD00203 1 x FBG18S63DV00299	29,40



ART.	adatto per cassetto H mm	componenti	€
<b>MATSEP004</b>	105/150	1 x FBG18S63CD00103 2 x FBG18S63CD00203 1 x FBG18S63DV00299	40,50



**Tappeto per cassetiera L=629 mm**

ART.	materiale	€
<b>FBG18S63TP00107</b>	Poliestere	5,40

## Configurazioni alternative



Utensili esclusi



ART.	L mm	P mm	H mm	KG	RAL	€
<b>WORK2042</b>	2260	704	2098	1000	7035+7016	1926,30

Composto da:

qtà	descrizione
1	Banco smontato con piano in acciaio 3 mm
2	Armadio L=629 mm con 1 cassetto H=150 mm e 1 porta
1	Armadio L=500 mm con 1 cassetto H=150 mm e 1 porta
2	Pannello forato laterale
1	Cestino capacità 30 L
1	Kit 3 montanti biasolati
1	Kit 3 supporti inclinati con 2 binari
2	Kit 3 pannelli forati/mensole con 2 bordi fermacasse
1	Lampada doppia

qtà	descrizione
7	Gancio Unipok per utensili - confezione 30 pezzi
1	Kit porta rotolo con carta Ø=240 mm
2	Porta bombole inclinato a 2 posti
1	Mensola grande reversibile
1	Supporto multipresa a 4 scomparti
1	Multipresa schuko a 4 scomparti
1	Cavo di collegamento wieland schuko/francese
2	Barra aggancio con 4 contenitori Picking Box misura 1

## Configurazioni alternative



Utensili esclusi



ART.	L mm	P mm	H mm	KG	RAL	€
<b>WORK1540</b>	2052	750	1977/2352	1000	7035+7016	1729,80

Composto da:

qtà	descrizione	qtà	descrizione
1	Banco smontato regolabile con piano in multiplex 30 mm	1	Kit 3 pannelli forati/mensole con 2 bordi fermacasse
1	Armadio L=629 mm con 1 porta e 1 piano regolabile	1	Lampada doppia
1	Fondo di chiusura per armadio L=629 mm	1	Lampada singola
1	Armadio L=629 mm con 3 cassetti H=150 mm	1	Kit porta rotolo con carta Ø=130 mm
2	Pannello forato laterale	1	Supporto multipresa a 4 scomparti
1	Cestino capacità 30 L	1	Multipresa schuko a 4 scomparti
1	Mensola grande reversibile	1	Cavo di collegamento wieland schuko/francese
2	Porta bombolette inclinato a 2 posti	4	Gancio Unipok per utensili - confezione 30 pezzi
1	Kit 2 montanti biasolati	2	Barra aggancio con 4 contenitori Picking Box misura 1
1	Kit 2 supporti inclinati con binario		



RAL 7035 + RAL 7016



PORTATA

# DYNAMIC

## BANCHI DA LAVORO



- |                   |                        |
|-------------------|------------------------|
| 1. Tampono        | 7. Piano in laminato   |
| 2. USB Dati       | 8. Angolare            |
| 3. Telaio         | 9. Supporto            |
| 4. Magnetotermico | 10. Armadio a cassette |
| 5. Multiprese     | 11. Tastierino         |
| 6. USB Ricarica   |                        |



**Portata banco 400 kg**

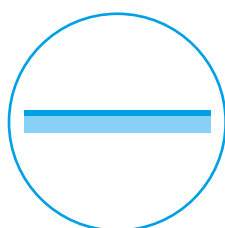

**Piano in laminato**

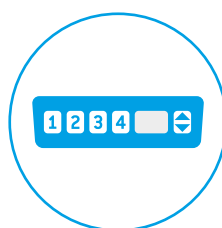

**Tastierino con 3  
memorie**

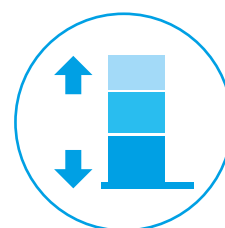

**Regolabile in altezza  
elettronicamente**



# DYNAMIC



ART.	L mm	P mm	H mm	KG	RAL	€
<b>DYNAMIC1504</b>	1497	780	740/1140	400	7035+7016	2593,20

Composto da:

qtà	descrizione	qtà	descrizione
1	Banco smontato regolabile elettricamente	1	Multipresa schuko a 4 scomparti
1	Armadio L=560 mm con 3 cassetti 1x75 2x100	1	Magnetotermico differenziale
1	Telaio portaprese aggiuntivo completo di tamponi e angolari	1	Cavo di collegamento wieland con spine in/out
1	Coppia supporti per armadio	1	Cavo di collegamento wieland schuko/francese
2	Multipresa schuko a 2 scomparti	1	Presse usb dati
		1	Presse usb ricarica



RAL 7035 + RAL 7016



PORTATA



ART.	L mm	P mm	H mm	KG	RAL	€
<b>DYNAMIC1501</b>	1497	780	1983/2383	400	7035+7016	3456,60

Composto da:

qtà	descrizione	qtà	descrizione
1	Banco smontato regolabile elettricamente	2	Lampada singola
1	Armadio L=560 mm con 3 cassetti 1x75 2x100	1	Binario supplementare con attacchi
2	Pannello forato/mensola con 1 bordo fermacasse	1	Presse usb ricarica
1	Kit 2 montanti biasolati	1	Presse usb dati
1	Kit 2 supporti inclinati con binario	1	Cavo di collegamento wieland schuko/francese
1	Pannello forato electric	1	Magnetotermico differenziale
1	Lampada doppia	1	Multiprese schuko a 4 scomparti
1	Coppia supporti per armadio	2	Multiprese schuko a 2 scomparti
1	Telaio portaprese aggiuntivo completo di tamponi e angolari	36	Contenitore in polipropilene Picking Box misura 2

# DYNAMIC



ART.	Lmm	Pmm	Hmm	KG	RAL	€
<b>DYNAMIC1503</b>	1497	780	1983/2383	400	7035+7016	3351,30

Composto da:

qtà	descrizione
1	Banco smontato regolabile elettricamente
1	Armadio L=500 mm con 1 cassetto H=150 mm
1	Binario supplementare con attacchi
1	Pannello forato/mensola
2	Pannello forato/mensola con 1 bordo fermacasse
1	Kit 2 montanti biasolati
1	Kit 2 supporti inclinati con binario
1	Mensola porta oggetti reversibile
1	Gancio Unipok per utensili - confezione 30 pezzi
1	Coperchio per armadio L=500 mm
2	Multipresa schuko a 2 scomparti
1	Multipresa schuko a 4 scomparti
1	Magnetotermico differenziale
1	Cavo di collegamento wieland schuko/francese
1	Presse usb dati
1	Presse usb ricarica
1	Pannello forato electric
1	Lampada doppia
3	Lampada singola
1	Telaio portaprese aggiuntivo completo di tamponi e angolari
1	Coppia supporti per armadio
36	Contenitore in polipropilene Picking Box misura 2

ART.	Lmm	Pmm	Hmm	KG	RAL	€
<b>DYNAMIC1502</b>	1497	780	1983/2383	400	7035+7016	3042,60

Composto da:

qtà	descrizione
1	Banco smontato regolabile elettricamente
2	Pensile con porta
1	Binario supplementare con attacchi
2	Pannello forato/mensola con 1 bordo fermacasse
1	Kit 2 montanti biasolati
1	Kit 2 supporti inclinati con binario
1	Pannello forato electric
1	Multipresa schuko a 4 scomparti
1	Magnetotermico differenziale
1	Cavo di collegamento wieland schuko/francese
1	Presse usb dati
1	Presse usb ricarica
1	Mensola porta oggetti reversibile
1	Lampada doppia
1	Lampada singola
1	Telaio portaprese aggiuntivo completo di tamponi e angolari
2	Multipresa schuko a 2 scomparti
18	Contenitore in polipropilene Picking Box misura 2



RAL 7035 + RAL 7016

PORTATA

**400 kg**



**regolabili in altezza**

**Forniti smontati**



### Banco base con traverso reversibile

ART.	L mm	P mm	H mm	RAL	€
FLE0970E0PD	985	700	740/1140	7035+7016	1443,60
FLE1470E0PD	1470	700	740/1140	7035+7016	1543,20

## 1. Traverso reversibile



Il banco è dotato di gambe regolabili in altezza elettronicamente. L'altezza può variare da un minimo di 740 mm a un massimo di 1140 mm.



Il tastierino numerico consente di controllare il meccanismo di regolazione del banco. Oltre a consentire di modificare l'altezza del piano di lavoro, è dotato anche di 3 memorie di posizionamento per modificare rapidamente l'altezza del banco in base all'utilizzatore.

### vista anteriore del traverso



### vista posteriore del traverso



Il traverso del banco presenta delle incisioni per la collocazione delle prese elettriche e degli interruttori magnetotermici Iron Team Electric. In base alla dimensione scelta, il numero di intagli varia. I diversi componenti possono essere installati sia nella parte posteriore che anteriore del traverso. Gli Iron Team Electric non sono compresi con il traverso.

### schema prese traverso



- 1
- 2
- 3
- 5
- 1



- 1
- 2
- 3
- 4
- 5
- 1

- 1 foro per cavi
- 2 magnetotermico
- 3 multipresa 2 scomparti
- 4 multipresa 4 scomparti
- 5 centralina



1. Traverso reversibile
2. Telaio
3. Angolari
4. Tamponi

**Telaio portaprese aggiuntivo completo di tamponi e angolari**

ART.	L mm	P mm	H mm	RAL	€
FBL46600008	1014	130	208	7035	61,80
FBL46650008	1499	130	208	7035	68,10



Per il montaggio del montante Work Look è necessaria l'installazione del telaio aggiuntivo.

**vista superiore del telaio**



**vista inferiore del telaio**



Il telaio reversibile per banco presenta delle incisioni per la collocazione delle prese elettriche e degli interruttori magnetotermici Iron Team Electric. In base alla dimensione scelta, il numero di intagli varia. I diversi componenti possono essere installati sia nella parte superiore che inferiore del telaio reversibile. Gli Iron Team Electric non sono compresi con il telaio aggiuntivo.

**schema prese telaio**



- 1
- 2
- 4
- 3
- 3
- 5



- 1
- 2
- 4
- 3
- 3
- 5

- 1 USB dati      2 magnetotermico      3 multipresa 2 scomparti      4 multipresa 4 scomparti      5 USB ricarica



Armadio con 3 cassetti



ART.	L mm	P mm	H mm	cassetti				RAL	€	
				n.	h 75 mm	h 100 mm	KG			
MBR05SC010203PD	560	610	369	3	1	2	100-75-50	92-96-100%	7035+7016	450,30

Armadio con 1 cassetto



ART.	L mm	P mm	H mm	cassetti			RAL	€	
				n.	KG	h mm			
FBG03S50C0001PD	500	630	210	1	80	86%	150	7035+7016	100,50



Coperchio per armadio L=500 mm

Per armadio ad 1 cassetto

ART.	L mm	P mm	H mm	RAL	€
FBL66900008	496	601	2	7035	27,90



Coppia supporti per armadio

ART.	L mm	P mm	H mm	RAL	€
FBL46010008	2	648	181	7035	21,90

**IRON TEAM** Electric



FBLET012007



FBLET004007



FBLET005007



FBLET016007



FBLET013007



FBLET020007



FBLET019007

vedi pag. 96





Il banco regolabile in altezza elettronicamente Dynamic consente di creare una postazione di lavoro dinamica ed ergonomica, adatta all'impiego in numerosi settori. Per massimizzare il comfort dell'utilizzatore Dynamic offre numerose soluzioni: armadi con cassetti, telai aggiuntivi o traversi per componenti elettrici, pareti forate Work Look. Le gambe regolabili in altezza sono controllate da un pratico tastierino numerico. L'altezza del banco può essere regolata al millimetro da un minimo di 740 mm ad un massimo di 1140 mm. Consente di memorizzare tre altezze diverse per regolare in velocità e semplicità il piano di lavoro in poche mosse.



- 1. Tappeto ESD a 2 strati
- 2. Spina schuko ESD
- 3. Cinturino regolabile con bottoni completo di cavetto
- 4. Cavetto con bottoni

**Tappeto ESD a 2 strati**

ART.	L mm	P mm	H mm	€
FAXTAPPIER120XB	900	600	2	102,00

**Spina schuko ESD**

ART.	L mm	P mm	H mm	€
FAXSCHUKOESD005	52	52	72	23,40

**Cinturino regolabile con bottoni completo di cavetto**

ART.	L cavo m	€
FAXITE780419304	2,5	8,10

**Cavetto con bottoni**

ART.	L mm	€
FAXITE7804885XB	2500	6,30



RAL 7035



RAL 7035 + RAL 7016



ESTRAZIONE



PORTATA



# WORK LOOK

## PARETI ATTREZZATE

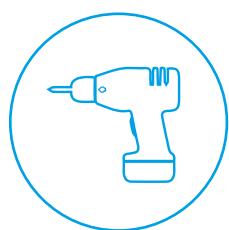
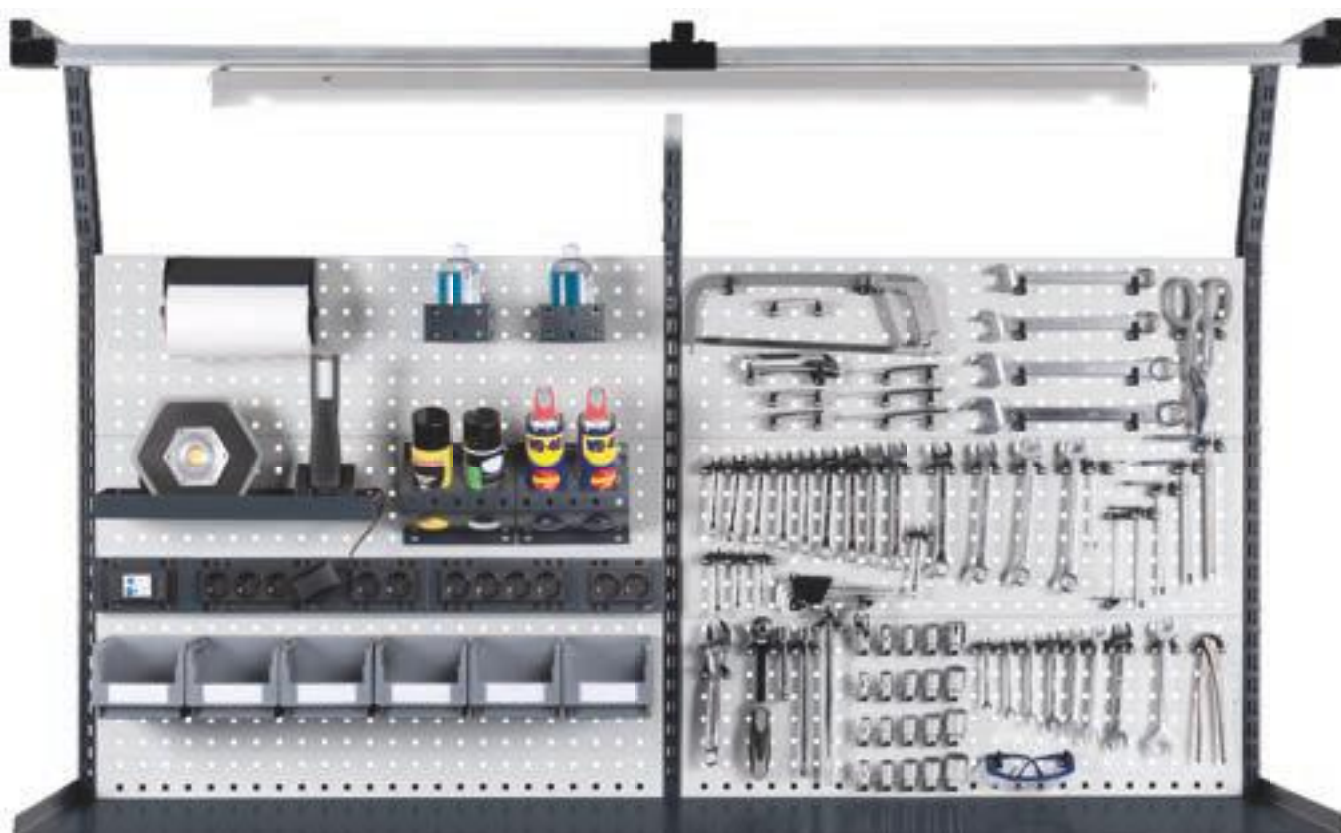

**Fissaggio a muro**

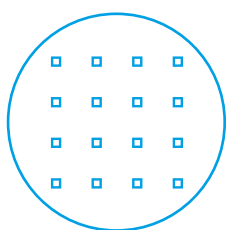

**Fori quadri  
10x10**

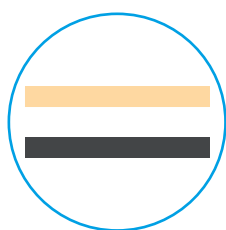

**Adatte per piani  
in legno e acciaio**

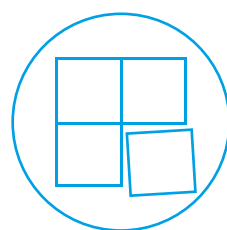

**Modulari**

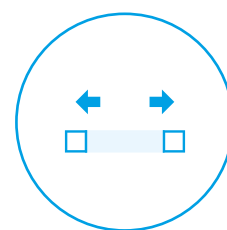

**Passo 38 mm**

# WORK LOOK



ART.	L mm	P mm	H mm	KG	RAL	€
MASTERBR1507	1706	750	1985/2360	1000	7035+7016	2289,90

Composto da:

qtà	descrizione
1	Banco smontato con piano in multiplex 40 mm
1	Armadio L=560 mm con 5 cassetti 1x75 3x100 1x200
2	Piano superiore/inferiore L=560 mm
1	Porta totale sinistra H=600 mm con maniglia Dark Grey
1	Piano interno L=558 mm
1	Supporto semipiano intermedio
2	Pannello forato laterale
1	Barra led
1	Coppia staffe di fissaggio pensile su montanti
1	Pensile vasistas senza serratura
1	Lampada doppia
1	Kit 2 pannelli forati/mensole con 1 bordo fermacasse
1	Kit 2 supporti inclinati con binario

qtà	descrizione
1	Kit 2 montanti biasolati
1	Cestino capacità 30 L
1	Mensola grande reversibile
1	Barra aggancio con 4 contenitori Picking Box misura 1
3	Gancio Unipok per utensili - confezione 30 pezzi
2	Porta bombolette inclinato a 2 posti
1	Kit porta rotolo con carta Ø=130 mm
1	Tasca porta documenti A4
1	Cavo di collegamento wieland schuko/francese
1	Multipresa schuko a 4 scomparti
1	Multipresa schuko a 2 scomparti
1	Supporto multipresa a 4 scomparti
1	Supporto multipresa a 2 scomparti
1	Kit 2 contenitori Picking Box misura 3A2



PORTATA



RAL 7035 + RAL 7016

# WORK LOOK



Cambia l'aspetto del tuo banco da lavoro per adattarlo a diversi utilizzi con Work Look!

In base a come lo installi lo puoi utilizzare come:

**pannello forato, mensola orizzontale, mensola inclinata con bordo fermacasse.**



ART.	L mm	P mm	H mm	KG montanti	RAL	€
WORKLOOK1001	1015	80	639	50	7035+7016	120,00
WORKLOOK1002	1015	80	639	50	5012	120,00

Composto da:

qtà	descrizione
1	Kit 2 montanti biasolati
1	Kit 2 pannelli forati/mensole con 1 bordo fermacasse



ART.	L mm	P mm	H mm	KG montanti	RAL	€
WORKLOOK1003	1015	80	943	50	7035+7016	170,10
WORKLOOK1004	1015	80	943	50	5012	170,10

Composto da:

qtà	descrizione
1	Kit 2 montanti biasolati
1	Kit 3 pannelli forati/mensole con 2 bordi fermacasse



ART.	L mm	P mm	H mm	KG montanti	RAL	€
WORKLOOK1501	1500	80	639	50	7035+7016	147,00
WORKLOOK1502	1500	80	639	50	5012	147,00

Composto da:

qtà	descrizione
1	Kit 2 montanti biasolati
1	Kit 2 pannelli forati/mensole con 1 bordo fermacasse



ART.	L mm	P mm	H mm	KG montanti	RAL	€
WORKLOOK1503	1500	80	943	50	7035+7016	211,20
WORKLOOK1504	1500	80	943	50	5012	211,20

Composto da:

qtà	descrizione
1	Kit 2 montanti biasolati
1	Kit 3 pannelli forati/mensole con 2 bordi fermacasse

# WORK LOOK



ART.	L mm	P mm	H mm	 montanti	RAL	€
<b>WORKLOOK2001</b>	2000	80	639	50	7035+7016	221,40
<b>WORKLOOK2002</b>	2000	80	639	50	5012	221,40

Composto da:

qtà	descrizione
1	Kit 3 montanti biasolati
2	Kit 2 pannelli forati/mensole con 1 bordo fermacasse



ART.	L mm	P mm	H mm	 montanti	RAL	€
<b>WORKLOOK2003</b>	2000	80	943	50	7035+7016	315,00
<b>WORKLOOK2004</b>	2000	80	943	50	5012	315,00

Composto da:

qtà	descrizione
1	Kit 3 montanti biasolati
2	Kit 3 pannelli forati/mensole con 2 bordi fermacasse



ART.	L mm	P mm	H mm	 montanti	RAL	€
<b>WORKLOOK3001</b>	2970	80	639	50	7035+7016	275,40
<b>WORKLOOK3002</b>	2970	80	639	50	5012	275,40

Composto da:

qtà	descrizione
1	Kit 3 montanti biasolati
2	Kit 2 pannelli forati/mensole con 1 bordo fermacasse



ART.	L mm	P mm	H mm	 montanti	RAL	€
<b>WORKLOOK3003</b>	2970	80	943	50	7035+7016	397,20
<b>WORKLOOK3004</b>	2970	80	943	50	5012	397,20

Composto da:

qtà	descrizione
1	Kit 3 montanti biasolati
2	Kit 3 pannelli forati/mensole con 2 bordi fermacasse

## Esempi di configurazione



PORTATA



RAL 7035 + RAL 7016



RAL 5012

# WORKLOOK



ART.	L mm	P mm	H mm	KG montanti	RAL	€
<b>WORKLOOK1005</b>	1015	373	1063	50	7035+7016	452,10
<b>WORKLOOK1006</b>	1015	373	1063	50	5012	452,10

Composto da:

qtà	descrizione
1	Kit 2 montanti biasolati
1	Kit 2 pannelli forati/mensole con 1 bordo fermacasse
1	Pensile vasistas senza serratura
1	Coppia staffe di fissaggio pensile su montanti



ART.	L mm	P mm	H mm	KG montanti	RAL	€
<b>WORKLOOK1007</b>	1015	373	1063	50	7035+7016	513,60
<b>WORKLOOK1008</b>	1015	373	1063	50	5012	513,60

Composto da:

qtà	descrizione
1	Kit 2 montanti biasolati
1	Pannello forato/mensola con 1 bordo fermacasse
1	Pannello forato electric
1	Pensile vasistas senza serratura
1	Coppia staffe di fissaggio pensile su montanti
1	Multipresa schuko a 4 scomparti
1	Cavo di collegamento wieland schuko/francese



ART.	L mm	P mm	H mm	KG montanti	RAL	€
<b>WORKLOOK1505</b>	1500	373	1063	50	7035+7016	506,70
<b>WORKLOOK1506</b>	1500	373	1063	50	5012	506,70

Composto da:

qtà	descrizione
1	Kit 2 montanti biasolati
1	Kit 2 pannelli forati/mensole con 1 bordo fermacasse
1	Pensile vasistas senza serratura
1	Coppia staffe di fissaggio pensile su montanti



ART.	L mm	P mm	H mm	KG montanti	RAL	€
<b>WORKLOOK1507</b>	1500	373	1063	50	7035+7016	571,80
<b>WORKLOOK1508</b>	1500	373	1063	50	5012	571,80

Composto da:

qtà	descrizione
1	Kit 2 montanti biasolati
1	Pannello forato/mensola con 1 bordo fermacasse
1	Pannello forato electric
1	Pensile vasistas senza serratura
1	Coppia staffe di fissaggio pensile su montanti
1	Multipresa schuko a 4 scomparti
1	Cavo di collegamento wieland schuko/francese



# WORK LOOK



ART.	L mm	P mm	H mm	KG montanti	RAL	€
<b>WORKLOOK2005</b>	2000	373	1063	50	7035+7016	879,00
<b>WORKLOOK2006</b>	2000	373	1063	50	5012	879,00

Composto da:

qtà	descrizione
1	Kit 3 montanti biasolati
2	Kit 2 pannelli forati/mensole con 1 bordo fermacasse
2	Pensile vasistas senza serratura
2	Coppia staffe di fissaggio pensile su montanti



ART.	L mm	P mm	H mm	KG montanti	RAL	€
<b>WORKLOOK2007</b>	2000	373	1063	50	7035+7016	1004,10
<b>WORKLOOK2008</b>	2000	373	1063	50	5012	1004,10

Composto da:

qtà	descrizione
1	Kit 3 montanti biasolati
2	Pannello forato/mensola con 1 bordo fermacasse
2	Pannello forato electric
2	Pensile vasistas senza serratura
2	Coppia staffe di fissaggio pensile su montanti
2	Multipresa schuko a 4 scomparti
1	Cavo di collegamento wieland con spine in/out
1	Cavo di collegamento wieland schuko/francese



ART.	L mm	P mm	H mm	KG montanti	RAL	€
<b>WORKLOOK3005</b>	2970	373	1063	50	7035+7016	988,20
<b>WORKLOOK3006</b>	2970	373	1063	50	5012	988,20

Composto da:

qtà	descrizione
1	Kit 3 montanti biasolati
2	Kit 2 pannelli forati/mensole con 1 bordo fermacasse
2	Pensile vasistas senza serratura
2	Coppia staffe di fissaggio pensile su montanti



ART.	L mm	P mm	H mm	KG montanti	RAL	€
<b>WORKLOOK3007</b>	2970	373	1063	50	7035+7016	1120,50
<b>WORKLOOK3008</b>	2970	373	1063	50	5012	1120,50

Composto da:

qtà	descrizione
1	Kit 3 montanti biasolati
2	Pannello forato/mensola con 1 bordo fermacasse
2	Pannello forato electric
2	Pensile vasistas senza serratura
2	Coppia staffe di fissaggio pensile su montanti
2	Multipresa schuko a 4 scomparti
1	Cavo di collegamento wieland con spine in/out
1	Cavo di collegamento wieland schuko/francese



## Esempi di configurazione



PORTATA



RAL 7035 + RAL 7016



RAL 5012





### Kit 2 montanti biasolati

ART.	L mm	P mm	H mm	KG	adatto per banco L mm	RAL	€
FBL75301604	30	80	639	50	1000-1500	5012	38,70
FBL75301639	30	80	639	50	1000-1500	7016	38,70
FBL75351604	30	80	943	50	1000-1500	5012	47,40
FBL75351639	30	80	943	50	1000-1500	7016	47,40

### Kit 3 montanti biasolati

ART.	L mm	P mm	H mm	KG	adatto per banco L mm	RAL	€
FBL75302104	30	80	639	50	2000-3000	5012	58,80
FBL75302139	30	80	639	50	2000-3000	7016	58,80
FBL75352104	30	80	943	50	2000-3000	5012	69,60
FBL75352139	30	80	943	50	2000-3000	7016	69,60



# WORK LOOK

## Supporti inclinati con binario base



### Kit 2 supporti inclinati con binario

ART.	L mm	P mm	H mm	RAL	€
FBL98102039	1015	686	307	7016	86,70
FBL98102004	1015	686	307	5012	79,20



### Kit 2 supporti inclinati con binario

ART.	L mm	P mm	H mm	RAL	€
FBL98152039	1500	686	307	7016	89,70
FBL98152004	1500	686	307	5012	82,50



### Kit 3 supporti inclinati con 2 binari

ART.	L mm	P mm	H mm	RAL	€
FBL98202039	2000	686	307	7016	136,20
FBL98202004	2000	686	307	5012	124,50



### Kit 3 supporti inclinati con 2 binari

ART.	L mm	P mm	H mm	RAL	€
FBL98302039	2970	686	307	7016	142,20
FBL98302004	2970	686	307	5012	132,00



### Binario supplementare con attacchi

ART.	L mm	P mm	H mm	materiale	€
FBL98101000	1015	60	67	Alluminio	36,00
FBL98151000	1500	60	67	Alluminio	40,80

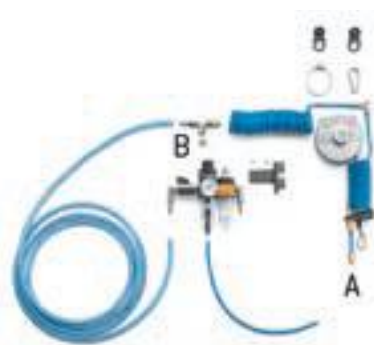

### Set aria compressa con bilanciatore e filtro

ART.	€
FBL97200300	455,40

Completo di:

- 1 cavo flessibile Ø 10 mm
- 1 connettore a T da 1/4" con tappo (B)
- 2 attacchi di scorrimento
- 1 moschettone
- 1 bilanciatore con cavo in acciaio lunghezza 1600 mm portata 1/2 kg
- 1 attacco universale 1/4" per utensili (A)
- 1 tubo a spirale diametro interno 5,5 mm
- 1 tubo diametro interno 5,5 mm per lo spurgo del filtro
- 1 gruppo filtro regolatore con manometro - il quale può essere utilizzato con una pressione massima di 10 bar, la sua capacità è di circa 9 litri al secondo (sul punto A) e di 11 litri al secondo (sul punto B) con una pressione di utilizzo pari a 6,3 bar (la capacità può variare a seconda delle caratteristiche tecniche della rete pneumatica a cui l'impianto Fami viene allacciato)
- raccordi da 1/4"



PORTATA



RAL 7016



RAL 5012

# WORK LOOK

## Pannelli forati/mensola 953 mm



### Pannello forato/mensola

ART.	L mm	P mm	H mm	Dim. foro mm	Passo mm	RAL	€
FBL76160008	953	31	304	10x10	38	7035	36,30
FBL76160004	953	31	304	10x10	38	5012	36,30



### Kit 2 pannelli forati/mensole con 1 bordo fermacasse

ART.	L mm	P mm	H mm	Dim. foro mm	Passo mm	RAL	€
FBL76160208	953	60	304	10x10	38	7035	81,30
FBL76160204	953	60	304	10x10	38	5012	81,30



### Kit 3 pannelli forati/mensole con 2 bordi fermacasse

ART.	L mm	P mm	H mm	Dim. foro mm	Passo mm	RAL	€
FBL76160308	953	60	304	10x10	38	7035	122,70
FBL76160304	953	60	304	10x10	38	5012	122,70



### Pannello forato/mensola con 1 bordo fermacasse

ART.	L mm	P mm	H mm	Dim. foro mm	Passo mm	RAL	€
FBL76170108	953	60	456	10x10	38	7035	61,20
FBL76170104	953	60	456	10x10	38	5012	61,20



### Pannello forato electric

ART.	L mm	P mm	H mm	Dim. foro mm	Passo mm	RAL	€
FBL76180008	953	31	152	10x10	38	7035	38,10
FBL76180004	953	31	152	10x10	38	5012	38,10



1. USB Dati
2. Magnetotermico differenziale
3. Multipresa 4 scomparti
4. Multipresa 2 scomparti
5. USB Ricarica

# WORK LOOK

## Pannelli forati/mensola 1438 mm



### Pannello forato/mensola

ART.	L mm	P mm	H mm	Dim. foro mm	Passo mm	RAL	€
FBL76310008	1438	31	304	10x10	38	7035	50,40
FBL76310004	1438	31	304	10x10	38	5012	50,40



### Kit 2 pannelli forati/mensole con 1 bordo fermacasse

ART.	L mm	P mm	H mm	Dim. foro mm	Passo mm	RAL	€
FBL76310208	1438	60	304	10x10	38	7035	108,30
FBL76310204	1438	60	304	10x10	38	5012	108,30



### Kit 3 pannelli forati/mensole con 2 bordi fermacasse

ART.	L mm	P mm	H mm	Dim. foro mm	Passo mm	RAL	€
FBL76310308	1438	60	304	10x10	38	7035	163,80
FBL76310304	1438	60	304	10x10	38	5012	163,80



### Pannello forato/mensola con 1 bordo fermacasse

ART.	L mm	P mm	H mm	Dim. foro mm	Passo mm	RAL	€
FBL76320108	1438	60	456	10x10	38	7035	81,00
FBL76320104	1438	60	456	10x10	38	5012	81,00



### Pannello forato electric

ART.	L mm	P mm	H mm	Dim. foro mm	Passo mm	RAL	€
FBL76330008	1438	31	152	10x10	38	7035	48,90
FBL76330004	1438	31	152	10x10	38	5012	48,90



### Coppia supporti per pannello forato/mensola

ART.	L mm	P mm	H mm	RAL	€
FVT01010039	12	237	99	7016	14,10



RAL 7016



RAL 7035



RAL 5012

# WORK LOOK



ART.	RAL	€
WORKLOOK9001	7035	1179,90



Composto da:

qtà	descrizione
2	Pannello forato/mensola con 1 bordo fermacasse
3	Pannello forato/mensola
5	Kit staffe per fissaggio pannelli a parete
1	Mensola porta oggetti reversibile
1	Porta flacone igienizzante reversibile
1	Kit porta rotolo con carta Ø=240 mm
1	Dispenser per guanti
1	Tasca porta documenti A4
2	Mensola grande reversibile

qtà	descrizione
1	Cestino capacità 30 L
5	Gancio Unipok per utensili - confezione 30 pezzi
1	Multipresa schuko a 2 scomparti
1	Multipresa schuko a 4 scomparti
1	Magnetotermico differenziale
1	Cavo di collegamento wieland schuko/francese
1	Supporto multipresa a 2 scomparti
1	Supporto multipresa a 4 scomparti
1	Supporto per magnetotermico differenziale
2	Lampada doppia

## Kit staffe per fissaggio pannelli a parete

ART.	finitura	€
FBL76000099	Zincato	6,30





# WORK LOOK



Pannelli forati vedi pag. 60  
Fissaggio a muro dei pannelli forati vedi pag. 62  
Ganci Unipok vedi pag. 85  
Ganci The Block vedi pag. 86  
Accessori Iron Team vedi pag. 90

  
RAL 7035

  
RAL 5012

# WORK LOOK

## Tapparelle



### Armadio con tapparella

ART.	L mm	P mm	H mm	RAL	€
FBL8050C00008	943	220	912	7035	487,20
FBL8050C00004	943	220	912	5012	487,20
FBL8054C00008	1428	220	912	7035	665,40
FBL8054C00004	1428	220	912	5012	665,40
FBL8056C00008	1928	220	912	7035	727,80
FBL8056C00004	1928	220	912	5012	727,80

### Coppia staffe di fissaggio armadio con tapparella su montanti

ART.	L mm	P mm	H mm	RAL	€
FBL8060000008	33	21	904	7035	27,00
FBL8060000004	33	21	904	5012	27,00

 Da utilizzare per il fissaggio dell'armadio con tapparella ai montanti biasolati



### Barra led

Senza pulsante on/off

ART.	L mm	temperatura colore K	Watt	Hz	Lumen	€
FBL99400213	873	4000	15	50/60	1500	45,90
FBL99450213	1173	4000	20	50/60	2000	47,10

# WORK LOOK

## Pensili



### Pensile vasistas senza serratura

ART.	L mm	P mm	H mm	KG	RAL	€
FBL8005X000PD	943	350	456	50	7035+7016	300,00
FBL8005X00004	943	350	456	50	5012	300,00
FBL8010X000PD	1428	350	456	50	7035+7016	327,60
FBL8010X00004	1428	350	456	50	5012	327,60



### Set di chiusura per pensile

ART.	€
FBL8020C00000	11,40



### Coppia staffe di fissaggio pensile su montanti

ART.	L mm	P mm	H mm	RAL	€
FBL8025000008	33	21	455	7035	23,40
FBL8025000004	33	21	455	5012	23,40

⚠ Da utilizzare per il fissaggio del pensile ai montanti biasolati



### Barra led

Senza pulsante on/off

ART.	L mm	temperatura colore K	Watt	Hz	Lumen	€
FBL99350213	573	4000	10	50/60	1000	35,40
FBL99400213	873	4000	15	50/60	1500	45,90
FBL99450213	1173	4000	20	50/60	2000	47,10



PORTATA



RAL 7035 + RAL 7016



RAL 5012



RAL 7035



# COMPONENTS



# COMPONENTS



## Tavolo con gambe pieghevoli

ART.	Dim. ingombro aperto			Dim. ingombro chiuso			materiale piano	KG	RAL	€
	L mm	P mm	H mm	L mm	P mm	H mm				
F22WWTABLE00039	1184	590	896	1100	590	60	Multiplex	400	7016	270,90



## Kit 3 ganci per fissaggio verticale tavolo

ART.	L mm	P mm	H mm	KG	RAL	€
F22WWTABLEFIS39	152	81	92	25	7016	29,70

KG  
PORTATA

RAL 7016

# COMPONENTS

## Sedie da lavoro



Sedia regolabile con pompa a gas con ruote

ART.	L mm	P mm	materiale	H seduta mm	n. ruote	€
FAX1100RG000000	630	630	Faggio	510/690	5	164,40



Sedia regolabile con pompa a gas con piedini

ART.	L mm	P mm	materiale	H seduta mm	n. piedini	colore	€
FAX120000000007	630	630	Poliuretano	580/840	5	Nero	247,20



Sedia regolabile con pompa a gas con ruote

ART.	L mm	P mm	materiale	H seduta mm	n. ruote	colore	€
FAX125000000007	630	630	Poliuretano	540/730	5	Nero	204,30

# COMPONENTS

## Sedie da lavoro



**Sedia regolabile con pompa a gas con ruote**

ART.	L mm	P mm	materiale	H seduta mm	n. ruote	colore	€
FAXCATY50000007	630	630	Poliuretano	435/565	5	Nero	351,90



**Sedia regolabile con pompa a gas con ruote**

ART.	L mm	P mm	materiale	H seduta mm	n. ruote	colore	€
FAXCATY80000007	630	630	Poliuretano	525/710	5	Nero	419,40



**Sedia antistatica regolabile con pompa a gas con ruote**

ART.	L mm	P mm	materiale	H seduta mm	n. ruote	colore	€
FAXGREF21200001	640	640	Tessuto antistatico	470/600	5	Grigio scuro	399,90

# ERGO WORK

## BRACCI ESTENSIBILI

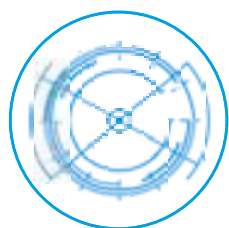

**Configurabile**

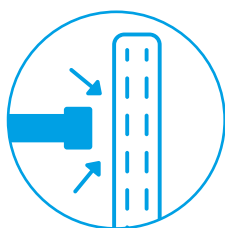

**Fissaggio su  
montante**

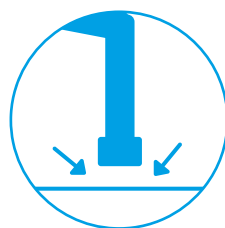

**Fissaggio su  
piano**



**Portata 20 kg**

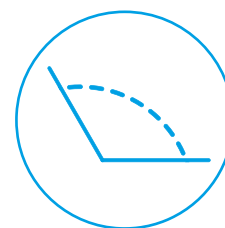

**Angolo rotazione  
240-260°**



# ERGO WORK



ART.	L mm	P mm	H mm	 KG	RAL	€
<b>DYNAMIC1506</b>	1497/3139	780	1983/2383	400	7035+7016	4509,00

Composto da:

qtà	descrizione
1	Banco smontato regolabile elettricamente
1	Armadio L=500 mm con 1 cassetto H=150 mm
1	Coperchio per armadio L=500 mm
1	Coppia supporti per armadio
1	Telaio portaprese aggiuntivo completo di tamponi e angolari
1	Kit 2 montanti biasolati
1	Kit 2 supporti inclinati con binario
1	Lampada doppia
1	Binario supplementare con attacchi
1	Set aria compressa con bilanciatore e filtro
2	Pannello forato/mensola con 1 bordo fermacasse
3	Lampada singola
1	Pannello forato/mensola
1	Pannello forato electric
2	Gancio Unipok per utensili - confezione 30 pezzi
1	Magnetotermico differenziale

qtà	descrizione
1	Multipresa schuko a 4 scomparti
2	Multipresa schuko a 2 scomparti
1	Presse usb ricarica
1	Presse usb dati
1	Cavo di collegamento wieland schuko/francese
1	Dispenser per guanti
1	Porta flacone igienizzante reversibile
36	Contenitore in polipropilene Picking Box misura 2
4	Braccio estensibile per montante
1	Snodo per piastra
3	Piastra porta monitor con standard VESA
1	Pannello per Picking Box
3	Barra aggancio con 4 contenitori Picking Box misura 1
1	Pannello per Visual Box
2	Cassettiera Visual Box con 6 cassette H=112 mm
1	Cassettiera Visual Box con 5 cassette H=164 mm
1	Vassoio inclinato



PORTATA



RAL 7035 + RAL 7016



## Braccio estensibile con Picking Box

ART.	L mm	P mm	H mm	RAL	€
ERGOWORK002	760/515	470/283	356	7016	179,70

Composto da:

qtà	descrizione
1	Braccio estensibile per montante
1	Piastra porta monitor con standard VESA
1	Pannello per Picking Box
3	Barra aggancio con 4 contenitori Picking Box misura 1



## Braccio estensibile con Picking Box

ART.	L mm	P mm	H mm	RAL	€
ERGOWORK003	826/515	470/348	356	7016	173,70

Composto da:

qtà	descrizione
1	Braccio estensibile per montante
1	Piastra porta monitor con standard VESA
1	Pannello per Picking Box
1	Barra aggancio con 3 contenitori Picking Box misura 2
1	Barra aggancio con 4 contenitori Picking Box misura 1



## Braccio estensibile con Visual Box

ART.	L mm	P mm	H mm	RAL	€
ERGOWORK004	738/612	601/294	390	7016	238,50

Composto da:

qtà	descrizione
1	Braccio estensibile per montante
1	Piastra porta monitor con standard VESA
1	Pannello per Visual Box
1	Cassetiera Visual Box con 5 cassette H=164 mm
2	Cassetiera Visual Box con 6 cassette H=112 mm



## Piastra porta monitor con squadrette

ART.	L mm	P mm	H mm	RAL	€
ERGOWORK014	225/129	119/225	225	7016	41,10

Composto da:

qtà	descrizione
1	Coppia squadrette a L
1	Snodo per piastra
1	Piastra porta monitor con standard VESA





## Pannello forato con cerniere

ART.	L mm	P mm	H mm	RAL	€
ERGOWORK007	647	50	479	7035	70,50

Composto da:

qtà	descrizione
1	Pannello forato/mensola con 1 bordo fermacasse
1	Kit cerniere per pannello forato



## Braccio estensibile con vassoio inclinato

ART.	L mm	P mm	H mm	RAL	€
ERGOWORK005	674/522	425/470	194	7016	142,20

Composto da:

qtà	descrizione
1	Braccio estensibile per montante
1	Vassoio inclinato



## Braccio estensibile con piastra porta monitor

ART.	L mm	P mm	H mm	RAL	€
ERGOWORK001	652/330	225/225	225	7016	125,70

Composto da:

qtà	descrizione
1	Braccio estensibile per montante
1	Snodo per piastra
1	Piastra porta monitor con standard VESA





ART.	L mm	P mm	H mm	 senza ruote	 set ruote	RAL	€
<b>CLEVER1031</b>	1036	672	1428	300	300	7035	631,80

Composto da:

qtà	descrizione	qtà	descrizione
1	Carrello smontato senza ruote	1	Profilo con base per piano
1	Piano in legno con supporti	1	Coppia squadrette a L
2	Pannello laterale forato	1	Snodo per piastra
1	Pannello posteriore forato	1	Piastra porta monitor con standard VESA
1	Coppia porte a battente	1	Kit ruote in gomma antitraccia sintetica Ø 125 mm



### Braccio estensibile con vassoio inclinato

ART.	L mm	P mm	H mm	RAL	€
ERGOWORK013	745/521	425/480	552	7016	184,20

Composto da:

qtà	descrizione
1	Profilo con base per piano
1	Braccio estensibile per profilo
1	Vassoio inclinato

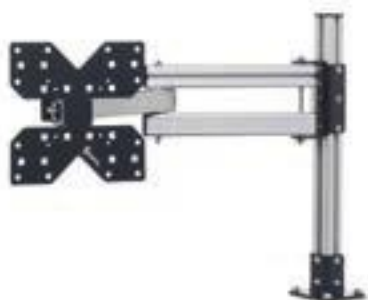

### Braccio estensibile con piastra porta monitor

ART.	L mm	P mm	H mm	RAL	€
ERGOWORK009	724/402	225/192	550	7016	167,70

Composto da:

qtà	descrizione
1	Profilo con base per piano
1	Braccio estensibile per profilo
1	Snodo per piastra
1	Piastra porta monitor con standard VESA



### Profilo con piastra porta monitor

ART.	L mm	P mm	H mm	RAL	€
ERGOWORK008	225/199	151/225	560	7016	80,10

Composto da:

qtà	descrizione
1	Profilo con base per piano
1	Coppia squadrette a L
1	Snodo per piastra
1	Piastra porta monitor con standard VESA



PORTATA



RAL 7016



RAL 7035



### Braccio estensibile con Picking Box

ART.	L mm	P mm	H mm	RAL	€
ERGOWORK010	832/515	470/300	628	7016	221,70

Composto da:

qtà	descrizione
1	Profilo con base per piano
1	Braccio estensibile per profilo
1	Piastra porta monitor con standard VESA
1	Pannello per Picking Box
3	Barra aggancio con 4 contenitori Picking Box misura 1



### Braccio estensibile con Picking Box

ART.	L mm	P mm	H mm	RAL	€
ERGOWORK011	898/515	470/365	628	7016	215,70

Composto da:

qtà	descrizione
1	Profilo con base per piano
1	Braccio estensibile per profilo
1	Piastra porta monitor con standard VESA
1	Pannello per Picking Box
1	Barra aggancio con 3 contenitori Picking Box misura 2
1	Barra aggancio con 4 contenitori Picking Box misura 1



### Braccio estensibile con Visual Box

ART.	L mm	P mm	H mm	RAL	€
ERGOWORK012	808/601	601/275	668	7016	280,50

Composto da:

qtà	descrizione
1	Profilo con base per piano
1	Braccio estensibile per profilo
1	Piastra porta monitor con standard VESA
1	Pannello per Visual Box
1	Cassettiera Visual Box con 5 cassette H=164 mm
2	Cassettiera Visual Box con 6 cassette H=112 mm

# ERGO WORK



ART.	L mm	P mm	H mm	KG	RAL	€
MASTERBR2008	3347	750	1985/2360	1000	7035+7016	2760,30

Composto da:

qtà	descrizione
1	Banco smontato con piano in multiplex 40 mm
1	Copertura per piano in multiplex
1	Armadio L=560 mm con 4 cassetti 1x75 2x150 1x200
1	Armadio L=560 mm predisposto per porta con 1 piano regolabile
1	Porta totale sinistra H=600 mm con maniglia Dark Grey
2	Semipiano aggiuntivo L=560 mm
1	Kit 2 montanti biasolati
1	Kit 2 supporti inclinati con binario
1	Binario supplementare con attacchi
1	Lampada doppia
1	Kit 3 pannelli forati/mensole con 2 bordi fermacasse
1	Pannello forato electric
2	Multipresa schuko a 2 scomparti
1	Multipresa schuko a 4 scomparti

qtà	descrizione
1	Magnetotermico differenziale
1	Cavo di collegamento wieland schuko/francese
1	Porta flacone igienizzante reversibile
1	Dispenser per guanti
1	Kit porta rotolo con carta Ø=240 mm
4	Kit 2 contenitori Picking Box misura 3A2
2	Pannello forato/mensole con 1 bordo fermacasse
2	Kit cerniere per pannello forato
4	Barra aggancio con 4 contenitori Picking Box misura 1
4	Barra aggancio con 3 contenitori Picking Box misura 2
2	Profilo con base per piano
2	Braccio estensibile per profilo
1	Vassoio inclinato
1	Snodo per piastra
1	Piastra porta monitor con standard VESA



PORTATA



RAL 7035 + RAL 7016



RAL 7016



1. Piastra porta monitor con standard VESA
2. Snodo per piastra
3. Braccio estensibile per profilo
4. Profilo con base per piano



1. Piastra porta monitor con standard VESA
2. Pannello per Visual Box
3. Cassetteria Visual Box con 6 cassette H=112 mm
4. Braccio estensibile per montante



### Braccio estensibile per montante

ART.	L mm	P mm	H mm	angolo rotazione °	materiale	KG	RAL	€
FBL74100039	580/330	72/97	158	240	Alluminio	20	7016	98,10



### Braccio estensibile per profilo

Da utilizzare su profilo con base per piano

ART.	L mm	P mm	H mm	angolo rotazione °	materiale	KG	RAL	€
FBL74180039	621/371	57/90	158	260	Alluminio	20	7016	101,10



### Profilo con base per piano

ART.	L mm	P mm	H mm	adatto per	materiale	KG	RAL	€
FBL74160039	100	100	504	Piano in multiplex-Piano in MDF con copertura gommata	Alluminio	20	7016	39,00



### Pannello per Visual Box

Da utilizzare con piastra porta monitor

ART.	L mm	P mm	H mm	Dim. foro mm	Passo mm	KG	RAL	€
FBL74150039	601	31	313	10x10	38	20	7016	54,00

vedi Visual Box pag. 322



**Piastra porta monitor con standard VESA**

Orientabile su un asse

ART.	L mm	P mm	H mm	RAL	€
FBL74120039	225	50	225	7016	13,20



**Snodo per piastra**

Da utilizzare con piastra porta monitor per orientarla su due assi

ART.	L mm	P mm	H mm	RAL	€
FBL74110039	91	67	51	7016	14,40



**Coppia squadrette a L**

Da utilizzare con piastra porta monitor

ART.	L mm	P mm	H mm	RAL	€
FBL74170039	38	36	32	7016	13,50



**Vassoio inclinato**

ART.	L mm	P mm	H mm	RAL	€
FBL74130039	425	308	135	7016	44,10



1. Vassoio inclinato
2. Braccio estensibile per profilo
3. Profilo con base per piano



PORTATA



RAL 7016





**Pannello per Picking Box**

Da utilizzare con piastra porta monitor

ART.	L mm	P mm	H mm	adatto per	 kg	RAL	€
FBL74140039	470	12	356	Contenitore Picking Box mis. 1/2	20	7016	39,60



**Barra aggancio con 4 contenitori Picking Box misura 1**

ART.	L mm	P mm	H mm	colore contenitori	€
FBLIT011000	445	168	85	Grigio scuro	9,60
FBLIT012000	445	168	85	Nero	15,90



**Barra aggancio con 3 contenitori Picking Box misura 2**

ART.	L mm	P mm	H mm	colore contenitori	€
FBLIT013000	447	233	123	Grigio scuro	13,20
FBLIT014000	447	233	123	Nero	21,90

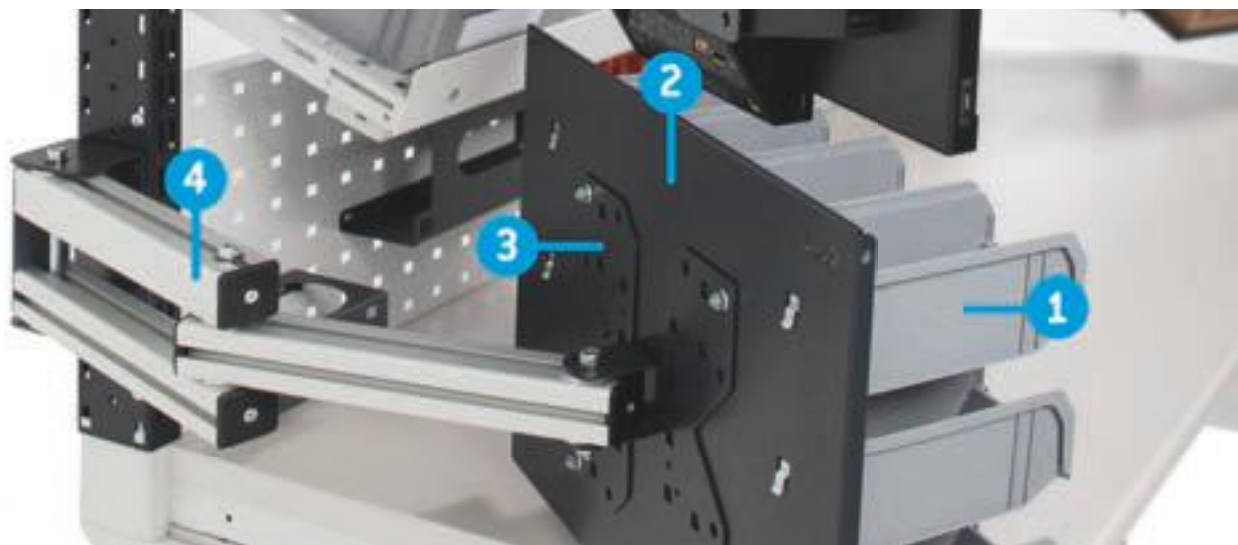

1. Barra aggancio con 4 contenitori Picking Box misura 1
2. Pannello per Picking Box
3. Piastra porta monitor con standard VESA
4. Braccio estensibile per montante



**Pannello forato/mensola**

ART.	L mm	P mm	H mm	Dim. foro mm	Passo mm	RAL	€
FBL76070008	647	31	304	10x10	38	7035	34,80
FBL76070004	647	31	304	10x10	38	5012	34,80



**Pannello forato/mensola con 1 bordo fermacasse**

ART.	L mm	P mm	H mm	Dim. foro mm	Passo mm	RAL	€
FBL76080108	647	60	456	10x10	38	7035	46,20
FBL76080104	647	60	456	10x10	38	5012	46,20



**Kit cerniere per pannello forato**

ART.	L mm	P mm	H mm	€
FBL7600011F	64	54	21	24,30



1. Pannello forato/mensola con 1 bordo fermacasse
2. Kit cerniere per pannello forato



PORTATA



RAL 5012



RAL 7016



RAL 7035



ART.	L mm	P mm	H mm	KG	RAL	€
MASTERBR1509	1706/3016	750	1985/2360	1000	7035+7016	2682,00

Composto da:

qtà	descrizione	qtà	descrizione
1	Banco smontato con piano in multiplex 40 mm	3	Braccio estensibile per montante
1	Armadio L=560 mm con 5 cassetti 1x75 3x100 1x200	1	Snodo per piastra
2	Piano superiore/inferiore L=560 mm	2	Piastra porta monitor con standard VESA
1	Porta totale sinistra H=600 mm con maniglia Dark Grey	1	Vassoio inclinato
1	Piano interno L=558 mm	1	Pannello per Visual Box
1	Supporto semipiano intermedio	1	Cassetiera Visual Box con 5 cassetti H=164 mm
2	Pannello forato laterale	2	Cassetiera Visual Box con 6 cassetti H=112 mm
1	Kit 2 montanti biasolati	1	Cestino capacità 30 L
1	Kit 2 pannelli forati/mensole con 1 bordo fermacasse	2	Porta bombolette inclinato a 2 posti
1	Kit 2 supporti inclinati con binario	1	Tasca porta documenti A4
1	Lampada doppia	1	Kit porta rotolo con carta Ø=130 mm
1	Pensile vasistas senza serratura	3	Gancio Unipok per utensili - confezione 30 pezzi
1	Barra led	1	Barra aggancio con 4 contenitori Picking Box misura 1
1	Coppia staffe di fissaggio pensile su montanti	1	Barra aggancio con 3 contenitori Picking Box misura 2

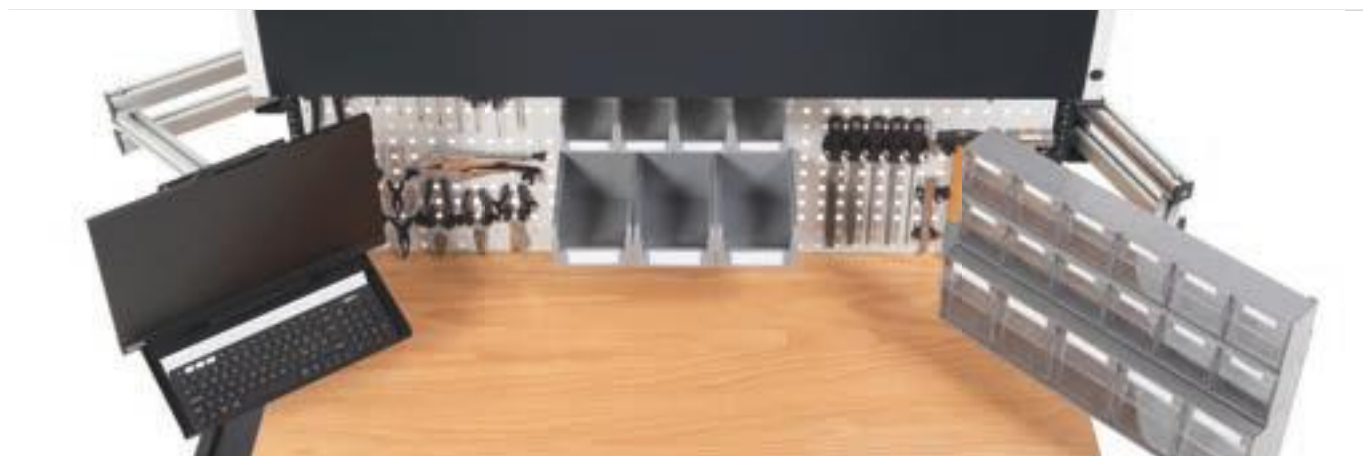

# ERGO WORK



ART.	Lmm	Pmm	Hmm		RAL	€
<b>DYNAMIC1505</b>	1497/1672	780	1983/2383	400	7035+7016	2785,50

Composto da:

qtà	descrizione
1	Banco smontato regolabile elettricamente
1	Armadio L=500 mm con 1 cassetto H=150 mm
1	Coperchio per armadio L=500 mm
1	Coppia supporti per armadio
1	Telaio portaprese aggiuntivo completo di tamponi e angolari
1	Kit 2 montanti biasolati
1	Coppia supporti per parete attrezzata L=1000 mm
1	Kit 2 supporti inclinati con binario
1	Lampada doppia
1	Kit 3 pannelli forati/mensole con 2 bordi fermacasse
1	Pannello forato electric
4	Kit 2 contenitori Picking Box misura 3A2

qtà	descrizione
1	Magnetotermico differenziale
1	Multipresa schuko a 4 scomparti
2	Multipresa schuko a 2 scomparti
1	Cavo di collegamento wieland schuko/francese
1	Coppia squadrette a L
1	Snodo per piastra
1	Piastra porta monitor con standard VESA
2	Pannello forato/mensola con 1 bordo fermacasse
2	Kit cerniere per pannello forato
2	Barra aggancio con 4 contenitori Picking Box misura 1
4	Barra aggancio con 3 contenitori Picking Box misura 2
2	Porta bombolette inclinato a 2 posti



PORTATA



RAL 7035+RAL 7016



# TOOL ORGANIZER







**Gancio Unipok per utensili - confezione 30 pezzi**

Con una confezione si possono agganciare fino a 30 utensili

ART.	pz. per confezione	colore	€
FBLIT009007	30	Nero	13,20



Unipok sono i **ganci universali** di Fami che, grazie al sistema a vite, possono essere posizionati su pareti forate o pannelli in legno. Ogni Unipok può essere posizionato con diverse inclinazioni per poter fissare utensili di volumi e dimensioni differenti. Libera la tua fantasia per organizzare al meglio la tua parete forata da muro o da banco e la tua parete in legno per avere sempre tutto a portata di mano!

Con Unipok l'ordine è un gioco da ragazzi!



Fissaggio su legno



Fissaggio su pannello forato

**In 4 posizioni tutte le combinazioni che vuoi!**





**Gancio con puntale**

ART.	L mm	P mm	H mm	multiplo d'ordine	€
FBLIT030000	36	78	42	10	1,80
FBLIT031000	36	128	42	10	1,80
FBLIT032000	36	178	42	10	1,80

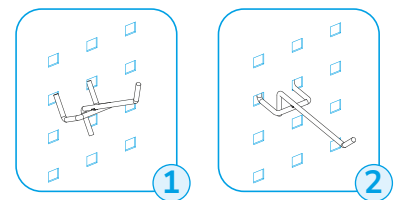

1

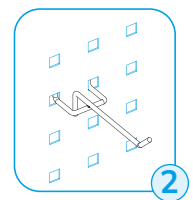

2

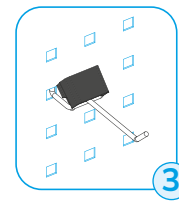

3

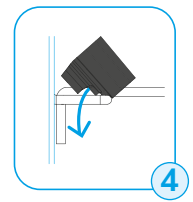

4

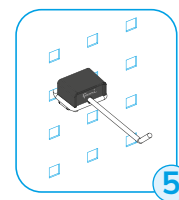

5

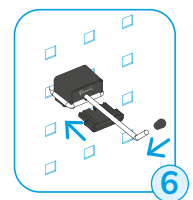

6

Il blocco di sicurezza ferma il gancio in posizione orizzontale e ne evita il movimento durante le operazioni di recupero/deposito utensili.





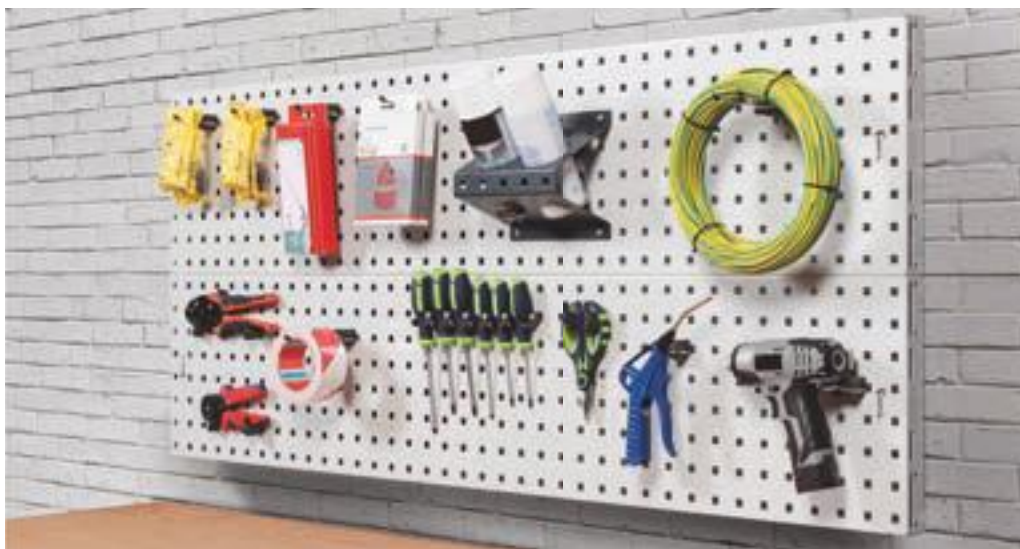

Pannelli forati vedi pag. 60  
Fissaggio a muro dei pannelli forati vedi pag. 62  
Ganci Unipok vedi pag. 85  
Ganci The Block vedi pag. 86  
Accessori Iron Team vedi pag. 90



### CREARE IL PERFETTO 5S SHADOW TOOL BOX CON PIKPAD!

Con **Pikpad** è possibile allestire un **5S shadow tool box** organizzato nel minimo dettaglio. Il fondo a foro quadro 10x10 del vassoio consente l'installazione di **Unipok** per creare **kit su misura** per ogni lavoro da svolgere e, grazie alle pratiche **etichette utensili**, sarà possibile identificare la tipologia di attrezzo che deve alloggiare in ogni spazio realizzato.

Pikpad è fornito completo di un set di 5 fogli adesivi:

- 4 fogli con più di 250 etichette di utensili (forma utensile + misura)
- 1 foglio non pretagliato per realizzare adesivi personalizzati



Unipok deve essere acquistato separatamente

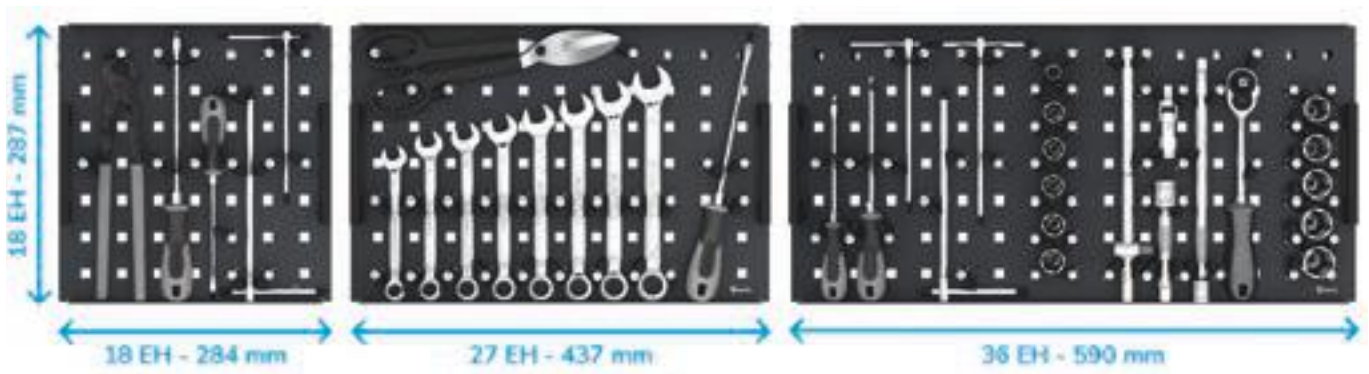

#### Vassoio Pikpad 5S shadow tool box

ART.	larghezza EH	profondità EH	L mm	P mm	H mm	RAL	€
FBLIT033039	18	18	284	287	50	7016	42,00
FBLIT034039	27	18	437	287	50	7016	51,00
FBLIT035039	36	18	590	287	50	7016	60,00

Unipok e attrezzi esclusi





### Sostegno da tavolo per vassoio Pikpad 5S shadow tool box

ART.	L mm	P mm	H mm	RAL	€
PIKPAD001	653	255	198	7016	39,60
PIKPAD002	959	255	198	7016	43,20
PIKPAD003	1444	255	198	7016	54,90

### 3 POSIZIONI DI REGOLAZIONE

Il **profilo brevettato** integrato nella parte posteriore di Pikpad consente di **regolare** il vassoio in **3 diverse posizioni**. È possibile, così, adattare l'inclinazione di Pikpad in base all'altezza e alla postura dell'utilizzatore per poter avere tutto a portata di mano e lavorare seguendo i principi dell'**ergonomia**.



### ORGANIZZAZIONE MOBILE

I 5S shadow tool box rendono mobile l'organizzazione dell'attrezzatura in quanto possono essere installati su diversi supporti e facilmente movimentati tramite maniglie laterali. Sono posizionabili su piani di lavoro tramite l'apposito sostegno da tavolo, sui montanti delle pareti attrezzate allestite con barre in alluminio e all'interno di cassette. In quest'ultimo caso, è possibile aumentare esponenzialmente l'organizzazione interna delle cassettiere integrando Pikpad con i tradizionali materiali di separazione come cassette divisorio e divisori in metallo.



# IRONTEAM

## ACCESSORI UNIVERSALI



Fissaggio su legno



Fissaggio su pannello forato



Fissaggio su muro

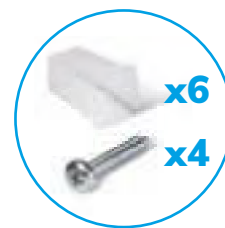

Set di fissaggio su legno e pannello forato incluso



**Porta silicone inclinato a 2 posti**

ART.	Lmm	Pmm	Hmm	Ø foro mm	RAL	€
FBLIT008039	150	71	96	61	7016	13,50



**Porta bombolette inclinato a 2 posti**

ART.	Lmm	Pmm	Hmm	Ø foro mm	RAL	€
FBLIT007039	188	111	172	70	7016	13,50



**Porta bombolette a 6 posti**

ART.	Lmm	Pmm	Hmm	RAL	€
FBLIT010039	455	75	167	7016	25,50



**Kit porta contenitore con contenitore salviette lavamani**

ART.	RAL	€
FBLIT006039	7016	85,20



**Kit porta rotolo con carta Ø=240 mm**

ART.	Lmm	Pmm	Hmm	RAL	€
FBLIT004039	297	275	270	7016	49,80



**Kit porta rotolo con carta Ø=130 mm**

ART.	Lmm	Pmm	Hmm	RAL	€
FBLIT003039	257	135	168	7016	32,10



**Porta flacone igienizzante reversibile**

ART.	Lmm	Pmm	Hmm	RAL	€
FBLIT002039	113	100	62	7016	15,00



**Dispenser per guanti**

ART.	Lmm	Pmm	Hmm	RAL	€
FBLIT005039	247	81	132	7016	13,20





Calamita completa di clip e vite - confezione 10 pezzi



ART.	pz. per confezione	Ø mm	finitura	€
FBL95410000	10	20	Zincato	49,20



Pensile con porta

ART.	L mm	P mm	H mm	KG	RAL	€
FBL8015C000PD	460	250	456	25	7035+7016	102,00
FBL8015C00004	460	250	456	25	5012	99,00





**Barra aggancio con 4 contenitori Picking Box misura 1**

ART.	L mm	P mm	H mm	colore contenitori	€
FBLIT011000	445	168	85	Grigio scuro	9,60
FBLIT012000	445	168	85	Nero	15,90



**Barra aggancio con 3 contenitori Picking Box misura 2**

ART.	L mm	P mm	H mm	colore contenitori	€
FBLIT013000	447	233	123	Grigio scuro	13,20
FBLIT014000	447	233	123	Nero	21,90



**Barra aggancio per contenitori Picking Box misura 1/2**

ART.	L mm	P mm	H mm	finitura	€
FBLIT020099	445	9	85	Zincato	4,20



**Kit porta contenitore**

ART.	L cinghia mm	RAL	€
FBLIT018039	910	7016	32,70



**Tasca porta documenti A4**

ART.	L mm	P mm	H mm	RAL	€
FBLIT001039	365	68	187	7016	18,60



**Kit pronto soccorso**

ART.	L mm	P mm	H mm	€
FBLIT024000	256	90	190	28,80



**Porta estintore con estintore da 2 kg**

ART.	L mm	P mm	H mm	€
FBLIT023000	115	115	400	64,20



**Sella reggicavi**

ART.	L mm	P mm	H mm	RAL	€
FBLIT019039	220	95	101	7016	21,00

ZINCATO
  RAL 5012
  RAL 7035 + RAL 7016
  RAL 7016





### Piastra porta monitor con squadrette

ART.	L mm	P mm	H mm	RAL	€
ERGOWORK014	225/129	119/225	225	7016	41,10

Composto da:

qtà	descrizione
1	Coppia squadrette a L
1	Snodo per piastra
1	Piastra porta monitor con standard VESA



### Cestino capacità 30 L

ART.	L mm	P mm	H mm	L	RAL	€
FBLIT025039	387	277	394	30	7016	89,70



### Valigetta con contenitori

ART.	L mm	P mm	H mm	€
FBLIT022001	440	350	80	49,80

### Kit porta valigetta

ART.	RAL	€
FBLIT021039	7016	43,50



Mensola piccola reversibile

ART.	L mm	P mm	H mm	RAL	€
FBLIT017039	303	317	144	7016	21,90



Mensola grande reversibile

ART.	L mm	P mm	H mm	RAL	€
FBLIT016039	455	317	144	7016	24,30



Kit 2 contenitori Picking Box misura 3A2

ART.	L mm	P mm	H mm	colore	€
FBLIT027001	200	350	145	Grigio scuro	11,70



Kit 10 contenitori

ART.	€
FBLIT028000	11,40



Mensola porta oggetti reversibile

ART.	L mm	P mm	H mm	RAL	€
FBLIT015039	455	160	40	7016	25,20



Porta punte

ART.	L mm	P mm	H mm	finitura	€
FBLIT0260ZZ	155	84	39	Inox	27,60

Il porta punte può essere utilizzato all'interno della mensola porta oggetti reversibile.



CAPACITÀ



INOX



RAL 7016



### Supporto per magnetotermico differenziale

ART.	L mm	P mm	H mm	RAL	€
FBLET003039	159	32	92	7016	13,50



### Magnetotermico differenziale 2P+T 16A, 30mA TYPE A

ART.	L mm	P mm	H mm	colore	€
FBLET012007	159	59	90	Nero	145,20



### Supporto multipresa a 2 scomparti

ART.	L mm	P mm	H mm	RAL	€
FBLET001039	148	32	92	7016	13,50



### Supporto multipresa a 4 scomparti

ART.	L mm	P mm	H mm	RAL	€
FBLET002039	249	32	92	7016	15,00



### Multipresa a 2 scomparti

ART.	L mm	P mm	H mm	tipo presa	colore	€
FBLET004007	148	59	46	Schuko	Nero	19,50
FBLET006007	148	59	46	Svizzera	Nero	42,00
FBLET008007	148	59	46	Inglese	Nero	34,20
FBLET010007	148	59	46	Francese	Nero	19,50



### Multipresa a 4 scomparti

ART.	L mm	P mm	H mm	tipo presa	colore	€
FBLET005007	248	59	46	Schuko	Nero	25,50
FBLET007007	248	59	46	Svizzera	Nero	48,00
FBLET009007	248	59	46	Inglese	Nero	59,40
FBLET011007	248	59	46	Francese	Nero	25,50



### Cavo di collegamento wieland con spine in/out

ART.	L mm	P mm	H mm	colore	€
FBLET013007	200	28	13	Nero	18,00



### Connettore ad H wieland a 2 output

ART.	L mm	P mm	H mm	colore	€
FBLET015007	60	35	35	Nero	18,00



### Cavo di collegamento Wieland

ART.	L mm	P mm	H mm	tipo spina	colore	€
FBLET016007	3000	50	50	Schuko/Francese	Nero	18,00
FBLET017007	3000	50	50	Inglese	Nero	21,90
FBLET018007	3000	50	50	Svizzera	Nero	20,10



### Cavo di collegamento wieland con spine in/out

ART.	L mm	P mm	H mm	colore	€
FBLET014007	1500	28	13	Nero	20,10





**Presse usb dati**

ART.	Ø mm	L mm	H mm	colore	€
FBLET019007	59	70	54	Nero	144,90



**Presse usb ricarica**

ART.	Ø mm	L mm	H mm	colore	€
FBLET020007	59	70	54	Nero	119,10



**Lampada L=988 mm con staffe di fissaggio**

ART.	L mm	temperatura colore K	Watt	Hz	Lumen	RAL	€
IRONTEAM001	988	4000	27	50	5058	7016	253,80



**Lampada L=1473 mm con staffe di fissaggio**

ART.	L mm	temperatura colore K	Watt	Hz	Lumen	RAL	€
IRONTEAM002	1473	4000	41	50	7588	7016	315,30





### Lampada singola

Senza pulsante on/off

ART.	L mm	temperatura colore K	Watt	Hz	Lumen	RAL	€
FBL99400008	955	4000	15	50/60	1500	7035	116,70
FBL99450008	1440	4000	20	50/60	2000	7035	127,80



### Lampada doppia

Senza pulsante on/off

ART.	L mm	temperatura colore K	Watt	Hz	Lumen	RAL	€
FBL99400108	955	4000	15	50/60	3000	7035	150,60
FBL99450108	1440	4000	20	50/60	4000	7035	164,10



Esempio di fissaggio al binario aereo



Esempio di fissaggio al pannello forato tramite staffe



Esempio di fissaggio con calamita



RAL 7016



RAL 7035



# FLEXA

## ARMADI CON CASSETTI SERIE START



Portata cassetti da 50  
a 70 kg

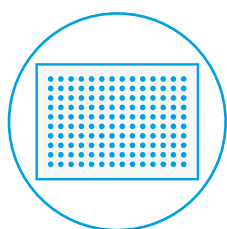

Cassetti forati

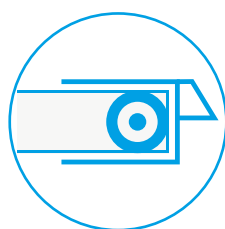

Cuscinetti a sfera



Chiusura a chiave

# FLEXA

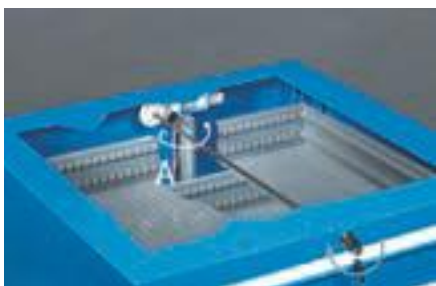

## SERRATURA

La serratura a cilindro si collega tramite un'asta quadra al gruppo di chiusura posteriore composto di un elemento rotante in materiale plastico e un'asta di chiusura in lamiera di acciaio. Girando la chiave si aziona il sistema a camme del gruppo di chiusura che fa ruotare l'asta posteriore (A).



## TOP A 3 BORDI RIVESTITO IN PVC

Il top a 3 bordi rivestito in PVC protegge la parte superiore dell'armadio e, grazie ai bordi rialzati, evita la caduta del materiale posizionato su di esso.



## LIBERAMENTE ORGANIZZABILE

Il cassetto può essere suddiviso internamente tramite **cassette divisorio portaminuterie e divisori longitudinali e trasversali in metallo**. Quest'ultimi sono fissati al fondo forato del cassetto tramite viti per evitare la fuoriuscita del materiale stoccato.



## CASSETTI FORATI



ORGANIZZAZIONE AL MILLIMETRO  
Fori e scanalature sui cassetti facilitano la suddivisione interna del cassetto per una perfetta organizzazione di utensili e materiali.



**ESTRAZIONE TOTALE  
100%**



**PORTATA  
50 / 70 kg**

## COLORI

L'armadio Flexa è disponibile in 3 combinazioni di colore.

## ARMADIO



7016  
7035



7035



5012

## LEGENDA

EH		36X27 EH	54X27 EH
	<b>Dimensioni armadio</b>	L= 717	1023
		P= 600	600
	<b>Dimensioni interne cassetto</b>	L= 602	908
		P= 449	449

**Cassettiera L=717 mm - Cassetti ad estrazione totale**



ART.	Lmm	Pmm	Hmm	cassetti							RAL	€
				n.	h 75 mm	h 100 mm	h 150 mm	h 200 mm	KG	👉		
<b>FDF109054PD</b>	717	600	1002	7	2	1	3	1	70	100%	7035+7016	710,70
<b>FDF10905408</b>	717	600	1002	7	2	1	3	1	70	100%	7035	648,90
<b>FDF10905404</b>	717	600	1002	7	2	1	3	1	70	100%	5012	648,90
<b>FDF109056PD</b>	717	600	1002	9	-	9	-	-	70	100%	7035+7016	822,00
<b>FDF10905608</b>	717	600	1002	9	-	9	-	-	70	100%	7035	754,20
<b>FDF10905604</b>	717	600	1002	9	-	9	-	-	70	100%	5012	754,20



ART.	L mm	P mm	H mm	KG	cassetti					ruote			RAL	€			
					n.	h 100 mm	h 200 mm	KG	👉	Ø mm	H mm	materiale			👉	👉	👉
<b>FDGD56001PD</b>	794	600	853	225	5	4	1	70	100%	100	128	Gomma standard	1	1	2	7035+7016	639,90
<b>FDGD5600108</b>	794	600	853	225	5	4	1	70	100%	100	128	Gomma standard	1	1	2	7035	602,70
<b>FDGD5600104</b>	794	600	853	225	5	4	1	70	100%	100	128	Gomma standard	1	1	2	5012	602,70

 RUOTA GIREVOLE

 RUOTA GIREVOLE CON FRENO

 RUOTA FISSA

**FLEXA****L= 717 MM****MATERIALE DI SEPARAZIONE****36X27 EH****Top a 4 bordi rivestito in pvc**

ART.	L mm	P mm	H mm	colore	€
FDf99400107	717	602	22	Nero	65,10



ART.	adatto per cassetto H mm	componenti	€
FFH10051000	50/300	3 x Divisorio a 3 canali 9 x Divisorio a 4 canali 12 x Divisorio trasversale L=47 mm 36 x Divisorio trasversale L=36 mm	30,00



ART.	adatto per cassetto H mm	componenti	€
FFH10051300	50/300	18 x Divisorio trasversale L=47 mm 12 x Divisorio trasversale L=73 mm 6 x Divisorio a 2 canali 6 x Divisorio a 3 canali	27,00



ART.	adatto per cassetto H mm	componenti	€
FFH10051500	50/300	20 x Divisorio trasversale L=36 mm 20 x Divisorio trasversale L=47 mm 6 x Divisorio a 3 canali 5 x Divisorio a 4 canali 1 x Porta chiavi a brugola	30,00

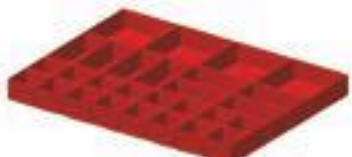

ART.	adatto per cassetto H mm	componenti	€
FFH10071800	75	16 x Cassetta divisorio 75x75 mm 8 x Cassetta divisorio 150x75 mm 4 x Cassetta divisorio 150x150 mm	30,60



ART.	adatto per cassetto H mm	componenti	€
FFH10071600	75	12 x Cassetta divisorio 150x75 mm	27,90
FFH10101600	100/125	6 x Cassetta divisorio 150x150 mm	32,70



ART.	adatto per cassetto H mm	componenti	€
FFH10070500	75	2 x Divisorio longitudinale fessurato L=457 mm 3 x Divisorio trasversale L=202 mm	15,30
FFH10100500	100/125		15,90
FFH10150500	150/175		21,30
FFH10200500	200/250		30,30



ESTRAZIONE



PORTATA



RAL 7035 + RAL 7016



RAL 5012



RAL 7035

Cassettiera L=1023 mm - Cassetti ad estrazione totale



ART.	L mm	P mm	H mm	cassetti							RAL	€
				n.	h 75 mm	h 100 mm	h 150 mm	h 200 mm				
FDL109054PD	1023	600	1002	7	2	1	3	1	50	100%	7035+7016	871,50
FDL10905408	1023	600	1002	7	2	1	3	1	50	100%	7035	800,40
FDL10905404	1023	600	1002	7	2	1	3	1	50	100%	5012	800,40
FDL109056PD	1023	600	1002	9	-	9	-	-	50	100%	7035+7016	1019,70
FDL10905608	1023	600	1002	9	-	9	-	-	50	100%	7035	927,00
FDL10905604	1023	600	1002	9	-	9	-	-	50	100%	5012	927,00





**FLEXA****MATERIALE DI SEPARAZIONE****L= 1023 MM****54X27 EH****Top a 3 bordi rivestito in pvc**

ART.	L mm	P mm	H mm	colore	€
FDL91500107	1024	601	30	Nero	83,70



ART.	adatto per cassetto H mm	componenti	€
FFH40051200	50/300	15 x Divisorio trasversale L=36 mm 10 x Divisorio trasversale L=47 mm 6 x Divisorio trasversale L=73 mm 6 x Divisorio a 2 canali 6 x Divisorio a 3 canali 6 x Divisorio a 4 canali	37,20



ART.	adatto per cassetto H mm	componenti	€
FFH40051500	50/300	30 x Divisorio trasversale L=36 mm 10 x Divisorio trasversale L=47 mm 6 x Divisorio a 3 canali 12 x Divisorio a 4 canali	39,60



ART.	adatto per cassetto H mm	componenti	€
FFH40071100	75	18 x Cassetta divisorio 150x150 mm	39,90
FFH40101100	100/125		45,00



ART.	adatto per cassetto H mm	componenti	€
FFH40071300	75	12 x Cassetta divisorio 150x75 mm 12 x Cassetta divisorio 150x150 mm	41,70
FFH40101300	100/125		48,00



ART.	adatto per cassetto H mm	componenti	€
FFH40071600	75	20 x Cassetta divisorio 75x75 mm 14 x Cassetta divisorio 150x75 mm 6 x Cassetta divisorio 150x150 mm	45,90

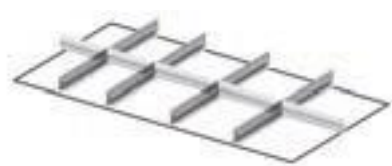

ART.	adatto per cassetto H mm	componenti	€
FFH40070500	75	4 x Divisorio longitudinale fessurato L=457 mm 2 x Divisorio trasversale L=151 mm 3 x Divisorio trasversale L=202 mm	22,80
FFH40100500	100/125		26,10
FFH40150500	150/175		38,10
FFH40200500	200/250		55,80



ESTRAZIONE



PORTATA



RAL 7035 + RAL 7016



RAL 5012



RAL 7035



# MASTER DE

## ARMADI CON CASSETTI SERIE PRO



Portata cassette da 50  
a 100 kg

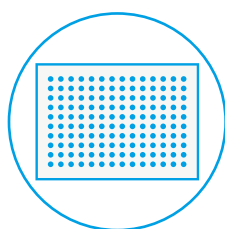

Cassetti forati



Cuscinetti a sfera



Chiusura a chiave

# MASTER DE



## TOP IN ACCIAIO INOX SATINATO

Il top in acciaio inox satinato permette di effettuare lavorazioni e interventi senza danneggiare l'armadio. Presenta un elevato livello di resistenza alla corrosione e al calore.



## TOP IN MULTIPLEX

Il top in multiplex trasforma la parte superiore dell'armadio in un piano di lavoro solido e robusto. È resistente a urti e graffi ed è adatto per operazioni pesanti.



## TOP IN ACCIAIO GOMMATO

Il top è realizzato in acciaio zincato e rivestito con gomma antiolio. È particolarmente indicato in caso di uso di oli o per interventi che impiegano strumenti da taglio.



## TOP A 3 BORDI RIVESTITO IN PVC

Il top a 3 bordi rivestito in PVC protegge la parte superiore dell'armadio e, grazie ai bordi rialzati, evita la caduta del materiale posizionato su di esso.



## ZOCCOLI

Gli zoccoli hanno una duplice funzione: rialzano l'armadio a cassetti dal pavimento e ne permettono la movimentazione tramite carrelli elevatori o transpallet.



## SERRATURA

La serratura a cilindro si collega tramite un'asta quadra al gruppo di chiusura posteriore composto di un elemento rotante in materiale plastico e un'asta di chiusura in lamiera di acciaio. Girando la chiave si aziona il sistema a camme del gruppo di chiusura che fa ruotare l'asta posteriore (A).



## ESTRAZIONE TOTALE



**LIBERTÀ NELLA CONFIGURAZIONE**  
Modifica velocemente e facilmente l'estrazione del cassetto per aumentare la portata fino a 100 kg.



## GUIDE AD ALTE PRESTAZIONI



**CORRERE SENZA PROBLEMI**  
Le guide lunghe come i cassetti permettono di spostare il cuscinetto nella parte frontale dell'armadio aumentando visibilità, portata ed estrazione.



## CASSETTI FORATI



**ORGANIZZAZIONE AL MILLIMETRO**  
Fori e scanalature sui cassetti facilitano la suddivisione interna del cassetto per una perfetta organizzazione di utensili e materiali.

# MASTER DE

## ESTRAZIONE E GESTIONE DEL CASSETTO

Il cassetto Master DE rappresenta una rivoluzione nel mondo dell'arredo industriale in quanto è stato ideato e sviluppato per essere personalizzato autonomamente in termini di estrazione/portata e suddivisione interna.

## LIBERAMENTE CONFIGURABILE

La nuova guida ad **estrazione flessibile** permette la regolazione meccanica del fermo posteriore del cassetto/piano estraibile, in **3 diverse posizioni** ottenendo così **3 portate differenti: 50, 75, 100 kg**. Un'etichetta indica la portata massima del cassetto a seconda della sua estrazione e del tipo di guida.

## GUIDA FLESSIBILE CONFIGURATA PER ESTRAZIONE TOTALE 50 KG



## GUIDA FLESSIBILE CONFIGURATA PER ESTRAZIONE TOTALE 75 KG



## GUIDA FLESSIBILE CONFIGURATA PER ESTRAZIONE PARZIALE 100 KG



## LIBERAMENTE ORGANIZZABILE

Il cassetto può essere suddiviso internamente tramite **cassette divisorio portaminuterie e divisori longitudinali e trasversali in metallo**. Quest'ultimi sono fissati al fondo forato del cassetto tramite viti per evitare la fuoriuscita del materiale stoccato.



# MASTER DE



Le innovazioni che semplificano l'identificazione dei contenuti all'interno dei cassetti.

Con la tecnologia Syfront di Sylogik® il frontale del cassetto non è più solo un elemento di chiusura, ma diventa una vera interfaccia visiva.

- Personalizzazione con elementi estetici e decorativi
- Input utente: etichette per la descrizione e catalogazione del contenuto
- Output utente: possibilità di inserire messaggi visivi o descrittivi sulla maniglia

## MANIGLIE PERSONALIZZABILI

**UNA MINIERA DI INFORMAZIONI**  
Inserisci nella maniglia codici a barre, etichette o immagini per conoscere velocemente il contenuto di ogni singolo cassetto.



## COLORI

L'armadio Master DE è disponibile in 3 combinazioni di colore per il corpo armadio, mentre la maniglia è disponibile solo in Dark Grey.

## ARMADIO



7016  
7035



7035



5012

## MANIGLIA FRONTALE



Dark Grey

## LEGENDA

**EH**

**36X36 EH** **54X36 EH**

**PR**

Piano regolabile



**Dimensioni armadio**

L=	714	1020
P=	726	726



**Dimensioni interne cassetto**

L=	602	908
P=	602	602





# MASTER DE 36X36 EH

Cassettiera L=714 mm - Cassetti ad estrazione totale



ART.	Lmm	Pmm	Hmm	cassetti									RAL	€
				n.	h 50 mm	h 75 mm	h 100 mm	h 150 mm	h 200 mm	h 300 mm	KG	↓		
D33A100C0100104	714	726	1000	6	-	-	-	6	-	-	100-75-50	92-96-100%	5012	780,60
D33A100C0100108	714	726	1000	6	-	-	-	6	-	-	100-75-50	92-96-100%	7035	780,60
D33A100C01001PD	714	726	1000	6	-	-	-	6	-	-	100-75-50	92-96-100%	7035+7016	819,00
D33A100C0100204	714	726	1000	7	1	2	2	-	1	1	100-75-50	92-96-100%	5012	837,30
D33A100C0100208	714	726	1000	7	1	2	2	-	1	1	100-75-50	92-96-100%	7035	837,30
D33A100C01002PD	714	726	1000	7	1	2	2	-	1	1	100-75-50	92-96-100%	7035+7016	897,60



ART.	Lmm	Pmm	Hmm	cassetti									RAL	€
				n.	h 50 mm	h 75 mm	h 100 mm	h 150 mm	h 200 mm	KG	↓			
D33A100C0100304	714	726	1000	8	1	2	2	2	1	100-75-50	92-96-100%	5012	903,90	
D33A100C0100308	714	726	1000	8	1	2	2	2	1	100-75-50	92-96-100%	7035	903,90	
D33A100C01003PD	714	726	1000	8	1	2	2	2	1	100-75-50	92-96-100%	7035+7016	967,50	
D33A100C0100404	714	726	1000	9	-	-	9	-	-	100-75-50	92-96-100%	5012	969,00	
D33A100C0100408	714	726	1000	9	-	-	9	-	-	100-75-50	92-96-100%	7035	969,00	
D33A100C01004PD	714	726	1000	9	-	-	9	-	-	100-75-50	92-96-100%	7035+7016	1039,20	



# MASTER DE MATERIALE DI SEPARAZIONE

L= 714 MM

36X36 EH



ART.	adatto per cassetto H mm	componenti	€
FFH20051500	50/300	35 x Divisorio trasversale L=73 mm 16 x Divisorio a 2 canali	33,30



ART.	adatto per cassetto H mm	componenti	€
FFH20051600	50/300	50 x Divisorio trasversale L=47 mm 16 x Divisorio a 3 canali	35,40



ART.	adatto per cassetto H mm	componenti	€
FFH20051700	50/300	65 x Divisorio trasversale L=36 mm 16 x Divisorio a 4 canali	38,70



ART.	adatto per cassetto H mm	componenti	€
FFH20051200	50	16 x Cassetta divisorio 75x75 mm	30,60
FFH20071200	75	16 x Cassetta divisorio 150x75 mm 4 x Cassetta divisorio 150x150 mm	40,50



ART.	adatto per cassetto H mm	componenti	€
FFH20051300	50	16 x Cassetta divisorio 150x75 mm 8 x Cassetta divisorio 150x150 mm	26,70
FFH20071300	75		36,60
FFH20101300	100/125		42,90



ART.	adatto per cassetto H mm	componenti	€
FFH20050600	50	2 x Divisorio longitudinale fessurato L=610 mm 3 x Divisorio trasversale L=202 mm	11,70
FFH20070600	75		14,70
FFH20100600	100/125		16,50
FFH20150600	150/175		22,50
FFH20200600	200/250		34,20
FFH20300600	300		60,00



ESTRAZIONE



PORTATA



RAL 7035 + RAL 7016



RAL 5012



RAL 7035

# MASTER DE 54X36 EH

Cassettiera L=1020 mm - Cassetti ad estrazione totale



ART.	L mm	P mm	H mm	cassetti				RAL	€
				n.	h 150 mm	KG			
D53A100C0100104	1020	726	1000	6	6	100-75-50	92-96-100%	5012	936,30
D53A100C0100108	1020	726	1000	6	6	100-75-50	92-96-100%	7035	936,30
D53A100C01001PD	1020	726	1000	6	6	100-75-50	92-96-100%	7035+7016	1046,40



ART.	L mm	P mm	H mm	cassetti									RAL	€
				n.	h 50 mm	h 75 mm	h 100 mm	h 150 mm	h 200 mm	h 300 mm	KG			
D53A100C0100204	1020	726	1000	7	1	2	2	-	1	1	100-75-50	92-96-100%	5012	992,40
D53A100C0100208	1020	726	1000	7	1	2	2	-	1	1	100-75-50	92-96-100%	7035	992,40
D53A100C01002PD	1020	726	1000	7	1	2	2	-	1	1	100-75-50	92-96-100%	7035+7016	1124,70
D53A100C0100304	1020	726	1000	8	1	2	2	2	1	-	100-75-50	92-96-100%	5012	1077,00
D53A100C0100308	1020	726	1000	8	1	2	2	2	1	-	100-75-50	92-96-100%	7035	1077,00
D53A100C01003PD	1020	726	1000	8	1	2	2	2	1	-	100-75-50	92-96-100%	7035+7016	1230,00

# MASTER DE MATERIALE DI SEPARAZIONE

L= 1020 MM 54X36 EH



ART.	adatto per cassetto H mm	componenti	€
FFH50051900	50/300	30 x Divisorio trasversale L=36 mm 10 x Divisorio trasversale L=47 mm 8 x Divisorio a 3 canali 16 x Divisorio a 4 canali	47,10



ART.	adatto per cassetto H mm	componenti	€
FFH50050800	50	12 x Cassetta divisorio 150x75 mm 18 x Cassetta divisorio 150x150 mm	38,40
FFH50070800	75		51,90
FFH50100800	100/125		58,20



ART.	adatto per cassetto H mm	componenti	€
FFH50051700	50	20 x Cassetta divisorio 75x75 mm 14 x Cassetta divisorio 150x75 mm 12 x Cassetta divisorio 150x150 mm	42,60
FFH50071700	75		56,10



ART.	adatto per cassetto H mm	componenti	€
FFH50051800	50	24 x Cassetta divisorio 150x150 mm	36,90
FFH50071800	75		50,10
FFH50101800	100/125		55,20

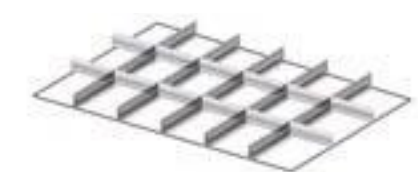

ART.	adatto per cassetto H mm	componenti	€
FFH50051300	50	5 x Divisorio longitudinale fessurato L=610 mm 12 x Divisorio trasversale L=151 mm	28,80
FFH50071300	75		23,40
FFH50101300	100/125		29,10
FFH50151300	150/175		42,30
FFH50201300	200/250		73,20
FFH50301300	300		156,90



ART.	adatto per cassetto H mm	componenti	€
FFH50050700	50	4 x Divisorio longitudinale fessurato L=610 mm 2 x Divisorio trasversale L=151 mm 3 x Divisorio trasversale L=202 mm	21,00
FFH50070700	75		16,20
FFH50100700	100/125		19,80
FFH50150700	150/175		29,10
FFH50200700	200/250		51,90
FFH50300700	300		116,70



ESTRAZIONE



PORTATA



RAL 7035 + RAL 7016



RAL 5012



RAL 7035

# MASTER DE 54X36 EH

Armadio L=1020 mm



ART.	L mm	P mm	H mm	n. coppia porte	RAL	€
D53A100C0100504	1020	726	1000	1	5012	541,50
D53A100C0100508	1020	726	1000	1	7035	541,50
D53A100C01005PD	1020	726	1000	1	7035+7016	541,50



ART.	L mm	P mm	H mm	n. coppia porte	materiale porte	n. piano regolabile	RAL	€
D53A100C0100604	1020	726	1000	1	Policarbonato	1	5012	650,40
D53A100C0100608	1020	726	1000	1	Policarbonato	1	7035	650,40
D53A100C01006PD	1020	726	1000	1	Policarbonato	1	7035+7016	650,40

# MASTER DE ACCESSORI



## Top a 3 bordi rivestito in pvc

ART.	adatto per armadio EH	L mm	P mm	H mm	colore	€
M33T023AG003107	36x36	715	729	23	Nero	83,70
M53T023AG003107	54x36	1021	729	23	Nero	85,80



## Top in acciaio inox

ART.	adatto per armadio EH	L mm	P mm	H mm	€
M33T030MDNX710A	36x36	714	726	31	197,70
M53T030MDNX710A	54x36	1020	726	31	247,80



## Top in acciaio gommato

ART.	adatto per armadio EH	L mm	P mm	H mm	colore	€
M33T030MDGM7107	36x36	714	726	32	Nero	159,30
M53T030MDGM7107	54x36	1020	726	32	Nero	220,20



## Top in multiplex

ART.	adatto per armadio EH	L mm	P mm	H mm	€
M33T030MU000100	36x36	714	726	30	100,20
M53T030MU000100	54x36	1020	726	30	120,30



## Zoccolo per carrello elevatore e transpallet

ART.	adatto per armadio EH	L mm	P mm	H mm	RAL	€
M33Z10010000007	36x36	712	722	100	9005	93,60



## Chiusura per zoccolo

ART.	adatto per armadio L EH	L mm	P mm	H mm	RAL	€
M30Z10011000007	36	708	46	95	9005	19,20



## Coppia zoccoli per carrello elevatore e transpallet

ART.	adatto per armadio EH	L mm	P mm	H mm	RAL	€
M03Z10020000007	54x36	200	722	100	9005	74,40



## Chiusura per zoccolo

ART.	adatto per armadio L EH	L mm	P mm	H mm	RAL	€
M50Z10021000007	54	1014	46	95	9005	27,90



RAL 7035 + RAL 7016



RAL 5012



RAL 7035



RAL 9005



# MASTER

## ARMADI CON CASSETTI SERIE PRO+



Portata cassetti da 50  
a 200 kg

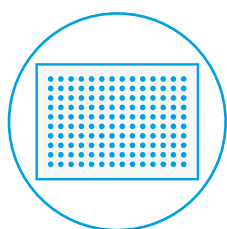

Cassetti forati



Cuscinetti a sfera

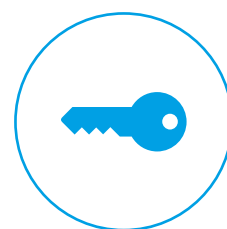

Chiusura a chiave

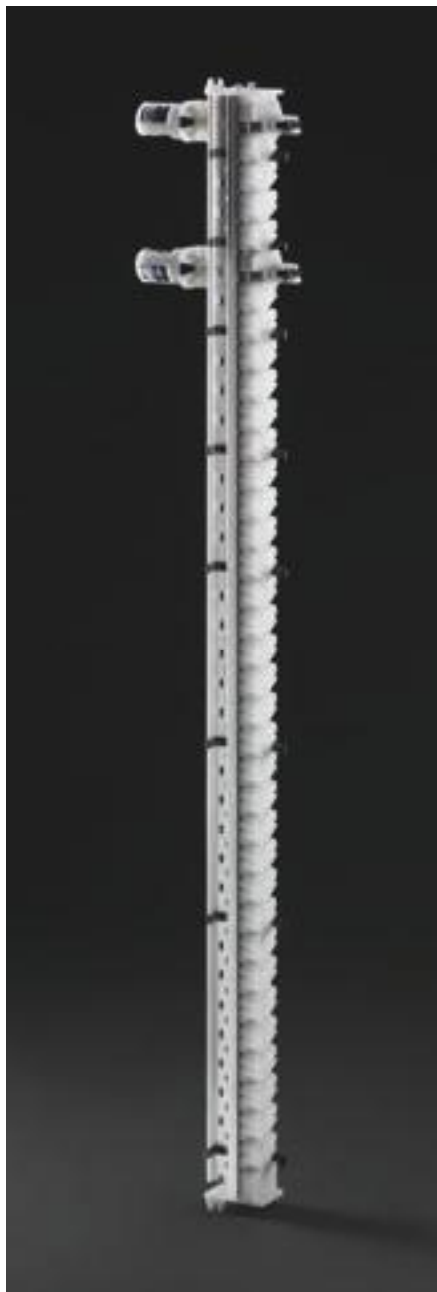

## ASTA VERTEBRATA ANTIRIBALTAMENTO

L'asta è in profilato d'alluminio e rimane sempre fissa, senza ruotare.

Il movimento di chiusura è ottenuto da **tasselli che si spostano verticalmente** sfruttando una delle forze elementari della fisica: **la gravità. Più il movimento è semplice, meno probabilità di rotture ci sono.**

L'asta è **forata a passo 25 mm** e consente l'applicazione di più teste di chiusura. Questo permette di dividere l'accesso ai cassetti in più gruppi. La divisione dei gruppi è configurabile in altezza.

## SISTEMA MECCANICO

Il sistema di comando meccanico del gruppo chiusura utilizza tecnologia Sylogik®. **Le differenze sono decisive.**

**Il sistema di trasmissione dal cilindro della serratura alla testa dell'asta è costituito da fili di acciaio con guaina elastica e movimento lineare.**

Rispetto ai comuni sistemi fissi ad asta quadra con movimento rotatorio, permette di svincolare il parallelismo della posizione del cilindro della serratura rispetto alla testa dell'asta. Questo consente al progettista di applicare il cilindro nel punto più idoneo dell'armadio.

**Il cilindro della serratura è appoggiato a un tamburo di rinvio** così da poter scegliere diverse case costruttrici di cilindri\*.

In questo modo l'armadio può essere integrato con altri preesistenti mantenendo lo stesso tipo di chiave.



\* Opzione a richiesta con sovrapprezzo



### ESTRAZIONE TOTALE



LIBERTÀ NELLA CONFIGURAZIONE  
Modifica velocemente e facilmente l'estrazione del cassetto per aumentare la portata fino a 100 kg.

### GUIDE AD ALTE PRESTAZIONI



CORRERE SENZA PROBLEMI  
Le guide lunghe come i cassetti permettono di spostare il cuscinetto nella parte frontale dell'armadio aumentando visibilità, portata ed estrazione.

### CASSETTI FORATI



ORGANIZZAZIONE AL MILLIMETRO  
Fori e scanalature sui cassetti facilitano la suddivisione interna del cassetto per una perfetta organizzazione di utensili e materiali.

# MASTER

## ESTRAZIONE E GESTIONE DEL CASSETTO

Il cassetto Master rappresenta una rivoluzione nel mondo dell'arredo industriale in quanto è stato ideato e sviluppato per essere personalizzato autonomamente in termini di estrazione/portata e suddivisione interna.

## LIBERAMENTE CONFIGURABILE

La nuova guida ad **estrazione flessibile** permette la regolazione meccanica del fermo posteriore del cassetto/piano estraibile, in **3 diverse posizioni** ottenendo così **3 portate differenti: 50, 75, 100 kg**. L'installazione dell'innovativa **guida telescopica** aumenta la portata del cassetto/piano estraibile fino a **200 kg**. Un'etichetta indica la portata massima del cassetto a seconda della sua estrazione e del tipo di guida.

### GUIDA FLESSIBILE CONFIGURATA PER ESTRAZIONE TOTALE 50 KG

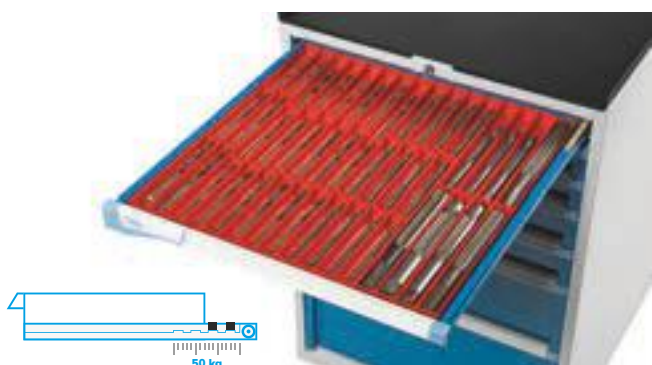

### GUIDA FLESSIBILE CONFIGURATA PER ESTRAZIONE PARZIALE 100 KG



### GUIDA FLESSIBILE CONFIGURATA PER ESTRAZIONE TOTALE 75 KG



### GUIDA TELESCOPICA CONFIGURATA PER ESTRAZIONE TOTALE 200 KG

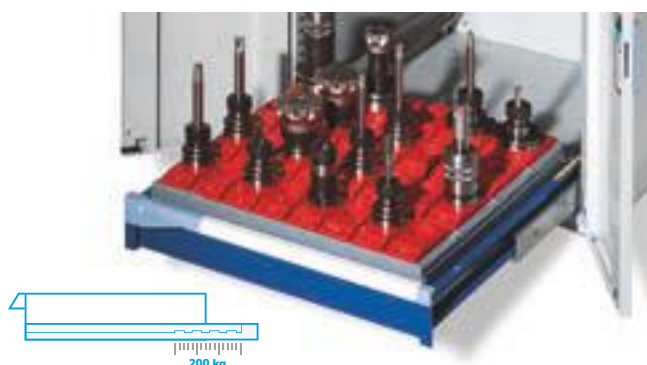

## LIBERAMENTE ORGANIZZABILE

Il cassetto può essere suddiviso internamente tramite **cassette divisorio portaminuterie** e **divisori longitudinali e trasversali in metallo**. Quest'ultimi sono fissati al fondo forato del cassetto tramite viti per evitare la fuoriuscita del materiale stoccato.



# MASTER



Le innovazioni che semplificano l'identificazione dei contenuti all'interno dei cassetti.

Con la tecnologia Syfront di Sylogik® il frontale del cassetto non è più solo un elemento di chiusura, ma diventa una vera interfaccia visiva.

- Personalizzazione con elementi estetici e decorativi
- Input utente: etichette per la descrizione e catalogazione del contenuto
- Output utente: possibilità di inserire messaggi visivi o descrittivi sulla maniglia

## MANIGLIE PERSONALIZZABILI

**UNA MINIERA DI INFORMAZIONI**  
Inserisci nella maniglia codici a barre, etichette o immagini per conoscere velocemente il contenuto di ogni singolo cassetto.



## MODULARITÀ

I diversi elementi che compongono la serie Master possono essere facilmente **integrati tra di loro per creare composizioni di arredo complete e pronte a tutto**. È possibile così creare, ad esempio, banconate con cassetti e porte corredate di piani a 4 bordi per effettuare manutenzioni e lavorazioni o per essere utilizzate come postazioni per accettazione clienti in negozi o magazzini.

Courtesy of Fridle Group





# MASTER



## TOP IN ACCIAIO INOX SATINATO

Il top in acciaio inox satinato permette di effettuare lavorazioni e interventi senza danneggiare l'armadio. Presenta un elevato livello di resistenza alla corrosione e al calore.



## TOP IN MULTIPLEX

Il top in multiplex trasforma la parte superiore dell'armadio in un piano di lavoro solido e robusto. È resistente a urti e graffi ed è adatto per operazioni pesanti.



## TOP IN ACCIAIO GOMMATO

Il top è realizzato in acciaio zincato e rivestito con gomma antiolio. È particolarmente indicato in caso di uso di oli o per interventi che impiegano strumenti da taglio.



## TOP A 3 BORDI RIVESTITO IN PVC

Il top a 3 bordi rivestito in PVC protegge la parte superiore dell'armadio e, grazie ai bordi rialzati, evita la caduta del materiale posizionato su di esso.



## ZOCOLI

Gli zoccoli hanno una duplice funzione: rialzano l'armadio a cassetti dal pavimento e ne permettono la movimentazione tramite carrelli elevatori o transpallet.



## RUOTE

Gli armadi possono essere forniti con ruote per trasformarli in pratici carrelli portautensili. Di serie sono allestiti con 2 ruote girevoli con freno e 2 ruote fisse.



## SISTEMA ANTIELUSIVO

**SICUREZZA AL PRIMO POSTO**  
Al contrario di altri armadi presenti in commercio, il sistema di chiusura brevettato non consente allo scassinatore di eludere la chiusura. In caso di apertura forzata l'effrazione è sempre visibile.



## MANIGLIA ERGONOMICA REGOLABILE

Gli armadi con ruote sono forniti con una pratica maniglia ergonomica regolabile che può essere installata in due diverse posizioni. L'altezza della maniglia potrà, quindi, essere impostata a seconda dell'altezza stessa dell'utilizzatore per consentire una movimentazione agile e facile dell'armadio e il mantenimento di una postura ergonomica al fine di ridurre gli sforzi durante il lavoro che potrebbero comportare possibili infortuni.





# MASTER

## COLORI

L'armadio Master è disponibile in 12 combinazioni di colore a cui associare 8 diversi colori per le maniglie per creare soluzioni personalizzate nel minimo dettaglio. È possibile, quindi, assegnare a particolari aree di lavoro o progetti colori specifici oppure implementare il colore aziendale anche negli arredi installati in azienda.

10 colori RAL per la parte metallica  
8 colori per gli accessori plastici

Combinazioni infinite

### MANIGLIA FRONTALE



Dark Grey



Mediterranean Blue



Sky Blue



Glamour Red



Red Carpet



Juicy Orange



Sunny Yellow



Forest Green

### ARMADIO



7016  
7035



7035



5012



9002



7016



7000



5019



9010



6011



3003



5010



5012  
7035

## LEGENDA

### EH

18X27 EH 27X27 EH 36X27 EH 54X27 EH 27X36 EH 36X36 EH 45X36 EH 54X36 EH 64X36 EH 78X36 EH



### Dimensioni armadio

L=	408	561	714	1020	561	714	867	1020	1190	1428
P=	573	573	573	573	726	726	726	726	726	726



### Dimensioni interne cassetto

L=	296	449	602	908	449	602	755	908	1078	1316
P=	449	449	449	449	602	602	602	602	602	602

### PE

Piano estraibile ad estrazione flessibile



### PE

Piano estraibile ad estrazione telescopica



### PR

Piano regolabile



### PF

Piano regolabile fessurato





### Armadio con 3 cassetti 1x50 1x100 1x150

ART.	cassetti		RAL	€
M12A040C01001PD	100-75-50	92-96-100%	7035+7016	558,30
M12A040C0100108	100-75-50	92-96-100%	7035	528,90
M12A040C0100104	100-75-50	92-96-100%	5012	528,90

H=400 mm



### Armadio con 3 cassetti 2x75 1x150

ART.	cassetti		RAL	€
M12A040C01002PD	100-75-50	92-96-100%	7035+7016	545,10
M12A040C0100208	100-75-50	92-96-100%	7035	515,40
M12A040C0100204	100-75-50	92-96-100%	5012	515,40

H=400 mm



### Armadio con 4 cassetti 1x50 2x75 1x100

ART.	cassetti		RAL	€
M12A040C01003PD	100-75-50	92-96-100%	7035+7016	639,00
M12A040C0100308	100-75-50	92-96-100%	7035	594,90
M12A040C0100304	100-75-50	92-96-100%	5012	594,90

H=400 mm



### Armadio con 4 cassetti 2x75 1x150 1x200

ART.	cassetti		RAL	€
M12A060C01020PD	100-75-50	92-96-100%	7035+7016	657,00
M12A060C0102008	100-75-50	92-96-100%	7035	624,00
M12A060C0102004	100-75-50	92-96-100%	5012	624,00

H=600 mm



### Armadio con 3 cassetti 1x100 1x200 1x300

ART.	cassetti		RAL	€
M12A070C01029PD	100-75-50	92-96-100%	7035+7016	613,20
M12A070C0102908	100-75-50	92-96-100%	7035	595,50
M12A070C0102904	100-75-50	92-96-100%	5012	595,50

H=700 mm



### Armadio con 5 cassetti 2x75 3x150

ART.	cassetti		RAL	€
M12A070C01035PD	100-75-50	92-96-100%	7035+7016	757,80
M12A070C0103508	100-75-50	92-96-100%	7035	713,10
M12A070C0103504	100-75-50	92-96-100%	5012	713,10

H=700 mm



### Armadio con ruote con 4 cassetti 2x75 1x150 1x200

ART.	cassetti		RAL	€
M12R060C01020PD	100-75-50	92-96-100%	7035+7016	803,10
M12R060C0102008	100-75-50	92-96-100%	7035	770,10
M12R060C0102004	100-75-50	92-96-100%	5012	770,10

H=822 mm

Ruote: Gomma standard Ø 125 mm  
Portata armadio: 300 kg



### Armadio con ruote con 5 cassetti 1x50 2x75 1x100 1x200

ART.	cassetti		RAL	€
M12R060C01021PD	100-75-50	92-96-100%	7035+7016	897,00
M12R060C0102108	100-75-50	92-96-100%	7035	849,60
M12R060C0102104	100-75-50	92-96-100%	5012	849,60

H=822 mm

Ruote: Gomma standard Ø 125 mm  
Portata armadio: 300 kg



### Armadio con ruote con 6 cassetti 2x50 2x75 1x150 1x200

ART.	cassetti		RAL	€
M12R070C010SSPD	100-75-50	92-96-100%	7035+7016	998,10
M12R070C010SS08	100-75-50	92-96-100%	7035	942,90
M12R070C010SS04	100-75-50	92-96-100%	5012	942,90

H=922 mm

Ruote: Gomma standard Ø 125 mm  
Portata armadio: 300 kg



DIM. INTERNELxP



ESTRAZIONE



PORTATA



RAL 7035 + RAL 7016



RAL 5012



RAL 7035



### Armadio con 2 cassetti 1x100 1x200

ART.	cassetti		RAL	€
M22A040C01004PD	100-75-50	92-96-100%	7035+7016	425,70
M22A040C0100408	100-75-50	92-96-100%	7035	405,90
M22A040C0100404	100-75-50	92-96-100%	5012	405,90

H=400 mm



### Armadio con 3 cassetti 1x50 1x100 1x150

ART.	cassetti		RAL	€
M22A040C01001PD	100-75-50	92-96-100%	7035+7016	501,30
M22A040C0100108	100-75-50	92-96-100%	7035	468,60
M22A040C0100104	100-75-50	92-96-100%	5012	468,60

H=400 mm



### Armadio con 4 cassetti 1x50 2x75 1x100

ART.	cassetti		RAL	€
M22A040C01003PD	100-75-50	92-96-100%	7035+7016	577,50
M22A040C0100308	100-75-50	92-96-100%	7035	527,10
M22A040C0100304	100-75-50	92-96-100%	5012	527,10

H=400 mm



### Armadio con 6 cassetti 1x50 2x75 2x100 1x200

ART.	cassetti		RAL	€
M22A070C01032PD	100-75-50	92-96-100%	7035+7016	787,80
M22A070C0103208	100-75-50	92-96-100%	7035	717,60
M22A070C0103204	100-75-50	92-96-100%	5012	717,60

H=700 mm



### Armadio con 4 cassetti 2x100 1x200 1x300

ART.	cassetti		RAL	€
M22A080C01055PD	100-75-50	92-96-100%	7035+7016	656,40
M22A080C0105508	100-75-50	92-96-100%	7035	621,60
M22A080C0105504	100-75-50	92-96-100%	5012	621,60

H=800 mm



### Armadio con 5 cassetti 1x50 2x100 1x150 1x300

ART.	cassetti		RAL	€
M22A080C01054PD	100-75-50	92-96-100%	7035+7016	732,00
M22A080C0105408	100-75-50	92-96-100%	7035	684,30
M22A080C0105404	100-75-50	92-96-100%	5012	684,30

H=800 mm



### Armadio con 4 cassetti 1x100 1x150 1x200 1x300

ART.	cassetti		RAL	€
M22A085C01092PD	100-75-50	92-96-100%	7035+7016	665,70
M22A085C0109208	100-75-50	92-96-100%	7035	633,30
M22A085C0109204	100-75-50	92-96-100%	5012	633,30

H=850 mm



### Armadio con 5 cassetti 1x100 3x150 1x200

ART.	cassetti		RAL	€
M22A085C01088PD	100-75-50	92-96-100%	7035+7016	741,90
M22A085C0108808	100-75-50	92-96-100%	7035	696,00
M22A085C0108804	100-75-50	92-96-100%	5012	696,00

H=850 mm



### Armadio con 6 cassetti 2x75 2x100 2x200

ART.	cassetti		RAL	€
M22A085C01089PD	100-75-50	92-96-100%	7035+7016	822,60
M22A085C0108908	100-75-50	92-96-100%	7035	756,60
M22A085C0108904	100-75-50	92-96-100%	5012	756,60

H=850 mm



### Armadio con 6 cassetti 1x50 2x100 2x150 1x200

ART.	cassetti		RAL	€
M22A085C01091PD	100-75-50	92-96-100%	7035+7016	822,00
M22A085C0109108	100-75-50	92-96-100%	7035	760,80
M22A085C0109104	100-75-50	92-96-100%	5012	760,80

H=850 mm



DIM. INTERNELxP



ESTRAZIONE



PORTATA



RAL 7035 + RAL 7016



RAL 5012



RAL 7035





### Armadio con 7 cassetti 2x75 3x100 2x150

ART.	cassetti		RAL	€
M22A085C01095PD	100-75-50	92-96-100%	7035+7016	899,70
M22A085C0109508	100-75-50	92-96-100%	7035	822,60
M22A085C0109504	100-75-50	92-96-100%	5012	822,60

H=850 mm



### Armadio con 8 cassetti 1x50 2x75 4x100 1x150

ART.	cassetti		RAL	€
M22A085C01087PD	100-75-50	92-96-100%	7035+7016	979,80
M22A085C0108708	100-75-50	92-96-100%	7035	887,40
M22A085C0108704	100-75-50	92-96-100%	5012	887,40

H=850 mm



### Armadio con ruote con 4 cassetti 2x75 1x150 1x200

ART.	cassetti		RAL	€
M22R060C01020PD	100-75-50	92-96-100%	7035+7016	792,30
M22R060C0102008	100-75-50	92-96-100%	7035	748,50
M22R060C0102004	100-75-50	92-96-100%	5012	748,50

H=822 mm

Ruote: Gomma standard Ø 125 mm  
Portata armadio: 300 kg



### Armadio con ruote con 5 cassetti 1x50 2x75 1x100 1x200

ART.	cassetti		RAL	€
M22R060C01021PD	100-75-50	92-96-100%	7035+7016	872,40
M22R060C0102108	100-75-50	92-96-100%	7035	813,30
M22R060C0102104	100-75-50	92-96-100%	5012	813,30

H=822 mm

Ruote: Gomma standard Ø 125 mm  
Portata armadio: 300 kg



### Armadio con ruote con 6 cassetti 2x50 2x75 1x150 1x200

ART.	cassetti		RAL	€
M22R070C010SSPD	100-75-50	92-96-100%	7035+7016	961,20
M22R070C010SS08	100-75-50	92-96-100%	7035	891,60
M22R070C010SS04	100-75-50	92-96-100%	5012	891,60

H=922 mm

Ruote: Gomma standard Ø 125 mm  
Portata armadio: 300 kg



### Armadio con ruote con 5 cassetti 4x100 1x200

ART.	cassetti		RAL	€
M22R070C010GFPD	100-75-50	92-96-100%	7035+7016	897,00
M22R070C010GF08	100-75-50	92-96-100%	7035	843,90
M22R070C010GF04	100-75-50	92-96-100%	5012	843,90

**H=922 mm**

Ruote: Gomma standard Ø 125 mm  
Portata armadio: 300 kg



### Armadio con ruote con 6 cassetti 1x50 2x75 2x100 1x200

ART.	cassetti		RAL	€
M22R070C01032PD	100-75-50	92-96-100%	7035+7016	967,20
M22R070C0103208	100-75-50	92-96-100%	7035	897,00
M22R070C0103204	100-75-50	92-96-100%	5012	897,00

**H=922 mm**

Ruote: Gomma standard Ø 125 mm  
Portata armadio: 300 kg



### Armadio con ruote con 6 cassetti 2x75 3x100 1x150

ART.	cassetti		RAL	€
M22R070C01044PD	100-75-50	92-96-100%	7035+7016	968,70
M22R070C0104408	100-75-50	92-96-100%	7035	900,30
M22R070C0104404	100-75-50	92-96-100%	5012	900,30

**H=922 mm**

Ruote: Gomma standard Ø 125 mm  
Portata armadio: 300 kg



DIM. INTERNELxP



ESTRAZIONE



PORTATA



RAL 7035 + RAL 7016



RAL 5012



RAL 7035



### Armadio con 5 cassetti 1x50 2x100 1x150 1x200

ART.	cassetti		RAL	€
M32A070C01040PD	100-75-50	92-96-100%	7035+7016	808,50
M32A070C0104008	100-75-50	92-96-100%	7035	748,50
M32A070C0104004	100-75-50	92-96-100%	5012	748,50

H=700 mm



### Armadio con 5 cassetti 2x75 2x100 1x250

ART.	cassetti		RAL	€
M32A070C01042PD	100-75-50	92-96-100%	7035+7016	810,60
M32A070C0104208	100-75-50	92-96-100%	7035	741,90
M32A070C0104204	100-75-50	92-96-100%	5012	741,90

H=700 mm



### Armadio con 6 cassetti 2x75 3x100 1x150

ART.	cassetti		RAL	€
M32A070C01044PD	100-75-50	92-96-100%	7035+7016	885,30
M32A070C0104408	100-75-50	92-96-100%	7035	807,30
M32A070C0104404	100-75-50	92-96-100%	5012	807,30

H=700 mm



### Armadio con 7 cassetti 1x50 2x75 2x100 1x150 1x200

ART.	cassetti		RAL	€
M32A085C010AEPD	100-75-50	92-96-100%	7035+7016	996,30
M32A085C010AE08	100-75-50	92-96-100%	7035	908,10
M32A085C010AE04	100-75-50	92-96-100%	5012	908,10

H=850 mm



### Armadio con 7 cassetti 2x75 2x100 2x125 1x150

ART.	cassetti		RAL	€
M32A085C010ACPD	100-75-50	92-96-100%	7035+7016	994,80
M32A085C010AC08	100-75-50	92-96-100%	7035	905,70
M32A085C010AC04	100-75-50	92-96-100%	5012	905,70

H=850 mm



### Armadio con 8 cassetti 4x75 3x100 1x150

ART.	cassetti		RAL	€
M32A085C010AGPD	100-75-50	92-96-100%	7035+7016	1073,10
M32A085C010AG08	100-75-50	92-96-100%	7035	966,90
M32A085C010AG04	100-75-50	92-96-100%	5012	966,90

H=850 mm



### Armadio con 7 cassetti 1x50 2x75 2x100 1x200 1x300

ART.	cassetti		RAL	€
M32A100C010BNPD	100-75-50	92-96-100%	7035+7016	1034,70
M32A100C010BN08	100-75-50	92-96-100%	7035	942,00
M32A100C010BN04	100-75-50	92-96-100%	5012	942,00

H=1000 mm



### Armadio con 7 cassetti 2x75 1x100 3x150 1x200

ART.	cassetti		RAL	€
M32A100C010AWPD	100-75-50	92-96-100%	7035+7016	1017,30
M32A100C010AW08	100-75-50	92-96-100%	7035	938,10
M32A100C010AW04	100-75-50	92-96-100%	5012	938,10

H=1000 mm



### Armadio con 8 cassetti 1x50 2x75 3x100 1x150 1x250

ART.	cassetti		RAL	€
M32A100C010BQPD	100-75-50	92-96-100%	7035+7016	1116,00
M32A100C010BQ08	100-75-50	92-96-100%	7035	1010,40
M32A100C010BQ04	100-75-50	92-96-100%	5012	1010,40

H=1000 mm



DIM. INTERNELxP



ESTRAZIONE



PORTATA



RAL 7035 + RAL 7016



RAL 5012



RAL 7035



### Armadio con porte con 1 cassetto 1x75 2xPE



ART.	cassetti / piani estraibili		RAL	€
M32A100C010BUPD	100-75-50	92-96-100%	7035+7016	800,40
M32A100C010BU08	100-75-50	92-96-100%	7035	800,40
M32A100C010BU04	100-75-50	92-96-100%	5012	800,40
M32A100C010BVPD	200	100%	7035+7016	890,40
M32A100C010BV08	200	100%	7035	890,40
M32A100C010BV04	200	100%	5012	890,40

H=1022 mm

### Armadio con porte con 2 cassetti 2x75 1xPE



ART.	cassetti / piani estraibili		RAL	€
M32A100C010BWPD	100-75-50	92-96-100%	7035+7016	780,90
M32A100C010BW08	100-75-50	92-96-100%	7035	780,90
M32A100C010BW04	100-75-50	92-96-100%	5012	780,90
M32A100C010BXP	200	100%	7035+7016	870,90
M32A100C010BX08	200	100%	7035	870,90
M32A100C010BX04	200	100%	5012	870,90

H=1022 mm

### Armadio con porte con 3 cassetti 3x75 1xPE



ART.	cassetti / piani estraibili		RAL	€
M32A100C010BYPD	100-75-50	92-96-100%	7035+7016	856,20
M32A100C010BY08	100-75-50	92-96-100%	7035	856,20
M32A100C010BY04	100-75-50	92-96-100%	5012	856,20
M32A100C010BZPD	200	100%	7035+7016	976,20
M32A100C010BZ08	200	100%	7035	976,20
M32A100C010BZ04	200	100%	5012	976,20

H=1022 mm

### Armadio con porte con 3 cassetti 3x75 2xPE



ART.	cassetti / piani estraibili		RAL	€
M32A100C010CAPD	100-75-50	92-96-100%	7035+7016	951,00
M32A100C010CA08	100-75-50	92-96-100%	7035	951,00
M32A100C010CA04	100-75-50	92-96-100%	5012	951,00
M32A100C010CBPD	200	100%	7035+7016	1101,00
M32A100C010CB08	200	100%	7035	1101,00
M32A100C010CB04	200	100%	5012	1101,00

H=1022 mm





### Armadio con porte con 4 cassetti 4x75

ART.	cassetti		RAL	€
M32A100C010CCPD	100-75-50	92-96-100%	7035+7016	836,70
M32A100C010CC08	100-75-50	92-96-100%	7035	836,70
M32A100C010CC04	100-75-50	92-96-100%	5012	836,70
M32A100C010CDPD	200	100%	7035+7016	956,70
M32A100C010CD08	200	100%	7035	956,70
M32A100C010CD04	200	100%	5012	956,70

H=1022 mm



### Armadio con porte con 5 cassetti 5x75

ART.	cassetti		RAL	€
M32A100C010CEPD	100-75-50	92-96-100%	7035+7016	912,00
M32A100C010CE08	100-75-50	92-96-100%	7035	912,00
M32A100C010CE04	100-75-50	92-96-100%	5012	912,00
M32A100C010CFPD	200	100%	7035+7016	1062,00
M32A100C010CF08	200	100%	7035	1062,00
M32A100C010CF04	200	100%	5012	1062,00

H=1022 mm



### Armadio con porte scorrevoli con 2 cassetti 2x75 6xPE

ART.	cassetti / piani estraibili		RAL	€
M32D100C010GWPD	100-75-50	92-96-100%	7035+7016	1963,20
M32D100C010GW08	100-75-50	92-96-100%	7035	1963,20
M32D100C010GW04	100-75-50	92-96-100%	5012	1963,20
M32D100C010GXPD	200	100%	7035+7016	2203,20
M32D100C010GX08	200	100%	7035	2203,20
M32D100C010GX04	200	100%	5012	2203,20

H=1022 mm



### Armadio con porte scorrevoli con 4 cassetti 4x75 2xPE

ART.	cassetti / piani estraibili		RAL	€
M32D100C010GYPD	100-75-50	92-96-100%	7035+7016	1734,60
M32D100C010GY08	100-75-50	92-96-100%	7035	1734,60
M32D100C010GY04	100-75-50	92-96-100%	5012	1734,60
M32D100C010GZPD	200	100%	7035+7016	1914,60
M32D100C010GZ08	200	100%	7035	1914,60
M32D100C010GZ04	200	100%	5012	1914,60

H=1022 mm





### Armadio con porte scorrevoli con 6 cassetti 6x75 2xPE



ART.	cassetti / piani estraibili		RAL	€
M32D100C010HAPD	100-75-50	92-96-100%	7035+7016	1885,20
M32D100C010HA08	100-75-50	92-96-100%	7035	1885,20
M32D100C010HA04	100-75-50	92-96-100%	5012	1885,20
M32D100C010HBPD	200	100%	7035+7016	2125,20
M32D100C010HB08	200	100%	7035	2125,20
M32D100C010HB04	200	100%	5012	2125,20

H=1022 mm

### Armadio con porte scorrevoli con 8 cassetti 8x75



ART.	cassetti		RAL	€
M32D100C010HNPD	100-75-50	92-96-100%	7035+7016	1846,20
M32D100C010HN08	100-75-50	92-96-100%	7035	1846,20
M32D100C010HN04	100-75-50	92-96-100%	5012	1846,20
M32D100C010HPPD	200	100%	7035+7016	2086,20
M32D100C010HP08	200	100%	7035	2086,20
M32D100C010HP04	200	100%	5012	2086,20

H=1022 mm

### Armadio con porte scorrevoli con 4 cassetti 4x75 4xPE



ART.	cassetti / piani estraibili		RAL	€
M32D100C010HEPD	100-75-50	92-96-100%	7035+7016	1924,20
M32D100C010HE08	100-75-50	92-96-100%	7035	1924,20
M32D100C010HE04	100-75-50	92-96-100%	5012	1924,20
M32D100C010HFDP	200	100%	7035+7016	2164,20
M32D100C010HF08	200	100%	7035	2164,20
M32D100C010HF04	200	100%	5012	2164,20

H=1022 mm

### Armadio con porte scorrevoli con 10 cassetti 10x75



ART.	cassetti		RAL	€
M32D100C010HJPD	100-75-50	92-96-100%	7035+7016	1996,80
M32D100C010HJ08	100-75-50	92-96-100%	7035	1996,80
M32D100C010HJ04	100-75-50	92-96-100%	5012	1996,80
M32D100C010HKPD	200	100%	7035+7016	2296,80
M32D100C010HK08	200	100%	7035	2296,80
M32D100C010HK04	200	100%	5012	2296,80

H=1022 mm



### Armadio con 7 cassetti 2xPR 2x75 1x100 3x150 1x200

ART.	cassetti		RAL	€
M32A200C010FSPD	100-75-50	92-96-100%	7035+7016	1376,10
M32A200C010FS08	100-75-50	92-96-100%	7035	1296,90
M32A200C010FS04	100-75-50	92-96-100%	5012	1296,90
M32A200C010FTPD	200	100%	7035+7016	1586,10
M32A200C010FT08	200	100%	7035	1506,90
M32A200C010FT04	200	100%	5012	1506,90

H=2000 mm



### Armadio con porte con 3 cassetti 2xPR 2x100 1x150 2xPE

ART.	cassetti / piani estraibili		RAL	€
M32A200C010FWPD	100-75-50	92-96-100%	7035+7016	1344,00
M32A200C010FW08	100-75-50	92-96-100%	7035	1344,00
M32A200C010FW04	100-75-50	92-96-100%	5012	1344,00
M32A200C010FXPD	200	100%	7035+7016	1494,00
M32A200C010FX08	200	100%	7035	1494,00
M32A200C010FX04	200	100%	5012	1494,00

H=2000 mm



### Armadio con porte con 7 cassetti 3xPR 2x75 1x100 3x150 1x200

ART.	cassetti		RAL	€
M32A200C010FYPD	100-75-50	92-96-100%	7035+7016	1665,00
M32A200C010FY08	100-75-50	92-96-100%	7035	1585,80
M32A200C010FY04	100-75-50	92-96-100%	5012	1585,80
M32A200C010FZPD	200	100%	7035+7016	1875,00
M32A200C010FZ08	200	100%	7035	1795,80
M32A200C010FZ04	200	100%	5012	1795,80

H=2000 mm





### Armadio con ruote con 5 cassetti 1x50 2x100 1x150 1x200

ART.	cassetti		RAL	€
M32R070C01040PD	100-75-50	92-96-100%	7035+7016	993,90
M32R070C0104008	100-75-50	92-96-100%	7035	933,90
M32R070C0104004	100-75-50	92-96-100%	5012	933,90

**H=922 mm**

Ruote: Gomma standard Ø 125 mm  
Portata armadio: 300 kg



### Armadio con ruote con 5 cassetti 2x75 2x100 1x250

ART.	cassetti		RAL	€
M32R070C01042PD	100-75-50	92-96-100%	7035+7016	996,00
M32R070C0104208	100-75-50	92-96-100%	7035	927,30
M32R070C0104204	100-75-50	92-96-100%	5012	927,30

**H=922 mm**

Ruote: Gomma standard Ø 125 mm  
Portata armadio: 300 kg



### Armadio con ruote con 6 cassetti 2x75 3x100 1x150

ART.	cassetti		RAL	€
M32R070C01044PD	100-75-50	92-96-100%	7035+7016	1070,70
M32R070C0104408	100-75-50	92-96-100%	7035	992,70
M32R070C0104404	100-75-50	92-96-100%	5012	992,70

**H=922 mm**

Ruote: Gomma standard Ø 125 mm  
Portata armadio: 300 kg



#### Cassetto H 50 mm

Set composto da 12 divisori a 4 canali e 65 divisori trasversali 36 mm



#### Cassetto H 75 mm

Set di predisposizione per termoformati



#### Cassetto H 200 mm

Set composto da 2 divisori longitudinali fessurati 455 mm e 3 divisori trasversali 200 mm



#### Cassetto H 300 mm

Set composto da 1 divisorio longitudinale fessurato 455 mm

Utensili e termoformati esclusi



DIM. INTERNELxP



ESTRAZIONE



PORTATA



RAL 7035 + RAL 7016



RAL 5012



RAL 7035





### Armadio con 5 cassetti 3x100 1x150 1x300



ART.	cassetti		RAL	€
	KG			
M52A085C010AKPD	100-75-50	92-96-100%	7035+7016	983,40
M52A085C010AK08	100-75-50	92-96-100%	7035	926,70
M52A085C010AK04	100-75-50	92-96-100%	5012	926,70
M52A085C010ALPD	200	100%	7035+7016	1133,40
M52A085C010AL08	200	100%	7035	1076,70
M52A085C010AL04	200	100%	5012	1076,70

H=850 mm

### Armadio con 6 cassetti 2x75 2x100 1x150 1x250



ART.	cassetti		RAL	€
	KG			
M52A085C010AMPD	100-75-50	92-96-100%	7035+7016	1076,10
M52A085C010AM08	100-75-50	92-96-100%	7035	1001,40
M52A085C010AM04	100-75-50	92-96-100%	5012	1001,40
M52A085C010ANPD	200	100%	7035+7016	1256,10
M52A085C010AN08	200	100%	7035	1181,40
M52A085C010AN04	200	100%	5012	1181,40

H=850 mm

### Armadio con 7 cassetti 1x50 2x75 2x100 1x150 1x200



ART.	cassetti		RAL	€
	KG			
M52A085C010AEPD	100-75-50	92-96-100%	7035+7016	1177,80
M52A085C010AE08	100-75-50	92-96-100%	7035	1085,10
M52A085C010AE04	100-75-50	92-96-100%	5012	1085,10
M52A085C010AFPDP	200	100%	7035+7016	1357,80
M52A085C010AF08	200	100%	7035	1265,10
M52A085C010AF04	200	100%	5012	1265,10

H=850 mm I cassetti H=50 mm hanno sempre estrazione flessibile

### Armadio con 6 cassetti 3x100 2x150 1x300



ART.	cassetti		RAL	€
	KG			
M52A100C010CQPD	100-75-50	92-96-100%	7035+7016	1129,80
M52A100C010CQ08	100-75-50	92-96-100%	7035	1062,60
M52A100C010CQ04	100-75-50	92-96-100%	5012	1062,60
M52A100C010CRPD	200	100%	7035+7016	1309,80
M52A100C010CR08	200	100%	7035	1242,60
M52A100C010CR04	200	100%	5012	1242,60

H=1000 mm



### Armadio con 7 cassetti 2x75 1x100 3x150 1x200

ART.	cassetti		RAL	€
M52A100C010AWPD	100-75-50	92-96-100%	7035+7016	1224,30
M52A100C010AW08	100-75-50	92-96-100%	7035	1140,00
M52A100C010AW04	100-75-50	92-96-100%	5012	1140,00
M52A100C010BHPD	200	100%	7035+7016	1434,30
M52A100C010BH08	200	100%	7035	1350,00
M52A100C010BH04	200	100%	5012	1350,00

H=1000 mm



### Armadio con 8 cassetti 2x75 4x100 1x150 1x200

ART.	cassetti		RAL	€
M52A100C010CNPD	100-75-50	92-96-100%	7035+7016	1324,80
M52A100C010CN08	100-75-50	92-96-100%	7035	1223,70
M52A100C010CN04	100-75-50	92-96-100%	5012	1223,70
M52A100C010CPPD	200	100%	7035+7016	1564,80
M52A100C010CP08	200	100%	7035	1463,70
M52A100C010CP04	200	100%	5012	1463,70

H=1000 mm



### Armadio con 9 cassetti 2x75 2x100 1x150 3x200 1x300

ART.	cassetti		RAL	€
M52A150C010FLPD	100-75-50	92-96-100%	7035+7016	1600,80
M52A150C010FL08	100-75-50	92-96-100%	7035	1497,30
M52A150C010FL04	100-75-50	92-96-100%	5012	1497,30
M52A150C010FMPD	200	100%	7035+7016	1870,80
M52A150C010FM08	200	100%	7035	1767,30
M52A150C010FM04	200	100%	5012	1767,30

H=1500 mm



### Armadio con 10 cassetti 2x75 3x100 1x150 4x200

ART.	cassetti		RAL	€
M52A150C010FNPD	100-75-50	92-96-100%	7035+7016	1705,50
M52A150C010FN08	100-75-50	92-96-100%	7035	1588,20
M52A150C010FN04	100-75-50	92-96-100%	5012	1588,20
M52A150C010FPPD	200	100%	7035+7016	2005,50
M52A150C010FP08	200	100%	7035	1888,20
M52A150C010FP04	200	100%	5012	1888,20

H=1500 mm



DIM. INTERNELxP



ESTRAZIONE



PORTATA



RAL 7035 + RAL 7016



RAL 5012



RAL 7035



### Armadio con 11 cassetti 2x75 4x100 3x150 2x200

ART.	cassetti		RAL	€
M52A150C010FQPD	100-75-50	92-96-100%	7035+7016	1808,40
M52A150C010FQ08	100-75-50	92-96-100%	7035	1676,70
M52A150C010FQ04	100-75-50	92-96-100%	5012	1676,70
M52A150C010FRPD	200	100%	7035+7016	2138,40
M52A150C010FR08	200	100%	7035	2006,70
M52A150C010FR04	200	100%	5012	2006,70

H=1500 mm



### Armadio con 7 cassetti 2xPR 2x75 1x100 3x150 1x200

ART.	cassetti		RAL	€
M52A200C010FSPD	100-75-50	92-96-100%	7035+7016	1615,50
M52A200C010FS08	100-75-50	92-96-100%	7035	1531,20
M52A200C010FS04	100-75-50	92-96-100%	5012	1531,20
M52A200C010FTPD	200	100%	7035+7016	1825,50
M52A200C010FT08	200	100%	7035	1741,20
M52A200C010FT04	200	100%	5012	1741,20

H=2000 mm



### Armadio con porte con 3 cassetti 2xPR 2x100 1x150 2xPE

ART.	cassetti / piani estraibili		RAL	€
M52A200C010FWPD	100-75-50	92-96-100%	7035+7016	1540,20
M52A200C010FW08	100-75-50	92-96-100%	7035	1540,20
M52A200C010FW04	100-75-50	92-96-100%	5012	1540,20
M52A200C010FXPD	200	100%	7035+7016	1690,20
M52A200C010FX08	200	100%	7035	1690,20
M52A200C010FX04	200	100%	5012	1690,20

H=2000 mm



### Armadio con porte con 7 cassetti 3xPR 2x75 1x100 3x150 1x200

ART.	cassetti		RAL	€
M52A200C010FYPD	100-75-50	92-96-100%	7035+7016	1949,40
M52A200C010FY08	100-75-50	92-96-100%	7035	1865,10
M52A200C010FY04	100-75-50	92-96-100%	5012	1865,10
M52A200C010FZPD	200	100%	7035+7016	2159,40
M52A200C010FZ08	200	100%	7035	2075,10
M52A200C010FZ04	200	100%	5012	2075,10

H=2000 mm



### Armadio con ruote con 4 cassetti 1x100 2x150 1x200

ART.	cassetti		RAL	€
M52R070C01049PD	100-75-50	92-96-100%	7035+7016	1119,60
M52R070C0104908	100-75-50	92-96-100%	7035	1076,40
M52R070C0104904	100-75-50	92-96-100%	5012	1076,40

H=922 mm

Ruote: Gomma elastica Ø 125 mm  
Portata armadio: 750 kg



### Armadio con ruote con 5 cassetti 2x75 1x100 1x150 1x200

ART.	cassetti		RAL	€
M52R070C01031PD	100-75-50	92-96-100%	7035+7016	1209,90
M52R070C0103108	100-75-50	92-96-100%	7035	1146,60
M52R070C0103104	100-75-50	92-96-100%	5012	1146,60

H=922 mm

Ruote: Gomma elastica Ø 125 mm  
Portata armadio: 750 kg



### Armadio con ruote con 6 cassetti 2x75 3x100 1x150

ART.	cassetti		RAL	€
M52R070C01044PD	100-75-50	92-96-100%	7035+7016	1311,60
M52R070C0104408	100-75-50	92-96-100%	7035	1232,70
M52R070C0104404	100-75-50	92-96-100%	5012	1232,70

H=922 mm

Ruote: Gomma elastica Ø 125 mm  
Portata armadio: 750 kg





### Armadio con 1 cassetto 1x100

ART.	cassetti		RAL	€
M23A020C01005PD	100-75-50	92-96-100%	7035+7016	264,90
M23A020C0100508	100-75-50	92-96-100%	7035	254,40
M23A020C0100504	100-75-50	92-96-100%	5012	254,40

H=200 mm



### Armadio con 1 cassetto 1x200

ART.	cassetti		RAL	€
M23A030C01006PD	100-75-50	92-96-100%	7035+7016	278,70
M23A030C0100608	100-75-50	92-96-100%	7035	274,80
M23A030C0100604	100-75-50	92-96-100%	5012	274,80

H=300 mm



### Armadio con 3 cassetti 1x50 1x100 1x150

ART.	cassetti		RAL	€
M23A040C01001PD	100-75-50	92-96-100%	7035+7016	509,70
M23A040C0100108	100-75-50	92-96-100%	7035	479,10
M23A040C0100104	100-75-50	92-96-100%	5012	479,10

H=400 mm



### Armadio con 3 cassetti 2x75 1x150

ART.	cassetti		RAL	€
M23A040C01002PD	100-75-50	92-96-100%	7035+7016	502,50
M23A040C0100208	100-75-50	92-96-100%	7035	474,00
M23A040C0100204	100-75-50	92-96-100%	5012	474,00

H=400 mm



### Armadio con 4 cassetti 2x75 1x150 1x200

ART.	cassetti		RAL	€
M23A060C01020PD	100-75-50	92-96-100%	7035+7016	599,40
M23A060C0102008	100-75-50	92-96-100%	7035	567,00
M23A060C0102004	100-75-50	92-96-100%	5012	567,00

H=600 mm





### Armadio con 5 cassetti 1x50 2x75 1x100 1x200

ART.	cassetti		RAL	€
M23A060C01021PD	100-75-50	92-96-100%	7035+7016	675,60
M23A060C0102108	100-75-50	92-96-100%	7035	628,80
M23A060C0102104	100-75-50	92-96-100%	5012	628,80

H=600 mm



### Armadio con 5 cassetti 2x75 1x100 1x150 1x200

ART.	cassetti		RAL	€
M23A070C01031PD	100-75-50	92-96-100%	7035+7016	699,60
M23A070C0103108	100-75-50	92-96-100%	7035	656,70
M23A070C0103104	100-75-50	92-96-100%	5012	656,70

H=700 mm



### Armadio con 4 cassetti 1x100 2x150 1x200

ART.	cassetti		RAL	€
M23A070C01049PD	100-75-50	92-96-100%	7035+7016	630,60
M23A070C0104908	100-75-50	92-96-100%	7035	600,00
M23A070C0104904	100-75-50	92-96-100%	5012	600,00

H=700 mm



### Armadio con 6 cassetti 1x50 2x75 2x100 1x200

ART.	cassetti		RAL	€
M23A070C01032PD	100-75-50	92-96-100%	7035+7016	775,80
M23A070C0103208	100-75-50	92-96-100%	7035	718,50
M23A070C0103204	100-75-50	92-96-100%	5012	718,50

H=700 mm



### Armadio con 4 cassetti 2x100 1x200 1x300

ART.	cassetti		RAL	€
M23A080C01055PD	100-75-50	92-96-100%	7035+7016	654,30
M23A080C0105508	100-75-50	92-96-100%	7035	622,20
M23A080C0105504	100-75-50	92-96-100%	5012	622,20

H=800 mm



DIM. INTERNELxP



ESTRAZIONE



PORTATA



RAL 7035 + RAL 7016



RAL 5012



RAL 7035



### Armadio con 5 cassetti 1x50 2x100 1x150 1x300

ART.	cassetti		RAL	€
M23A080C01054PD	100-75-50	92-96-100%	7035+7016	725,10
M23A080C0105408	100-75-50	92-96-100%	7035	676,80
M23A080C0105404	100-75-50	92-96-100%	5012	676,80

H=800 mm



### Armadio con 6 cassetti 2x75 2x100 1x150 1x200

ART.	cassetti		RAL	€
M23A080C01056PD	100-75-50	92-96-100%	7035+7016	791,70
M23A080C0105608	100-75-50	92-96-100%	7035	738,30
M23A080C0105604	100-75-50	92-96-100%	5012	738,30

H=800 mm



### Armadio con 7 cassetti 1x50 2x75 2x100 2x150

ART.	cassetti		RAL	€
M23A080C01066PD	100-75-50	92-96-100%	7035+7016	862,50
M23A080C0106608	100-75-50	92-96-100%	7035	792,90
M23A080C0106604	100-75-50	92-96-100%	5012	792,90

H=800 mm



### Armadio con 7 cassetti 2x75 4x100 1x150

ART.	cassetti		RAL	€
M23A080C01065PD	100-75-50	92-96-100%	7035+7016	868,80
M23A080C0106508	100-75-50	92-96-100%	7035	798,30
M23A080C0106504	100-75-50	92-96-100%	5012	798,30

H=800 mm



### Armadio con porta con 1 cassetto 1x75 1xPR 1xPE

ART.	cassetti / piani estraibili		RAL	€
M23A080C01069PD	100-75-50	92-96-100%	7035+7016	622,50
M23A080C0106908	100-75-50	92-96-100%	7035	612,30
M23A080C0106904	100-75-50	92-96-100%	5012	612,30

H=800 mm



### Armadio con 4 cassetti 3x150 1x300

ART.	cassetti		RAL	€
M23A085C010AQPDP	100-75-50	92-96-100%	7035+7016	660,30
M23A085C010AQ08	100-75-50	92-96-100%	7035	628,80
M23A085C010AQ04	100-75-50	92-96-100%	5012	628,80

H=850 mm



### Armadio con 5 cassetti 1x50 2x100 1x200 1x300

ART.	cassetti		RAL	€
M23A085C01093PD	100-75-50	92-96-100%	7035+7016	741,90
M23A085C0109308	100-75-50	92-96-100%	7035	697,80
M23A085C0109304	100-75-50	92-96-100%	5012	697,80

H=850 mm



### Armadio con 5 cassetti 2x100 1x150 2x200

ART.	cassetti		RAL	€
M23A085C01090PD	100-75-50	92-96-100%	7035+7016	739,50
M23A085C0109008	100-75-50	92-96-100%	7035	702,60
M23A085C0109004	100-75-50	92-96-100%	5012	702,60

H=850 mm



### Armadio con 6 cassetti 1x75 3x100 1x125 1x250

ART.	cassetti		RAL	€
M23A085C01094PD	100-75-50	92-96-100%	7035+7016	813,60
M23A085C0109408	100-75-50	92-96-100%	7035	757,80
M23A085C0109404	100-75-50	92-96-100%	5012	757,80

H=850 mm



### Armadio con 6 cassetti 1x50 2x100 2x150 1x200

ART.	cassetti		RAL	€
M23A085C01091PD	100-75-50	92-96-100%	7035+7016	810,30
M23A085C0109108	100-75-50	92-96-100%	7035	757,20
M23A085C0109104	100-75-50	92-96-100%	5012	757,20

H=850 mm





### Armadio con 7 cassetti 1x50 2x75 2x100 1x150 1x200

ART.	cassetti		RAL	€
M23A085C010AEPD	100-75-50	92-96-100%	7035+7016	879,30
M23A085C010AE08	100-75-50	92-96-100%	7035	813,90
M23A085C010AE04	100-75-50	92-96-100%	5012	813,90

H=850 mm



### Armadio con 7 cassetti 2x75 3x100 2x150

ART.	cassetti		RAL	€
M23A085C01095PD	100-75-50	92-96-100%	7035+7016	880,20
M23A085C0109508	100-75-50	92-96-100%	7035	812,10
M23A085C0109504	100-75-50	92-96-100%	5012	812,10

H=850 mm



### Armadio con 8 cassetti 1x50 2x75 4x100 1x150

ART.	cassetti		RAL	€
M23A085C01087PD	100-75-50	92-96-100%	7035+7016	956,40
M23A085C0108708	100-75-50	92-96-100%	7035	873,90
M23A085C0108704	100-75-50	92-96-100%	5012	873,90

H=850 mm



### Armadio con ruote con 4 cassetti 2x75 1x150 1x200

ART.	cassetti		RAL	€
M23R060C01020PD	100-75-50	92-96-100%	7035+7016	786,00
M23R060C0102008	100-75-50	92-96-100%	7035	753,60
M23R060C0102004	100-75-50	92-96-100%	5012	753,60

H=822 mm

Ruote: Gomma standard Ø 125 mm  
Portata armadio: 300 kg



### Armadio con ruote con 5 cassetti 1x50 2x75 1x100 1x200

ART.	cassetti		RAL	€
M23R060C01021PD	100-75-50	92-96-100%	7035+7016	862,20
M23R060C0102108	100-75-50	92-96-100%	7035	815,40
M23R060C0102104	100-75-50	92-96-100%	5012	815,40

H=822 mm

Ruote: Gomma standard Ø 125 mm  
Portata armadio: 300 kg



### Armadio con ruote con 6 cassetti 4x75 2x100

ART.	cassetti		RAL	€
M23R060C01022PD	100-75-50	92-96-100%	7035+7016	932,10
M23R060C0102208	100-75-50	92-96-100%	7035	870,30
M23R060C0102204	100-75-50	92-96-100%	5012	870,30

**H=822 mm**

Ruote: Gomma standard Ø 125 mm  
Portata armadio: 300 kg



### Armadio con ruote con 5 cassetti 2x75 1x100 1x150 1x200

ART.	cassetti		RAL	€
M23R070C01031PD	100-75-50	92-96-100%	7035+7016	879,00
M23R070C0103108	100-75-50	92-96-100%	7035	836,10
M23R070C0103104	100-75-50	92-96-100%	5012	836,10

**H=922 mm**

Ruote: Gomma standard Ø 125 mm  
Portata armadio: 300 kg



### Armadio con ruote con 6 cassetti 1x50 2x75 2x100 1x200

ART.	cassetti		RAL	€
M23R070C01032PD	100-75-50	92-96-100%	7035+7016	955,20
M23R070C0103208	100-75-50	92-96-100%	7035	897,90
M23R070C0103204	100-75-50	92-96-100%	5012	897,90

**H=922 mm**

Ruote: Gomma standard Ø 125 mm  
Portata armadio: 300 kg



### Armadio con ruote con 5 cassetti 1x50 2x100 1x150 1x300

ART.	cassetti		RAL	€
M23R080C01054PD	100-75-50	92-96-100%	7035+7016	897,90
M23R080C0105408	100-75-50	92-96-100%	7035	849,60
M23R080C0105404	100-75-50	92-96-100%	5012	849,60

**H=1022 mm**

Ruote: Gomma standard Ø 125 mm  
Portata armadio: 300 kg



### Armadio con ruote con 5 cassetti 3x100 2x200

ART.	cassetti		RAL	€
M23R080C01063PD	100-75-50	92-96-100%	7035+7016	900,90
M23R080C0106308	100-75-50	92-96-100%	7035	861,60
M23R080C0106304	100-75-50	92-96-100%	5012	861,60

**H=1022 mm**

Ruote: Gomma standard Ø 125 mm  
Portata armadio: 300 kg



DIM. INTERNELxP



ESTRAZIONE



PORTATA



RAL 7035 + RAL 7016



RAL 5012



RAL 7035



### Armadio con ruote con 7 cassetti 2x75 4x100 1x150

ART.	cassetti		RAL	€
M23R080C01065PD	100-75-50	92-96-100%	7035+7016	1041,60
M23R080C0106508	100-75-50	92-96-100%	7035	971,10
M23R080C0106504	100-75-50	92-96-100%	5012	971,10

**H=1022 mm**

Ruote: Gomma standard Ø 125 mm  
Portata armadio: 300 kg



### Armadio con ruote con 7 cassetti 1x50 2x75 2x100 2x150

ART.	cassetti		RAL	€
M23R080C01066PD	100-75-50	92-96-100%	7035+7016	1035,30
M23R080C0106608	100-75-50	92-96-100%	7035	965,70
M23R080C0106604	100-75-50	92-96-100%	5012	965,70

**H=1022 mm**

Ruote: Gomma standard Ø 125 mm  
Portata armadio: 300 kg







Utensili e termoformati esclusi



**Cassetto H 50 mm**  
Set composto da 12 divisori a 4 canali e 65 divisori trasversali 36 mm



**Cassetto H 75 mm**  
Set di predisposizione per termoformati



**Cassetto H 150 mm**  
Set composto da 2 divisori longitudinali fessurati 610 mm e 3 divisori trasversali 149 mm



DIM. INTERNELxP



ESTRAZIONE



PORTATA



RAL 7035 + RAL 7016



RAL 5012



RAL 7035



### Armadio con 4 cassetti 1x100 2x150 1x300



ART.	cassetti		RAL	€
M33A080C01072PD	100-75-50	92-96-100%	7035+7016	768,30
M33A080C0107208	100-75-50	92-96-100%	7035	724,50
M33A080C0107204	100-75-50	92-96-100%	5012	724,50

H=800 mm

### Armadio con 6 cassetti 2x75 2x100 1x150 1x200



ART.	cassetti		RAL	€
M33A080C01056PD	100-75-50	92-96-100%	7035+7016	935,40
M33A080C0105608	100-75-50	92-96-100%	7035	866,40
M33A080C0105604	100-75-50	92-96-100%	5012	866,40

H=800 mm

### Armadio con 4 cassetti 1x100 1x150 1x200 1x300



ART.	cassetti		RAL	€
M33A085C01092PD	100-75-50	92-96-100%	7035+7016	741,60
M33A085C0109208	100-75-50	92-96-100%	7035	694,20
M33A085C0109204	100-75-50	92-96-100%	5012	694,20
M33A085C010ASPD	200	100%	7035+7016	861,60
M33A085C010AS08	200	100%	7035	814,20
M33A085C010AS04	200	100%	5012	814,20

H=850 mm

### Armadio con 5 cassetti 1x50 2x100 1x200 1x300



ART.	cassetti		RAL	€
M33A085C01093PD	100-75-50	92-96-100%	7035+7016	827,70
M33A085C0109308	100-75-50	92-96-100%	7035	764,40
M33A085C0109304	100-75-50	92-96-100%	5012	764,40
M33A085C010ATPD	200	100%	7035+7016	947,70
M33A085C010AT08	200	100%	7035	884,40
M33A085C010AT04	200	100%	5012	884,40

H=850 mm I cassetti H=50 mm hanno sempre estrazione flessibile



### Armadio con 5 cassetti 1x100 3x150 1x200

ART.	cassetti		RAL	€
M33A085C01088PD	100-75-50	92-96-100%	7035+7016	818,10
M33A085C0108808	100-75-50	92-96-100%	7035	765,60
M33A085C0108804	100-75-50	92-96-100%	5012	765,60
M33A085C010APPD	200	100%	7035+7016	968,10
M33A085C010AP08	200	100%	7035	915,60
M33A085C010AP04	200	100%	5012	915,60

H=850 mm



### Armadio con 7 cassetti 1x50 2x75 2x100 1x150 1x200

ART.	cassetti		RAL	€
M33A085C010AEPD	100-75-50	92-96-100%	7035+7016	987,90
M33A085C010AE08	100-75-50	92-96-100%	7035	905,40
M33A085C010AE04	100-75-50	92-96-100%	5012	905,40
M33A085C010AFPD	200	100%	7035+7016	1167,90
M33A085C010AF08	200	100%	7035	1085,40
M33A085C010AF04	200	100%	5012	1085,40

H=850 mm I cassetti H=50 mm hanno sempre estrazione flessibile



### Armadio con 7 cassetti 2x75 3x100 2x150

ART.	cassetti		RAL	€
M33A085C01095PD	100-75-50	92-96-100%	7035+7016	981,00
M33A085C0109508	100-75-50	92-96-100%	7035	903,90
M33A085C0109504	100-75-50	92-96-100%	5012	903,90
M33A085C010AUPD	200	100%	7035+7016	1191,00
M33A085C010AU08	200	100%	7035	1113,90
M33A085C010AU04	200	100%	5012	1113,90

H=850 mm



### Armadio con 8 cassetti 1x50 2x75 4x100 1x150

ART.	cassetti		RAL	€
M33A085C01087PD	100-75-50	92-96-100%	7035+7016	1067,10
M33A085C0108708	100-75-50	92-96-100%	7035	974,10
M33A085C0108704	100-75-50	92-96-100%	5012	974,10
M33A085C010AVPD	200	100%	7035+7016	1277,10
M33A085C010AV08	200	100%	7035	1184,10
M33A085C010AV04	200	100%	5012	1184,10

H=850 mm I cassetti H=50 mm hanno sempre estrazione flessibile



DIM. INTERNELxP



ESTRAZIONE



PORTATA



RAL 7035 + RAL 7016



RAL 5012



RAL 7035



### Armadio con 6 cassetti 1x50 3x150 2x200



ART.	cassetti		RAL	€
M33A100C010CZPD	100-75-50	92-96-100%	7035+7016	967,20
M33A100C010CZ08	100-75-50	92-96-100%	7035	900,00
M33A100C010CZ04	100-75-50	92-96-100%	5012	900,00
M33A100C010DAPD	200	100%	7035+7016	1117,20
M33A100C010DA08	200	100%	7035	1050,00
M33A100C010DA04	200	100%	5012	1050,00

**H=1000 mm** I cassetti H=50 mm hanno sempre estrazione flessibile

### Armadio con 6 cassetti 1x100 4x150 1x200



ART.	cassetti		RAL	€
M33A100C010DBPD	100-75-50	92-96-100%	7035+7016	960,30
M33A100C010DB08	100-75-50	92-96-100%	7035	898,50
M33A100C010DB04	100-75-50	92-96-100%	5012	898,50
M33A100C010DCPD	200	100%	7035+7016	1140,30
M33A100C010DC08	200	100%	7035	1078,50
M33A100C010DC04	200	100%	5012	1078,50

**H=1000 mm**

### Armadio con 7 cassetti 1x50 2x75 2x100 1x200 1x300



ART.	cassetti		RAL	€
M33A100C010BNPD	100-75-50	92-96-100%	7035+7016	1053,60
M33A100C010BN08	100-75-50	92-96-100%	7035	966,90
M33A100C010BN04	100-75-50	92-96-100%	5012	966,90
M33A100C010BPPD	200	100%	7035+7016	1233,60
M33A100C010BP08	200	100%	7035	1146,90
M33A100C010BP04	200	100%	5012	1146,90

**H=1000 mm** I cassetti H=50 mm hanno sempre estrazione flessibile

### Armadio con 7 cassetti 2x75 1x100 3x150 1x200



ART.	cassetti		RAL	€
M33A100C010AWPD	100-75-50	92-96-100%	7035+7016	1044,00
M33A100C010AW08	100-75-50	92-96-100%	7035	968,10
M33A100C010AW04	100-75-50	92-96-100%	5012	968,10
M33A100C010BHPD	200	100%	7035+7016	1254,00
M33A100C010BH08	200	100%	7035	1178,10
M33A100C010BH04	200	100%	5012	1178,10

**H=1000 mm**



### Armadio con 8 cassetti 1x50 2x75 2x100 2x150 1x200

ART.	cassetti		RAL	€
M33A100C010CUPD	100-75-50	92-96-100%	7035+7016	1130,10
M33A100C010CU08	100-75-50	92-96-100%	7035	1038,30
M33A100C010CU04	100-75-50	92-96-100%	5012	1038,30
M33A100C010CVPD	200	100%	7035+7016	1340,10
M33A100C010CV08	200	100%	7035	1248,30
M33A100C010CV04	200	100%	5012	1248,30

**H=1000 mm** I cassetti H=50 mm hanno sempre estrazione flessibile



### Armadio con 8 cassetti 2x75 3x100 3x150

ART.	cassetti		RAL	€
M33A100C010DDPD	100-75-50	92-96-100%	7035+7016	1123,20
M33A100C010DD08	100-75-50	92-96-100%	7035	1036,80
M33A100C010DD04	100-75-50	92-96-100%	5012	1036,80
M33A100C010DEPD	200	100%	7035+7016	1363,20
M33A100C010DE08	200	100%	7035	1276,80
M33A100C010DE04	200	100%	5012	1276,80

**H=1000 mm**



### Armadio con 9 cassetti 9x100

ART.	cassetti		RAL	€
M33A100C010BLPD	100-75-50	92-96-100%	7035+7016	1211,70
M33A100C010BL08	100-75-50	92-96-100%	7035	1106,40
M33A100C010BL04	100-75-50	92-96-100%	5012	1106,40
M33A100C010BMPD	200	100%	7035+7016	1481,70
M33A100C010BM08	200	100%	7035	1376,40
M33A100C010BM04	200	100%	5012	1376,40

**H=1000 mm**



### Armadio con 10 cassetti 1x50 2x75 7x100

ART.	cassetti		RAL	€
M33A100C010DFPD	100-75-50	92-96-100%	7035+7016	1295,40
M33A100C010DF08	100-75-50	92-96-100%	7035	1176,60
M33A100C010DF04	100-75-50	92-96-100%	5012	1176,60
M33A100C010DGPD	200	100%	7035+7016	1565,40
M33A100C010DG08	200	100%	7035	1446,60
M33A100C010DG04	200	100%	5012	1446,60

**H=1000 mm** I cassetti H=50 mm hanno sempre estrazione flessibile



DIM. INTERNELxP



ESTRAZIONE



PORTATA



RAL 7035 + RAL 7016



RAL 5012



RAL 7035







### Cassetto H 50 mm

Set composto da 16 divisori a 4 canali e 65 divisori trasversali 36 mm



### Cassetto H 75 mm

Set di predisposizione per termoformati



### Cassetto H 75 mm

Set di predisposizione per termoformati



### Cassetto H 100 mm

Set di predisposizione per termoformati



### Cassetto H 100 mm

Set composto da 3 divisori longitudinali fessurati 610 mm e 15 divisori trasversali 149 mm



### Cassetto H 200 mm

Set composto da 2 divisori longitudinali fessurati 610 mm e 3 divisori trasversali 200 mm



### Cassetto H 300 mm

Set composto da 1 divisorio longitudinale fessurato 610 mm



Utensili e termoformati esclusi

Disponibili in varie dimensioni



DIM. INTERNELxP



ESTRAZIONE



PORTATA



RAL 7035 + RAL 7016



RAL 5012



RAL 7035



### Armadio con porte con 2 cassetti 2x75 2xPE



ART.	cassetti / piani estraibili		RAL	€
M33A100C010LJPD	100-75-50	92-96-100%	7035+7016	922,50
M33A100C010LJ08	100-75-50	92-96-100%	7035	922,50
M33A100C010LJ04	100-75-50	92-96-100%	5012	922,50
M33A100C010LKPD	200	100%	7035+7016	1042,50
M33A100C010LK08	200	100%	7035	1042,50
M33A100C010LK04	200	100%	5012	1042,50

H=1022 mm

### Armadio con porte 2xPR 2xPE



ART.	piani estraibili		RAL	€
M33A100C010LMPD	100-75-50	92-96-100%	7035+7016	879,30
M33A100C010LM08	100-75-50	92-96-100%	7035	879,30
M33A100C010LM04	100-75-50	92-96-100%	5012	879,30
M33A100C010LNPD	200	100%	7035+7016	939,30
M33A100C010LN08	200	100%	7035	939,30
M33A100C010LN04	200	100%	5012	939,30

H=1022 mm

### Armadio con porte con 4 cassetti 4x75



ART.	cassetti		RAL	€
M33A100C010CCPD	100-75-50	92-96-100%	7035+7016	888,90
M33A100C010CC08	100-75-50	92-96-100%	7035	888,90
M33A100C010CC04	100-75-50	92-96-100%	5012	888,90
M33A100C010CDPD	200	100%	7035+7016	1008,90
M33A100C010CD08	200	100%	7035	1008,90
M33A100C010CD04	200	100%	5012	1008,90

H=1022 mm

### Armadio con porte con 3 cassetti 1x125 2x75 2xPE



ART.	cassetti / piani estraibili		RAL	€
M33A100C010LRPD	100-75-50	92-96-100%	7035+7016	1056,90
M33A100C010LR08	100-75-50	92-96-100%	7035	1045,20
M33A100C010LR04	100-75-50	92-96-100%	5012	1045,20
M33A100C010LSPD	200	100%	7035+7016	1206,90
M33A100C010LS08	200	100%	7035	1195,20
M33A100C010LS04	200	100%	5012	1195,20

H=1022 mm



### Armadio con porte con 5 cassetti 1x50 2x75 2x100 1xPE

ART.	cassetti / piani estraibili		RAL	€
M33A100C010LTPD	100-75-50	92-96-100%	7035+7016	1131,60
M33A100C010LT08	100-75-50	92-96-100%	7035	1106,40
M33A100C010LT04	100-75-50	92-96-100%	5012	1106,40
M33A100C010LUPD	200	100%	7035+7016	1281,60
M33A100C010LU08	200	100%	7035	1256,40
M33A100C010LU04	200	100%	5012	1256,40

**H=1022 mm** I cassetti H=50 mm hanno sempre estrazione flessibile



### Armadio con porte con 5 cassetti 1x50 4x75 1xPE

ART.	cassetti / piani estraibili		RAL	€
M33A100C010LVPD	100-75-50	92-96-100%	7035+7016	1124,40
M33A100C010LV08	100-75-50	92-96-100%	7035	1099,20
M33A100C010LV04	100-75-50	92-96-100%	5012	1099,20
M33A100C010LWPD	200	100%	7035+7016	1274,40
M33A100C010LW08	200	100%	7035	1249,20
M33A100C010LW04	200	100%	5012	1249,20

**H=1022 mm** I cassetti H=50 mm hanno sempre estrazione flessibile



### Armadio con porte scorrevoli con 4 cassetti 4x75 2xPE

ART.	cassetti / piani estraibili		RAL	€
M33D100C010GYPD	100-75-50	92-96-100%	7035+7016	1770,30
M33D100C010GY08	100-75-50	92-96-100%	7035	1770,30
M33D100C010GY04	100-75-50	92-96-100%	5012	1770,30
M33D100C010GZPD	200	100%	7035+7016	1950,30
M33D100C010GZ08	200	100%	7035	1950,30
M33D100C010GZ04	200	100%	5012	1950,30

**H=1022 mm**



### Armadio con porte scorrevoli 4xPR 2xPE

ART.	piani estraibili		RAL	€
M33D100C010JAPD	100-75-50	92-96-100%	7035+7016	1600,50
M33D100C010JA08	100-75-50	92-96-100%	7035	1600,50
M33D100C010JA04	100-75-50	92-96-100%	5012	1600,50
M33D100C010JBPD	200	100%	7035+7016	1660,50
M33D100C010JB08	200	100%	7035	1660,50
M33D100C010JB04	200	100%	5012	1660,50

**H=1022 mm**





### Armadio con porte scorrevoli con 4 cassetti 4x75 4xPE

ART.	cassetti / piani estraibili		RAL	€
M33D100C010HEPD	100-75-50	92-96-100%	7035+7016	1964,70
M33D100C010HE08	100-75-50	92-96-100%	7035	1964,70
M33D100C010HE04	100-75-50	92-96-100%	5012	1964,70
M33D100C010HFPD	200	100%	7035+7016	2204,70
M33D100C010HF08	200	100%	7035	2204,70
M33D100C010HF04	200	100%	5012	2204,70

H=1022 mm



### Armadio con 9 cassetti 2x75 2x100 1x150 3x200 1x300

ART.	cassetti		RAL	€
M33A150C010LXPD	100-75-50	92-96-100%	7035+7016	1367,10
M33A150C010LX08	100-75-50	92-96-100%	7035	1258,80
M33A150C010LX04	100-75-50	92-96-100%	5012	1258,80
M33A150C010LYPD	200	100%	7035+7016	1637,10
M33A150C010LY08	200	100%	7035	1528,80
M33A150C010LY04	200	100%	5012	1528,80

H=1500 mm



### Armadio con 9 cassetti 2x100 6x150 1x300

ART.	cassetti		RAL	€
M33A150C010FJPD	100-75-50	92-96-100%	7035+7016	1348,80
M33A150C010FJ08	100-75-50	92-96-100%	7035	1256,10
M33A150C010FJ04	100-75-50	92-96-100%	5012	1256,10
M33A150C010FKPD	200	100%	7035+7016	1618,80
M33A150C010FK08	200	100%	7035	1526,10
M33A150C010FK04	200	100%	5012	1526,10

H=1500 mm



### Armadio con 10 cassetti 1x50 4x100 1x150 4x200

ART.	cassetti		RAL	€
M33A150C010LZPD	100-75-50	92-96-100%	7035+7016	1452,90
M33A150C010LZ08	100-75-50	92-96-100%	7035	1331,70
M33A150C010LZ04	100-75-50	92-96-100%	5012	1331,70
M33A150C010MAPD	200	100%	7035+7016	1722,90
M33A150C010MA08	200	100%	7035	1601,70
M33A150C010MA04	200	100%	5012	1601,70

H=1500 mm I cassetti H=50 mm hanno sempre estrazione flessibile





### Armadio con porte con 3 cassetti 2x75 1x150 2xPE

ART.	cassetti / piani estraibili		RAL	€
M33A150C010LAPD	100-75-50	92-96-100%	7035+7016	1049,40
M33A150C010LA08	100-75-50	92-96-100%	7035	1049,40
M33A150C010LA04	100-75-50	92-96-100%	5012	1049,40
M33A150C010LBPD	200	100%	7035+7016	1199,40
M33A150C010LB08	200	100%	7035	1199,40
M33A150C010LB04	200	100%	5012	1199,40

H=1500 mm



### Armadio con porte 3xPR 2xPE

ART.	piani estraibili		RAL	€
M33A150C010LCPD	100-75-50	92-96-100%	7035+7016	973,80
M33A150C010LC08	100-75-50	92-96-100%	7035	973,80
M33A150C010LC04	100-75-50	92-96-100%	5012	973,80
M33A150C010LDPD	200	100%	7035+7016	1033,80
M33A150C010LD08	200	100%	7035	1033,80
M33A150C010LD04	200	100%	5012	1033,80

H=1500 mm



### Armadio con porte con 5 cassetti 2x75 3x150

ART.	cassetti		RAL	€
M33A150C010LEPD	100-75-50	92-96-100%	7035+7016	1037,40
M33A150C010LE08	100-75-50	92-96-100%	7035	1037,40
M33A150C010LE04	100-75-50	92-96-100%	5012	1037,40
M33A150C010LFPD	200	100%	7035+7016	1187,40
M33A150C010LF08	200	100%	7035	1187,40
M33A150C010LF04	200	100%	5012	1187,40

H=1500 mm



PE: PIANO ESTRAIBILE  
PR: PIANO REGOLABILE



DIM. INTERNEL x P



ESTRAZIONE



PORTATA



RAL 7035 + RAL 7016



RAL 5012



RAL 7035



### Armadio con 7 cassetti 2xPR 2x75 1x100 3x150 1x200

ART.	cassetti		RAL	€
M33A200C010FSPD	100-75-50	92-96-100%	7035+7016	1420,50
M33A200C010FS08	100-75-50	92-96-100%	7035	1344,60
M33A200C010FS04	100-75-50	92-96-100%	5012	1344,60
M33A200C010FTPD	200	100%	7035+7016	1630,50
M33A200C010FT08	200	100%	7035	1554,60
M33A200C010FT04	200	100%	5012	1554,60

H=2000 mm



### Armadio con porte con 3 cassetti 2xPR 2x100 1x150 2xPE

ART.	cassetti / piani estraibili		RAL	€
M33A200C010FWPD	100-75-50	92-96-100%	7035+7016	1379,40
M33A200C010FW08	100-75-50	92-96-100%	7035	1379,40
M33A200C010FW04	100-75-50	92-96-100%	5012	1379,40
M33A200C010FXPD	200	100%	7035+7016	1529,40
M33A200C010FX08	200	100%	7035	1529,40
M33A200C010FX04	200	100%	5012	1529,40

H=2000 mm



### Armadio con porte con 7 cassetti 3xPR 2x75 1x100 3x150 1x200

ART.	cassetti		RAL	€
M33A200C010FYPD	100-75-50	92-96-100%	7035+7016	1719,60
M33A200C010FY08	100-75-50	92-96-100%	7035	1643,70
M33A200C010FY04	100-75-50	92-96-100%	5012	1643,70
M33A200C010FZPD	200	100%	7035+7016	1929,60
M33A200C010FZ08	200	100%	7035	1853,70
M33A200C010FZ04	200	100%	5012	1853,70

H=2000 mm





### Armadio con ruote con 3 cassetti 1x100 1x200 1x300

ART.	cassetti		RAL	€
M33R070C01029PD	100-75-50	92-96-100%	7035+7016	899,40
M33R070C0102908	100-75-50	92-96-100%	7035	861,30
M33R070C0102904	100-75-50	92-96-100%	5012	861,30

**H=922 mm** Ruote: Gomma elastica Ø 125 mm  
Portata armadio: 750 kg



### Armadio con ruote con 5 cassetti 1x50 2x100 1x150 1x200

ART.	cassetti		RAL	€
M33R070C01040PD	100-75-50	92-96-100%	7035+7016	1062,00
M33R070C0104008	100-75-50	92-96-100%	7035	1002,90
M33R070C0104004	100-75-50	92-96-100%	5012	1002,90

**H=922 mm** Ruote: Gomma elastica Ø 125 mm  
Portata armadio: 750 kg



### Armadio con ruote con 6 cassetti 2x75 3x100 1x150

ART.	cassetti		RAL	€
M33R070C01044PD	100-75-50	92-96-100%	7035+7016	1138,80
M33R070C0104408	100-75-50	92-96-100%	7035	1071,00
M33R070C0104404	100-75-50	92-96-100%	5012	1071,00

**H=922 mm** Ruote: Gomma elastica Ø 125 mm  
Portata armadio: 750 kg



### Armadio con ruote con 7 cassetti 2x75 2x100 2x125 1x150

ART.	cassetti		RAL	€
M33R085C010ACPD	100-75-50	92-96-100%	7035+7016	1258,80
M33R085C010AC08	100-75-50	92-96-100%	7035	1179,30
M33R085C010AC04	100-75-50	92-96-100%	5012	1179,30

**H=1072 mm** Ruote: Gomma elastica Ø 125 mm  
Portata armadio: 750 kg



### Armadio con ruote con 8 cassetti 4x75 3x100 1x150

ART.	cassetti		RAL	€
M33R085C010AGPD	100-75-50	92-96-100%	7035+7016	1341,30
M33R085C010AG08	100-75-50	92-96-100%	7035	1250,10
M33R085C010AG04	100-75-50	92-96-100%	5012	1250,10

**H=1072 mm** Ruote: Gomma elastica Ø 125 mm  
Portata armadio: 750 kg





### Armadio con 7 cassetti 1x50 2x75 2x100 1x150 1x200



ART.	cassetti		RAL	€
M43A085C010AEPD	100-75-50	92-96-100%	7035+7016	1249,50
M43A085C010AE08	100-75-50	92-96-100%	7035	1147,50
M43A085C010AE04	100-75-50	92-96-100%	5012	1147,50
M43A085C010AFPDP	200	100%	7035+7016	1429,50
M43A085C010AF08	200	100%	7035	1327,50
M43A085C010AF04	200	100%	5012	1327,50

**H=850 mm** I cassetti H=50 mm hanno sempre estrazione flessibile

### Armadio con 7 cassetti 2x75 2x100 2x125 1x150



ART.	cassetti		RAL	€
M43A085C010ACPD	100-75-50	92-96-100%	7035+7016	1234,20
M43A085C010AC08	100-75-50	92-96-100%	7035	1141,20
M43A085C010AC04	100-75-50	92-96-100%	5012	1141,20
M43A085C010ADPDP	200	100%	7035+7016	1444,20
M43A085C010AD08	200	100%	7035	1351,20
M43A085C010AD04	200	100%	5012	1351,20

**H=850 mm**

### Armadio con 8 cassetti 4x75 3x100 1x150



ART.	cassetti		RAL	€
M43A085C010AGPDP	100-75-50	92-96-100%	7035+7016	1338,30
M43A085C010AG08	100-75-50	92-96-100%	7035	1227,30
M43A085C010AG04	100-75-50	92-96-100%	5012	1227,30
M43A085C010AHPDP	200	100%	7035+7016	1578,30
M43A085C010AH08	200	100%	7035	1467,30
M43A085C010AH04	200	100%	5012	1467,30

**H=850 mm**

### Armadio con 7 cassetti 1x50 2x75 2x100 1x200 1x300



ART.	cassetti		RAL	€
M43A100C010BNPDP	100-75-50	92-96-100%	7035+7016	1294,80
M43A100C010BN08	100-75-50	92-96-100%	7035	1188,60
M43A100C010BN04	100-75-50	92-96-100%	5012	1188,60
M43A100C010BPPDP	200	100%	7035+7016	1474,80
M43A100C010BP08	200	100%	7035	1368,60
M43A100C010BP04	200	100%	5012	1368,60

**H=1000 mm** I cassetti H=50 mm hanno sempre estrazione flessibile



### Armadio con 8 cassetti 1x50 2x75 3x100 1x150 1x250

ART.	cassetti		RAL	€
M43A100C010BQPD	100-75-50	92-96-100%	7035+7016	1385,40
M43A100C010BQ08	100-75-50	92-96-100%	7035	1275,00
M43A100C010BQ04	100-75-50	92-96-100%	5012	1275,00
M43A100C010BRPD	200	100%	7035+7016	1595,40
M43A100C010BR08	200	100%	7035	1485,00
M43A100C010BR04	200	100%	5012	1485,00

**H=1000 mm** I cassetti H=50 mm hanno sempre estrazione flessibile



### Armadio con 9 cassetti 3x50 2x75 2x100 1x150 1x250

ART.	cassetti		RAL	€
M43A100C010CSPD	100-75-50	92-96-100%	7035+7016	1490,70
M43A100C010CS08	100-75-50	92-96-100%	7035	1365,90
M43A100C010CS04	100-75-50	92-96-100%	5012	1365,90
M43A100C010CTPD	200	100%	7035+7016	1670,70
M43A100C010CT08	200	100%	7035	1545,90
M43A100C010CT04	200	100%	5012	1545,90

**H=1000 mm** I cassetti H=50 mm hanno sempre estrazione flessibile



### Armadio con 9 cassetti 3x100 4x150 1x200 1x300

ART.	cassetti		RAL	€
M43A150C010FAPD	100-75-50	92-96-100%	7035+7016	1682,70
M43A150C010FA08	100-75-50	92-96-100%	7035	1564,50
M43A150C010FA04	100-75-50	92-96-100%	5012	1564,50
M43A150C010FBPD	200	100%	7035+7016	1952,70
M43A150C010FB08	200	100%	7035	1834,50
M43A150C010FB04	200	100%	5012	1834,50

**H=1500 mm**



### Armadio con 9 cassetti 8x150 1x200

ART.	cassetti		RAL	€
M43A150C010EYPD	100-75-50	92-96-100%	7035+7016	1664,40
M43A150C010EY08	100-75-50	92-96-100%	7035	1563,00
M43A150C010EY04	100-75-50	92-96-100%	5012	1563,00
M43A150C010EZPD	200	100%	7035+7016	1934,40
M43A150C010EZ08	200	100%	7035	1833,00
M43A150C010EZ04	200	100%	5012	1833,00

**H=1500 mm**



DIM. INTERNELxP



ESTRAZIONE



PORTATA



RAL 7035 + RAL 7016



RAL 5012



RAL 7035



### Armadio con 5 cassetti 3x100 1x150 1x300



ART.	cassetti		RAL	€
M53A085C010AKPD	100-75-50	92-96-100%	7035+7016	1040,10
M53A085C010AK08	100-75-50	92-96-100%	7035	945,30
M53A085C010AK04	100-75-50	92-96-100%	5012	945,30
M53A085C010ALPD	200	100%	7035+7016	1190,10
M53A085C010AL08	200	100%	7035	1095,30
M53A085C010AL04	200	100%	5012	1095,30

H=850 mm

### Armadio con 6 cassetti 2x75 2x100 1x150 1x250



ART.	cassetti		RAL	€
M53A085C010AMPD	100-75-50	92-96-100%	7035+7016	1140,30
M53A085C010AM08	100-75-50	92-96-100%	7035	1025,40
M53A085C010AM04	100-75-50	92-96-100%	5012	1025,40
M53A085C010ANPD	200	100%	7035+7016	1320,30
M53A085C010AN08	200	100%	7035	1205,40
M53A085C010AN04	200	100%	5012	1205,40

H=850 mm

### Armadio con 7 cassetti 1x50 2x75 2x100 1x150 1x200



ART.	cassetti		RAL	€
M53A085C010AEPD	100-75-50	92-96-100%	7035+7016	1248,60
M53A085C010AE08	100-75-50	92-96-100%	7035	1111,50
M53A085C010AE04	100-75-50	92-96-100%	5012	1111,50
M53A085C010AFPDP	200	100%	7035+7016	1428,60
M53A085C010AF08	200	100%	7035	1291,50
M53A085C010AF04	200	100%	5012	1291,50

H=850 mm I cassetti H=50 mm hanno sempre estrazione flessibile

### Armadio con 5 cassetti 2x100 2x200 1x300



ART.	cassetti		RAL	€
M53A100C010EAPD	100-75-50	92-96-100%	7035+7016	1086,00
M53A100C010EA08	100-75-50	92-96-100%	7035	993,90
M53A100C010EA04	100-75-50	92-96-100%	5012	993,90
M53A100C010EBPD	200	100%	7035+7016	1236,00
M53A100C010EB08	200	100%	7035	1143,90
M53A100C010EB04	200	100%	5012	1143,90

H=1000 mm



### Armadio con 6 cassetti 1x100 4x150 1x200



ART.	cassetti		RAL	€
M53A100C010DBPD	100-75-50	92-96-100%	7035+7016	1198,20
M53A100C010DB08	100-75-50	92-96-100%	7035	1088,40
M53A100C010DB04	100-75-50	92-96-100%	5012	1088,40
M53A100C010DCPD	200	100%	7035+7016	1378,20
M53A100C010DC08	200	100%	7035	1268,40
M53A100C010DC04	200	100%	5012	1268,40

H=1000 mm

### Armadio con 7 cassetti 1x50 2x75 2x100 1x200 1x300



ART.	cassetti		RAL	€
M53A100C010BNPD	100-75-50	92-96-100%	7035+7016	1292,10
M53A100C010BN08	100-75-50	92-96-100%	7035	1154,40
M53A100C010BN04	100-75-50	92-96-100%	5012	1154,40
M53A100C010BPPD	200	100%	7035+7016	1472,10
M53A100C010BP08	200	100%	7035	1334,40
M53A100C010BP04	200	100%	5012	1334,40

H=1000 mm I cassetti H=50 mm hanno sempre estrazione flessibile

### Armadio con 7 cassetti 2x75 1x100 3x150 1x200



ART.	cassetti		RAL	€
M53A100C010AWPD	100-75-50	92-96-100%	7035+7016	1299,60
M53A100C010AW08	100-75-50	92-96-100%	7035	1167,90
M53A100C010AW04	100-75-50	92-96-100%	5012	1167,90
M53A100C010BHPD	200	100%	7035+7016	1509,60
M53A100C010BH08	200	100%	7035	1377,90
M53A100C010BH04	200	100%	5012	1377,90

H=1000 mm

### Armadio con 8 cassetti 1x50 2x75 2x100 2x150 1x200



ART.	cassetti		RAL	€
M53A100C010CUPD	100-75-50	92-96-100%	7035+7016	1404,30
M53A100C010CU08	100-75-50	92-96-100%	7035	1248,90
M53A100C010CU04	100-75-50	92-96-100%	5012	1248,90
M53A100C010CVPD	200	100%	7035+7016	1614,30
M53A100C010CV08	200	100%	7035	1458,90
M53A100C010CV04	200	100%	5012	1458,90

H=1000 mm I cassetti H=50 mm hanno sempre estrazione flessibile



DIM. INTERNELxP



ESTRAZIONE



PORTATA



RAL 7035 + RAL 7016



RAL 5012



RAL 7035



### Armadio con 8 cassetti 2x75 3x100 3x150



ART.	cassetti		RAL	€
M53A100C010DDPD	100-75-50	92-96-100%	7035+7016	1409,40
M53A100C010DD08	100-75-50	92-96-100%	7035	1256,70
M53A100C010DD04	100-75-50	92-96-100%	5012	1256,70
M53A100C010DEPD	200	100%	7035+7016	1649,40
M53A100C010DE08	200	100%	7035	1496,70
M53A100C010DE04	200	100%	5012	1496,70

H=1000 mm

### Armadio con 10 cassetti 1x50 2x75 7x100



ART.	cassetti		RAL	€
M53A100C010DFPD	100-75-50	92-96-100%	7035+7016	1623,90
M53A100C010DF08	100-75-50	92-96-100%	7035	1426,50
M53A100C010DF04	100-75-50	92-96-100%	5012	1426,50
M53A100C010DGPD	200	100%	7035+7016	1893,90
M53A100C010DG08	200	100%	7035	1696,50
M53A100C010DG04	200	100%	5012	1696,50

H=1000 mm I cassetti H=50 mm hanno sempre estrazione flessibile

### Armadio con 9 cassetti 2x75 2x100 1x150 3x200 1x300



ART.	cassetti		RAL	€
M53A150C010LXPD	100-75-50	92-96-100%	7035+7016	1682,40
M53A150C010LX08	100-75-50	92-96-100%	7035	1514,40
M53A150C010LX04	100-75-50	92-96-100%	5012	1514,40
M53A150C010LYPD	200	100%	7035+7016	1952,40
M53A150C010LY08	200	100%	7035	1784,40
M53A150C010LY04	200	100%	5012	1784,40

H=1500 mm

### Armadio con 9 cassetti 2x100 6x150 1x300



ART.	cassetti		RAL	€
M53A150C010FJPD	100-75-50	92-96-100%	7035+7016	1690,80
M53A150C010FJ08	100-75-50	92-96-100%	7035	1523,70
M53A150C010FJ04	100-75-50	92-96-100%	5012	1523,70
M53A150C010FKPD	200	100%	7035+7016	1960,80
M53A150C010FK08	200	100%	7035	1793,70
M53A150C010FK04	200	100%	5012	1793,70

H=1500 mm





### Armadio con 10 cassetti 1x50 4x100 1x150 4x200

ART.	cassetti		RAL	€
	KG			
M53A150C010LZPD	100-75-50	92-96-100%	7035+7016	1797,90
M53A150C010LZ08	100-75-50	92-96-100%	7035	1610,40
M53A150C010LZ04	100-75-50	92-96-100%	5012	1610,40
M53A150C010MAPD	200	100%	7035+7016	2067,90
M53A150C010MA08	200	100%	7035	1880,40
M53A150C010MA04	200	100%	5012	1880,40

**H=1500 mm** I cassetti H=50 mm hanno sempre estrazione flessibile



### Armadio 2xPF 2xPE

ART.	piani estraibili		RAL	€
	KG			
M53A200C010SVPD	200	100%	7035+7016	1131,90
M53A200C010SV08	200	100%	7035	1091,70
M53A200C010SV04	200	100%	5012	1091,70

**H=2000 mm**



### Armadio con 4 cassetti 2xPF 1x150 1x200 1x250 1x300

ART.	cassetti		RAL	€
	KG			
M53A200C010SXPD	200	100%	7035+7016	1500,00
M53A200C010SX08	200	100%	7035	1427,40
M53A200C010SX04	200	100%	5012	1427,40

**H=2000 mm**





### Armadio con 7 cassetti 2xPF 1x75 1x100 1x125 1x150 2x200

ART.	cassetti		RAL	€
M53A200C010SWPD	200	100%	7035+7016	1884,30
M53A200C010SW08	200	100%	7035	1750,80
M53A200C010SW04	200	100%	5012	1750,80

**H=2000 mm** I cassetti H=50 mm hanno sempre estrazione flessibile



### Armadio con porte 2xPF 2xPE

ART.	piani estraibili		RAL	€
M53A200C010SUPD	100-75-50	92-96-100%	7035+7016	1216,50
M53A200C010SU08	100-75-50	92-96-100%	7035	1216,50
M53A200C010SU04	100-75-50	92-96-100%	5012	1216,50

**H=2000 mm**



### Armadio con porte con 7 cassetti 3xPR 2x75 1x100 3x150 1x200

ART.	cassetti		RAL	€
M53A200C010FYPD	100-75-50	92-96-100%	7035+7016	2086,80
M53A200C010FY08	100-75-50	92-96-100%	7035	1955,10
M53A200C010FY04	100-75-50	92-96-100%	5012	1955,10
M53A200C010FZPD	200	100%	7035+7016	2296,80
M53A200C010FZ08	200	100%	7035	2165,10
M53A200C010FZ04	200	100%	5012	2165,10

**H=2000 mm**



### Armadio con porte con 3 cassetti 2xPR 2x100 1x150 2xPE

ART.	cassetti / piani estraibili		RAL	€
	KG			
M53A200C010FWPD	100-75-50	92-96-100%	7035+7016	1606,80
M53A200C010FW08	100-75-50	92-96-100%	7035	1606,80
M53A200C010FW04	100-75-50	92-96-100%	5012	1606,80
M53A200C010FXPD	200	100%	7035+7016	1756,80
M53A200C010FX08	200	100%	7035	1756,80
M53A200C010FX04	200	100%	5012	1756,80

H=2000 mm



### Armadio con ruote con 7 cassetti 2x75 3x100 2x150

ART.	cassetti		RAL	€
	KG			
M53R085C01095PD	100-75-50	92-96-100%	7035+7016	1598,10
M53R085C0109508	100-75-50	92-96-100%	7035	1463,70
M53R085C0109504	100-75-50	92-96-100%	5012	1463,70

H=1072 mm

Ruote: Gomma elastica Ø 160 mm  
Portata armadio: 900 kg



PE: PIANO ESTRAIBILE  
PR: PIANO REGOLABILE  
PF: PIANO FESSURATO



DIM. INTERNEL x P



ESTRAZIONE



PORTATA



RAL 7035 + RAL 7016



RAL 5012



RAL 7035



### Armadio con 7 cassetti 2x75 2x100 1x150 2x200



ART.	cassetti		RAL	€
	KG			
M63A100C010DYPD	100-75-50	92-96-100%	7035+7016	1499,70
M63A100C010DY08	100-75-50	92-96-100%	7035	1457,10
M63A100C010DY04	100-75-50	92-96-100%	5012	1457,10
M63A100C010DZPD	200	100%	7035+7016	1709,70
M63A100C010DZ08	200	100%	7035	1667,10
M63A100C010DZ04	200	100%	5012	1667,10

H=1000 mm

### Armadio con 8 cassetti 2x75 4x100 1x150 1x200



ART.	cassetti		RAL	€
	KG			
M63A100C010CNPDP	100-75-50	92-96-100%	7035+7016	1622,10
M63A100C010CN08	100-75-50	92-96-100%	7035	1577,70
M63A100C010CN04	100-75-50	92-96-100%	5012	1577,70
M63A100C010CPPD	200	100%	7035+7016	1862,10
M63A100C010CP08	200	100%	7035	1817,70
M63A100C010CP04	200	100%	5012	1817,70

H=1000 mm

### Armadio con 8 cassetti 2x75 3x100 3x150



ART.	cassetti		RAL	€
	KG			
M63A100C010DDPD	100-75-50	92-96-100%	7035+7016	1620,00
M63A100C010DD08	100-75-50	92-96-100%	7035	1570,20
M63A100C010DD04	100-75-50	92-96-100%	5012	1570,20
M63A100C010DEPD	200	100%	7035+7016	1860,00
M63A100C010DE08	200	100%	7035	1810,20
M63A100C010DE04	200	100%	5012	1810,20

H=1000 mm

### Armadio con 10 cassetti 2x150 1x125 1x75 2x100 2x150 2x200



ART.	cassetti		RAL	€
	KG			
M63A150C010MCPD	200	100%	7035+7016	2417,70
M63A150C010MC08	200	100%	7035	2341,80
M63A150C010MC04	200	100%	5012	2341,80

H=1500 mm



### Armadio con 11 cassetti 1x150 1x125 1x75 4x100 3x150 1x200

ART.	cassetti		RAL	€
	KG			
M63A150C010MEPD	200	100%	7035+7016	2570,10
M63A150C010ME08	200	100%	7035	2492,40
M63A150C010ME04	200	100%	5012	2492,40

H=1500 mm



### Armadio con 7 cassetti 2xPR 2x75 1x100 3x150 1x200

ART.	cassetti		RAL	€
	KG			
M63A200C010FTPD	200	100%	7035+7016	2253,00
M63A200C010FT08	200	100%	7035	2205,00
M63A200C010FT04	200	100%	5012	2205,00

H=2000 mm



### Armadio con porte con 7 cassetti 3xPR 2x75 1x100 3x150 1x200

ART.	cassetti		RAL	€
	KG			
M63A200C010FZPD	200	100%	7035+7016	2668,20
M63A200C010FZ08	200	100%	7035	2620,20
M63A200C010FZ04	200	100%	5012	2620,20

H=2000 mm





### Armadio con 5 cassetti 2x100 2x200 1x300



ART.	cassetti		RAL	€
M73A100C010EAPD	100-75-50	92-96-100%	7035+7016	1474,20
M73A100C010EA08	100-75-50	92-96-100%	7035	1388,40
M73A100C010EA04	100-75-50	92-96-100%	5012	1388,40
M73A100C010EBPD	200	100%	7035+7016	1624,20
M73A100C010EB08	200	100%	7035	1538,40
M73A100C010EB04	200	100%	5012	1538,40

H=1000 mm

### Armadio con 7 cassetti 2x75 2x100 1x150 2x200



ART.	cassetti		RAL	€
M73A100C010DYPD	100-75-50	92-96-100%	7035+7016	1729,80
M73A100C010DY08	100-75-50	92-96-100%	7035	1606,20
M73A100C010DY04	100-75-50	92-96-100%	5012	1606,20
M73A100C010DZPD	200	100%	7035+7016	1939,80
M73A100C010DZ08	200	100%	7035	1816,20
M73A100C010DZ04	200	100%	5012	1816,20

H=1000 mm

### Armadio con 8 cassetti 2x75 4x100 1x150 1x200



ART.	cassetti		RAL	€
M73A100C010CNPDP	100-75-50	92-96-100%	7035+7016	1889,40
M73A100C010CN08	100-75-50	92-96-100%	7035	1733,10
M73A100C010CN04	100-75-50	92-96-100%	5012	1733,10
M73A100C010CPPD	200	100%	7035+7016	2129,40
M73A100C010CP08	200	100%	7035	1973,10
M73A100C010CP04	200	100%	5012	1973,10

H=1000 mm



### Armadio con 10 cassetti 2x150 1x125 1x75 2x100 2x150 2x200

ART.	cassetti		RAL	€
M73A150C010MCPD	200	100%	7035+7016	2682,00
M73A150C010MC08	200	100%	7035	2513,40
M73A150C010MC04	200	100%	5012	2513,40

H=1500 mm





### Armadio con 11 cassetti 1x150 1x125 1x75 4x100 3x150 1x200

ART.	cassetti		RAL	€
M73A150C010MEPD	200	100%	7035+7016	2871,60
M73A150C010ME08	200	100%	7035	2670,30
M73A150C010ME04	200	100%	5012	2670,30

H=1500 mm



### Armadio con 7 cassetti 2xPR 2x75 1x100 3x150 1x200

ART.	cassetti		RAL	€
M73A200C010FTPD	200	100%	7035+7016	2450,70
M73A200C010FT08	200	100%	7035	2335,50
M73A200C010FT04	200	100%	5012	2335,50

H=2000 mm



### Armadio con porte con 7 cassetti 3xPR 2x75 1x100 3x150 1x200

ART.	cassetti		RAL	€
M73A200C010FZPD	200	100%	7035+7016	2882,40
M73A200C010FZ08	200	100%	7035	2767,20
M73A200C010FZ04	200	100%	5012	2767,20

H=2000 mm





## Accessori



### Top in acciaio inox

ART.	adatto per armadio EH	L mm	P mm	H mm	€
M12T030MDNX710A	18x27	408	573	31	132,60
M22T030MDNX710A	27x27	561	573	31	151,80
M32T030MDNX710A	36x27	714	573	31	172,20
M52T030MDNX710A	54x27	1020	573	31	214,50
M23T030MDNX710A	27x36	561	726	31	172,80
M33T030MDNX710A	36x36	714	726	31	197,70
M43T030MDNX710A	45x36	867	726	31	225,30
M53T030MDNX710A	54x36	1020	726	31	247,80
M63T030MDNX710A	64x36	1190	726	31	276,60
M73T030MDNX710A	78x36	1428	726	31	316,20



### Top in acciaio gommato

ART.	adatto per armadio EH	L mm	P mm	H mm	colore	€
M12T030MDGM7107	18x27	408	573	32	Nero	123,00
M22T030MDGM7107	27x27	561	573	32	Nero	143,10
M32T030MDGM7107	36x27	714	573	32	Nero	150,60
M52T030MDGM7107	54x27	1020	573	32	Nero	209,10
M23T030MDGM7107	27x36	561	726	32	Nero	151,50
M33T030MDGM7107	36x36	714	726	32	Nero	159,30
M43T030MDGM7107	45x36	867	726	32	Nero	186,00
M53T030MDGM7107	54x36	1020	726	32	Nero	220,20
M63T030MDGM7107	64x36	1190	726	32	Nero	231,30
M73T030MDGM7107	78x36	1428	726	32	Nero	246,90



### Top in multiplex

ART.	adatto per armadio EH	L mm	P mm	H mm	€
M12T030MU000100	18x27	408	573	30	74,40
M22T030MU000100	27x27	561	573	30	84,30
M32T030MU000100	36x27	714	573	30	87,90
M52T030MU000100	54x27	1020	573	30	107,40
M23T030MU000100	27x36	561	726	30	94,80
M33T030MU000100	36x36	714	726	30	100,20
M43T030MU000100	45x36	867	726	30	121,20
M53T030MU000100	54x36	1020	726	30	120,30
M63T030MU000100	64x36	1190	726	30	137,10
M73T030MU000100	78x36	1428	726	30	153,00



## Accessori



### Top a 3 bordi rivestito in pvc

ART.	adatto per armadio EH	L mm	P mm	H mm	colore	€
M12T023AG003107	18x27	409	576	23	Nero	46,80
M22T023AG003107	27x27	562	576	23	Nero	55,50
M32T023AG003107	36x27	715	576	23	Nero	56,10
M52T023AG003107	54x27	1021	576	23	Nero	79,50
M23T023AG003107	27x36	562	729	23	Nero	56,10
M33T023AG003107	36x36	715	729	23	Nero	83,70
M43T023AG003107	45x36	868	729	23	Nero	90,00
M53T023AG003107	54x36	1021	729	23	Nero	85,80
M63T023AG003107	64x36	1191	729	23	Nero	92,40
M73T023AG003107	78x36	1429	729	23	Nero	92,40

### Zoccolo di rialzo H=50 mm



ART.	adatto per armadio EH	L mm	P mm	H mm	RAL	€
M12Z05000000008	18x27	406	572	50	7035	56,40
M12Z05000000004	18x27	406	572	50	5012	56,40
M22Z05000000008	27x27	559	572	50	7035	57,30
M22Z05000000004	27x27	559	572	50	5012	57,30
M32Z05000000008	36x27	712	572	50	7035	57,30
M32Z05000000004	36x27	712	572	50	5012	57,30
M52Z05000000008	54x27	1018	572	50	7035	63,90
M52Z05000000004	54x27	1018	572	50	5012	63,90
M23Z05000000008	27x36	559	725	50	7035	57,30
M23Z05000000004	27x36	559	725	50	5012	57,30
M33Z05000000008	36x36	712	725	50	7035	57,30
M33Z05000000004	36x36	712	725	50	5012	57,30
M43Z05000000008	45x36	865	725	50	7035	64,20
M43Z05000000004	45x36	865	725	50	5012	64,20
M53Z05000000008	54x36	1018	725	50	7035	63,90
M53Z05000000004	54x36	1018	725	50	5012	63,90
M63Z05000000008	64x36	1188	725	50	7035	66,90
M63Z05000000004	64x36	1188	725	50	5012	66,90
M73Z05000000008	78x36	1426	725	50	7035	73,80
M73Z05000000004	78x36	1426	725	50	5012	73,80



## Accessori

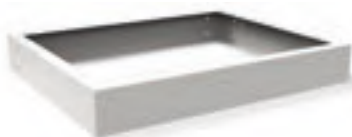

### Zoccolo di rialzo H=100 mm

ART.	adatto per armadio EH	Lmm	Pmm	Hmm	RAL	€
M12Z10000000008	18x27	406	572	100	7035	59,40
M12Z10000000004	18x27	406	572	100	5012	59,40
M22Z10000000008	27x27	559	572	100	7035	61,50
M22Z10000000004	27x27	559	572	100	5012	61,50
M32Z10000000008	36x27	712	572	100	7035	66,00
M32Z10000000004	36x27	712	572	100	5012	66,00
M52Z10000000008	54x27	1018	572	100	7035	72,00
M52Z10000000004	54x27	1018	572	100	5012	72,00
M23Z10000000008	27x36	559	725	100	7035	61,80
M23Z10000000004	27x36	559	725	100	5012	61,80
M33Z10000000008	36x36	712	725	100	7035	66,90
M33Z10000000004	36x36	712	725	100	5012	66,90
M43Z10000000008	45x36	865	725	100	7035	72,30
M43Z10000000004	45x36	865	725	100	5012	72,30
M53Z10000000008	54x36	1018	725	100	7035	74,40
M53Z10000000004	54x36	1018	725	100	5012	74,40
M63Z10000000008	64x36	1188	725	100	7035	78,90
M63Z10000000004	64x36	1188	725	100	5012	78,90
M73Z10000000008	78x36	1426	725	100	7035	83,10
M73Z10000000004	78x36	1426	725	100	5012	83,10





## Accessori

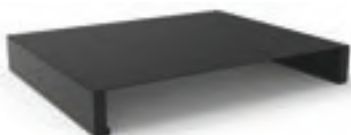

### Zoccolo per carrello elevatore e transpallet

ART.	adatto per armadio EH	L mm	P mm	H mm	RAL	€
M32Z1001000007	36x27	712	569	100	9005	86,40
M23Z1001000007	27x36	559	722	100	9005	91,80
M33Z1001000007	36x36	712	722	100	9005	93,60
M43Z1001000007	45x36	865	722	100	9005	116,40

### Chiusura per zoccolo

ART.	adatto per armadio L EH	L mm	P mm	H mm	RAL	€
M20Z10011000007	27	555	46	95	9005	30,00
M30Z10011000007	36	708	46	95	9005	19,20
M40Z10011000007	45	861	46	95	9005	30,30



### Coppia zoccoli per carrello elevatore e transpallet

ART.	adatto per armadio EH	L mm	P mm	H mm	RAL	€
M02Z1002000007	54x27	200	569	100	9005	66,60
M03Z1002000007	54x36 64x36 78x36	200	722	100	9005	74,40



### Chiusura per zoccolo

ART.	adatto per armadio L EH	L mm	P mm	H mm	RAL	€
M50Z10021000007	54	1014	46	95	9005	27,90
M60Z10021000007	64	1184	46	95	9005	31,50
M70Z10021000007	78	1422	46	95	9005	34,50



RAL 5012



RAL 7035



RAL 9005

**Materiale di separazione**

ART.	adatto per cassetto H mm	componenti	€
FFH82050200	50/300	16 x Divisorio trasversale L=36 mm 7 x Divisorio trasversale L=47 mm 3 x Divisorio a 3 canali 3 x Divisorio a 4 canali	12,30



ART.	adatto per cassetto H mm	componenti	€
FFH82050300	50/300	15 x Divisorio trasversale L=47 mm 8 x Divisorio trasversale L=73 mm 3 x Divisorio a 2 canali 3 x Divisorio a 3 canali	12,30



ART.	adatto per cassetto H mm	componenti	€
FFH82050400	50/300	18 x Divisorio trasversale L=73 mm 6 x Divisorio a 2 canali	11,70



ART.	adatto per cassetto H mm	componenti	€
FFH80050800	50	2 x Divisorio trasversale L=151 mm 1 x Divisorio longitudinale fessurato L=457 mm	4,80
FFH80070800	75		4,20
FFH80100800	100/125		5,70
FFH80150800	150/175		7,80
FFH80200800	200/250		12,90
FFH80300800	300		20,10



ART.	adatto per cassetto H mm	componenti	€
FFH80050900	50	2 x Divisorio longitudinale fessurato L=457 mm 6 x Divisorio trasversale L=100 mm	9,90
FFH80070900	75		9,00
FFH80100900	100/125		12,00
FFH80150900	150/175		16,50



ART.	adatto per cassetto H mm	componenti	€
FFH84051300	50	2 x Divisorio longitudinale non fessurato L=457 mm	8,10
FFH84071300	75		8,10
FFH84101300	100/125		8,70
FFH84151300	150/175		11,10
FFH84201300	200/250		12,90





## Materiale di separazione



ART.	adatto per cassetto H mm	componenti	€
FFH82051800	50	4 x Cassetta divisorio 150x75 mm 4 x Cassetta divisorio 150x150 mm	9,60
FFH82071800	75		12,00
FFH82101800	100/125		14,40



ART.	adatto per cassetto H mm	componenti	€
FFH82051700	50	4 x Cassetta divisorio 75x75 mm 6 x Cassetta divisorio 150x75 mm	10,50
FFH82071700	75	2 x Cassetta divisorio 150x150 mm	14,40



ART.	adatto per cassetto H mm	componenti	€
FFH86051900	50/300	2 x Portautensili multiuso	18,60





## Materiale di separazione



ART.	adatto per cassetto H mm	componenti	€
FFH84050200	50/300	16 x Divisorio trasversale L=36 mm 7 x Divisorio trasversale L=47 mm 6 x Divisorio a 3 canali 3 x Divisorio a 4 canali	21,30



ART.	adatto per cassetto H mm	componenti	€
FFH84050300	50/300	15 x Divisorio trasversale L=47 mm 8 x Divisorio trasversale L=73 mm 6 x Divisorio a 2 canali 3 x Divisorio a 3 canali	21,30



ART.	adatto per cassetto H mm	componenti	€
FFH84050400	50/300	18 x Divisorio trasversale L=73 mm 9 x Divisorio a 2 canali	20,40



ART.	adatto per cassetto H mm	componenti	€
FFH84050800	50	2 x Divisorio longitudinale fessurato L=457 mm 3 x Divisorio trasversale L=151 mm	8,70
FFH84070800	75		12,60
FFH84100800	100/125		15,30
FFH84150800	150/175		19,80
FFH84200800	200/250		28,80
FFH84300800	300		37,50



ART.	adatto per cassetto H mm	componenti	€
FFH84050900	50	2 x Divisorio longitudinale fessurato L=457 mm 7 x Divisorio trasversale L=151 mm	11,40
FFH84070900	75		10,50
FFH84100900	100/125		13,80
FFH84150900	150/175		18,90
FFH84200900	200/250		29,70



ART.	adatto per cassetto H mm	componenti	€
FFH84051300	50	2 x Divisorio longitudinale non fessurato L=457 mm	8,10
FFH84071300	75		8,10
FFH84101300	100/125		8,70
FFH84151300	150/175		11,10
FFH84201300	200/250		12,90



## Materiale di separazione



ART.	adatto per cassetto H mm	componenti	€
FFH84051700	50	8 x Cassetta divisorio 75x75 mm	15,60
FFH84071700	75	6 x Cassetta divisorio 150x75 mm 4 x Cassetta divisorio 150x150 mm	19,80



ART.	adatto per cassetto H mm	componenti	€
FFH84051800	50	6 x Cassetta divisorio 150x75 mm 6 x Cassetta divisorio 150x150 mm	14,10
FFH84071800	75		21,90
FFH84101800	100/125		24,00

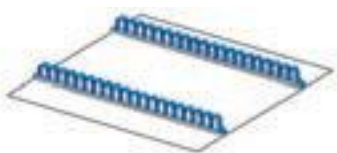

ART.	adatto per cassetto H mm	componenti	€
FFH86051900	50/300	2 x Portautensili multiuso	18,60





## Materiale di separazione



ART.	adatto per cassetto H mm	componenti	€
FFH10051500	50/300	20 x Divisorio trasversale L=36 mm 20 x Divisorio trasversale L=47 mm 6 x Divisorio a 3 canali 5 x Divisorio a 4 canali 1 x Porta chiavi a brugola	30,00



ART.	adatto per cassetto H mm	componenti	€
FFH10051000	50/300	3 x Divisorio a 3 canali 9 x Divisorio a 4 canali 12 x Divisorio trasversale L=47 mm 36 x Divisorio trasversale L=36 mm	30,00



ART.	adatto per cassetto H mm	componenti	€
FFH10051300	50/300	18 x Divisorio trasversale L=47 mm 12 x Divisorio trasversale L=73 mm 6 x Divisorio a 2 canali 6 x Divisorio a 3 canali	27,00



ART.	adatto per cassetto H mm	componenti	€
FFH10052100	50/300	12 x Divisorio a 4 canali 65 x Divisorio trasversale L=36 mm	44,70



ART.	adatto per cassetto H mm	componenti	€
FFH10051600	50	12 x Cassetta divisorio 150x75 mm 6 x Cassetta divisorio 150x150 mm	19,20
FFH10071600	75		27,90
FFH10101600	100/125		32,70



ART.	adatto per cassetto H mm	componenti	€
FFH10051800	50	16 x Cassetta divisorio 75x75 mm 8 x Cassetta divisorio 150x75 mm 4 x Cassetta divisorio 150x150 mm	21,90
FFH10071800	75		30,60





## Materiale di separazione



ART.	adatto per cassetto H mm	componenti	€
FFH10050500	50	2 x Divisorio longitudinale fessurato L=457 mm 3 x Divisorio trasversale L=202 mm	9,60
FFH10070500	75		15,30
FFH10100500	100/125		15,90
FFH10150500	150/175		21,30
FFH10200500	200/250		30,30
FFH10300500	300		41,70



ART.	adatto per cassetto H mm	componenti	€
FFH10050300	50	3 x Divisorio longitudinale fessurato L=457 mm 8 x Divisorio trasversale L=151 mm	15,30
FFH10070300	75		13,80
FFH10100300	100/125		18,60
FFH10150300	150/175		25,50
FFH10200300	200/250		40,80



ART.	adatto per cassetto H mm	componenti	€
FFH10052200	50	5 x Divisorio longitudinale fessurato L=457 mm 18 x Divisorio trasversale L=100 mm	30,30
FFH10072200	75		30,30
FFH10102200	100/125		40,20
FFH10152200	150/175		53,10



ART.	adatto per cassetto H mm	componenti	€
FFH84051300	50	2 x Divisorio longitudinale non fessurato L=457 mm	8,10
FFH84071300	75		8,10
FFH84101300	100/125		8,70
FFH84151300	150/175		11,10
FFH84201300	200/250		12,90





## Materiale di separazione



ART.	adatto per cassetto H mm	componenti	€
FFH40051200	50/300	15 x Divisorio trasversale L=36 mm 10 x Divisorio trasversale L=47 mm 6 x Divisorio trasversale L=73 mm 6 x Divisorio a 2 canali 6 x Divisorio a 3 canali 6 x Divisorio a 4 canali	37,20



ART.	adatto per cassetto H mm	componenti	€
FFH40051500	50/300	30 x Divisorio trasversale L=36 mm 10 x Divisorio trasversale L=47 mm 6 x Divisorio a 3 canali 12 x Divisorio a 4 canali	39,60



ART.	adatto per cassetto H mm	componenti	€
FFH40051100	50	18 x Cassetta divisorio 150x150 mm	26,70
FFH40071100	75		39,90
FFH40101100	100/125		45,00



ART.	adatto per cassetto H mm	componenti	€
FFH40051300	50	12 x Cassetta divisorio 150x75 mm 12 x Cassetta divisorio 150x150 mm	28,20
FFH40071300	75		41,70
FFH40101300	100/125		48,00



ART.	adatto per cassetto H mm	componenti	€
FFH40051600	50	20 x Cassetta divisorio 75x75 mm 14 x Cassetta divisorio 150x75 mm 6 x Cassetta divisorio 150x150 mm	32,40
FFH40071600	75		45,90

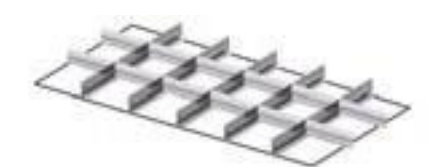

ART.	adatto per cassetto H mm	componenti	€
FFH40050300	50	5 x Divisorio longitudinale fessurato L=457 mm 12 x Divisorio trasversale L=151 mm	24,30
FFH40070300	75		22,50
FFH40100300	100/125		30,00
FFH40150300	150/175		41,10
FFH40200300	200/250		66,00





## Materiale di separazione

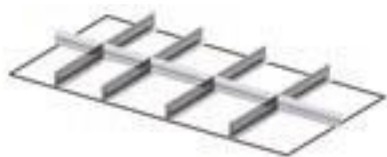

ART.	adatto per cassetto H mm	componenti	€
FFH40050500	50	4 x Divisorio longitudinale fessurato L=457 mm 2 x Divisorio trasversale L=151 mm 3 x Divisorio trasversale L=202 mm	17,40
FFH40070500	75		22,80
FFH40100500	100/125		26,10
FFH40150500	150/175		38,10
FFH40200500	200/250		55,80



ART.	adatto per cassetto H mm	componenti	€
FFH40052000	50	2 x Divisorio longitudinale fessurato L=457 mm 2 x Divisorio trasversale L=304 mm	9,60
FFH40072000	75		10,20
FFH40102000	100/125		13,20
FFH40152000	150/175		17,40
FFH40202000	200/250		25,80
FFH40302000	300		43,80

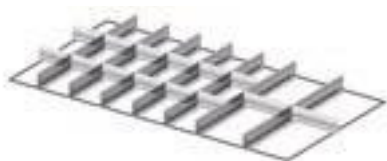

ART.	adatto per cassetto H mm	componenti	€
FFH40050600	50	7 x Divisorio longitudinale fessurato L=457 mm 12 x Divisorio trasversale L=100 mm 2 x Divisorio trasversale L=151 mm	35,70
FFH40070600	75		36,30
FFH40100600	100/125		46,80





## Materiale di separazione



ART.	adatto per cassetto H mm	componenti	€
FFH86050100	50/300	50 x Divisorio trasversale L=36 mm 12 x Divisorio a 4 canali	25,80



ART.	adatto per cassetto H mm	componenti	€
FFH86050200	50/300	4 x Divisorio a 4 canali 8 x Divisorio a 3 canali 20 x Divisorio trasversale L=36 mm 10 x Divisorio trasversale L=47 mm	31,80



ART.	adatto per cassetto H mm	componenti	€
FFH86050300	50/300	4 x Divisorio a 3 canali 8 x Divisorio a 2 canali 20 x Divisorio trasversale L=47 mm 10 x Divisorio trasversale L=73 mm	30,60



ART.	adatto per cassetto H mm	componenti	€
FFH86051600	50	16 x Cassetta divisorio con divisorio fisso 75x75 mm	23,70
FFH86071600	75	16 x Cassetta divisorio 75x75 mm 4 x Cassetta divisorio 150x75 mm	27,30



ART.	adatto per cassetto H mm	componenti	€
FFH86051700	50	16 x Cassetta divisorio 75x75 mm 8 x Cassetta divisorio 150x75 mm	21,90
FFH86071700	75	4 x Cassetta divisorio 150x150 mm	27,30



ART.	adatto per cassetto H mm	componenti	€
FFH86051800	50	12 x Cassetta divisorio 150x75 mm 6 x Cassetta divisorio 150x150 mm	19,20
FFH86071800	75		24,60
FFH86101800	100/125		28,20



**Materiale di separazione**



ART.	adatto per cassetto H mm	componenti	€
FFH86050700	50	1 x Divisorio longitudinale fessurato L=610 mm 1 x Divisorio trasversale L=202 mm 1 x Divisorio trasversale L=253 mm	6,30
FFH86070700	75		5,40
FFH86100700	100/125		6,60
FFH86150700	150/175		9,60
FFH86200700	200/250		15,00
FFH86300700	300		33,60



ART.	adatto per cassetto H mm	componenti	€
FFH86050800	50	2 x Divisorio longitudinale fessurato L=610 mm 3 x Divisorio trasversale L=151 mm	9,60
FFH86070800	75		8,10
FFH86100800	100/125		10,20
FFH86150800	150/175		14,70
FFH86200800	200/250		22,50
FFH86300800	300		51,00



ART.	adatto per cassetto H mm	componenti	€
FFH86050900	50	2 x Divisorio longitudinale fessurato L=610 mm 10 x Divisorio trasversale L=151 mm	14,10
FFH86070900	75		12,60
FFH86100900	100/125		15,60
FFH86150900	150/175		22,50
FFH86200900	200/250		33,90



ART.	adatto per cassetto H mm	componenti	€
FFH86051000	50	3 x Divisorio longitudinale fessurato L=610 mm 6 x Divisorio trasversale L=100 mm 2 x Divisorio trasversale L=151 mm	16,20
FFH86071000	75		13,80
FFH86101000	100/125		17,40
FFH86151000	150/175		24,90



ART.	adatto per cassetto H mm	componenti	€
FFH86051300	50	2 x Divisorio longitudinale non fessurato L=610 mm	9,60
FFH86071300	75		8,40
FFH86101300	100/125		9,60
FFH86151300	150/175		12,30
FFH86201300	200/250		15,30
FFH86301300	300		19,80

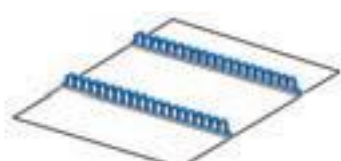

ART.	adatto per cassetto H mm	componenti	€
FFH86051900	50/300	2 x Portautensili multiuso	18,60



## Materiale di separazione



ART.	adatto per cassetto H mm	componenti	€
FFH20051500	50/300	35 x Divisorio trasversale L=73 mm 16 x Divisorio a 2 canali	33,30



ART.	adatto per cassetto H mm	componenti	€
FFH20051600	50/300	50 x Divisorio trasversale L=47 mm 16 x Divisorio a 3 canali	35,40



ART.	adatto per cassetto H mm	componenti	€
FFH20051700	50/300	65 x Divisorio trasversale L=36 mm 16 x Divisorio a 4 canali	38,70



ART.	adatto per cassetto H mm	componenti	€
FFH20052000	50/300	30 x Divisorio trasversale L=36 mm 20 x Divisorio trasversale L=47 mm 10 x Divisorio trasversale L=73 mm 4 x Divisorio a 2 canali 8 x Divisorio a 3 canali 4 x Divisorio a 4 canali	31,80



ART.	adatto per cassetto H mm	componenti	€
FFH20052100	50/300	8 x Divisorio a 3 canali 8 x Divisorio a 4 canali 16 x Divisorio trasversale L=47 mm 24 x Divisorio trasversale L=36 mm	43,20



ART.	adatto per cassetto H mm	componenti	€
FFH20051200	50	16 x Cassetta divisorio 75x75 mm 16 x Cassetta divisorio 150x75 mm	30,60
FFH20071200	75	4 x Cassetta divisorio 150x150 mm	40,50



## Materiale di separazione



ART.	adatto per cassetto H mm	componenti	€
FFH20051300	50	16 x Cassetta divisorio 150x75 mm 8 x Cassetta divisorio 150x150 mm	26,70
FFH20071300	75		36,60
FFH20101300	100/125		42,90



ART.	adatto per cassetto H mm	componenti	€
FFH20050500	50	1 x Divisorio longitudinale fessurato L=610 mm 2 x Divisorio trasversale L=304 mm	6,00
FFH20070500	75		6,00
FFH20100500	100/125		7,20
FFH20150500	150/175		9,90
FFH20200500	200/250		14,40
FFH20300500	300		29,70



ART.	adatto per cassetto H mm	componenti	€
FFH20050600	50	2 x Divisorio longitudinale fessurato L=610 mm 3 x Divisorio trasversale L=202 mm	11,70
FFH20070600	75		14,70
FFH20100600	100/125		16,50
FFH20150600	150/175		22,50
FFH20200600	200/250		34,20
FFH20300600	300		60,00



ART.	adatto per cassetto H mm	componenti	€
FFH20050700	50	3 x Divisorio longitudinale fessurato L=610 mm 15 x Divisorio trasversale L=151 mm	21,00
FFH20070700	75		18,60
FFH20100700	100/125		23,40
FFH20150700	150/175		33,30
FFH20200700	200/250		50,70



ART.	adatto per cassetto H mm	componenti	€
FFH20050800	50	4 x Divisorio longitudinale fessurato L=610 mm 9 x Divisorio trasversale L=151 mm 12 x Divisorio trasversale L=100 mm	29,40
FFH20070800	75		28,50
FFH20100800	100/125		38,40



ART.	adatto per cassetto H mm	componenti	€
FFH20050900	50	5 x Divisorio longitudinale fessurato L=610 mm 20 x Divisorio trasversale L=100 mm	33,00
FFH20070900	75		28,50
FFH20100900	100/125		39,00
FFH20150900	150/175		54,00





## Materiale di separazione



ART.	adatto per cassetto H mm	componenti	€
FFH30051000	50/300	130 x Divisorio trasversale L=36 mm 20 x Divisorio a 4 canali	46,20



ART.	adatto per cassetto H mm	componenti	€
FFH30051200	50/300	100 x Divisorio trasversale L=47 mm 20 x Divisorio a 3 canali	43,80



ART.	adatto per cassetto H mm	componenti	€
FFH30050700	50	20 x Cassetta divisorio 75x75 mm	36,00
FFH30070700	75	20 x Cassetta divisorio 150x75 mm 5 x Cassetta divisorio 150x150 mm	45,00



ART.	adatto per cassetto H mm	componenti	€
FFH30050800	50	20 x Cassetta divisorio 150x75 mm 10 x Cassetta divisorio 150x150 mm	31,80
FFH30070800	75		41,10
FFH30100800	100/125		46,80



ART.	adatto per cassetto H mm	componenti	€
FFH30050900	50	20 x Cassetta divisorio 150x150 mm	29,70
FFH30070900	75		38,10
FFH30100900	100/125		41,70



ART.	adatto per cassetto H mm	componenti	€
FFH30100200	100/125	2 x Divisorio longitudinale fessurato L=610 mm 8 x Divisorio trasversale L=253 mm	17,70
FFH30150200	150/175		26,10
FFH30200200	200/250		36,90
FFH30300200	300		72,60





## Materiale di separazione



ART.	adatto per cassetto H mm	componenti	€
FFH30070300	75	4 x Divisorio longitudinale fessurato L=610 mm 21 x Divisorio trasversale L=151 mm	25,50
FFH30100300	100/125		31,80
FFH30150300	150/175		45,60
FFH30200300	200/250		69,00
FFH30300300	300		135,30

ART.	adatto per cassetto H mm	componenti	€
FFH30070400	75	3 x Divisorio longitudinale fessurato L=610 mm 5 x Divisorio trasversale L=151 mm 10 x Divisorio trasversale L=202 mm	23,40
FFH30100400	100/125		30,60
FFH30150400	150/175		39,00
FFH30200400	200/250		64,20
FFH30300400	300		125,70





## Materiale di separazione

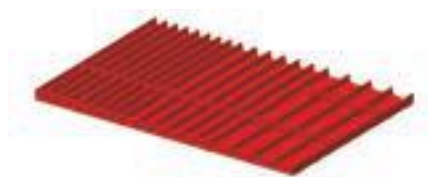

ART.	adatto per cassetto H mm	componenti	€
FFH50050900	50/300	15 x Divisorio trasversale L=36 mm 10 x Divisorio trasversale L=47 mm 6 x Divisorio trasversale L=73 mm 8 x Divisorio a 2 canali 8 x Divisorio a 3 canali 8 x Divisorio a 4 canali	42,30



ART.	adatto per cassetto H mm	componenti	€
FFH50051900	50/300	30 x Divisorio trasversale L=36 mm 10 x Divisorio trasversale L=47 mm 8 x Divisorio a 3 canali 16 x Divisorio a 4 canali	47,10



ART.	adatto per cassetto H mm	componenti	€
FFH50050800	50	12 x Cassetta divisorio 150x75 mm 18 x Cassetta divisorio 150x150 mm	38,40
FFH50070800	75		51,90
FFH50100800	100/125		58,20



ART.	adatto per cassetto H mm	componenti	€
FFH50051700	50	20 x Cassetta divisorio 75x75 mm 14 x Cassetta divisorio 150x75 mm 12 x Cassetta divisorio 150x150 mm	42,60
FFH50071700	75		56,10



ART.	adatto per cassetto H mm	componenti	€
FFH50051800	50	24 x Cassetta divisorio 150x150 mm	36,90
FFH50071800	75		50,10
FFH50101800	100/125		55,20



ART.	adatto per cassetto H mm	componenti	€
FFH50050700	50	4 x Divisorio longitudinale fessurato L=610 mm 2 x Divisorio trasversale L=151 mm 3 x Divisorio trasversale L=202 mm	21,00
FFH50070700	75		16,20
FFH50100700	100/125		19,80
FFH50150700	150/175		29,10
FFH50200700	200/250		51,90
FFH50300700	300		116,70



## Materiale di separazione



ART.	adatto per cassetto H mm	componenti	€
FFH50051000	50	2 x Divisorio longitudinale fessurato L=610 mm 2 x Divisorio trasversale L=304 mm	10,20
FFH50071000	75		9,00
FFH50101000	100/125		12,00
FFH50151000	150/175		16,80
FFH50201000	200/250		25,80
FFH50301000	300		61,80



ART.	adatto per cassetto H mm	componenti	€
FFH50051300	50	5 x Divisorio longitudinale fessurato L=610 mm 12 x Divisorio trasversale L=151 mm	28,80
FFH50071300	75		23,40
FFH50101300	100/125		29,10
FFH50151300	150/175		42,30
FFH50201300	200/250		73,20
FFH50301300	300		156,90



ART.	adatto per cassetto H mm	componenti	€
FFH50051500	50	7 x Divisorio longitudinale fessurato L=610 mm 12 x Divisorio trasversale L=100 mm 2 x Divisorio trasversale L=151 mm	34,80
FFH50071500	75		29,40
FFH50101500	100/125		37,20







## Materiale di separazione



ART.	adatto per cassetto H mm	componenti	€
FFH60070200	75	4 x Divisorio longitudinale fessurato L=610 mm 3 x Divisorio trasversale L=151 mm 3 x Divisorio trasversale L=168 mm 9 x Divisorio trasversale L=253 mm	27,30
FFH60100200	100/125		32,70
FFH60150200	150/175		47,10
FFH60200200	200/250		66,90



ART.	adatto per cassetto H mm	componenti	€
FFH60070500	75	5 x Divisorio longitudinale fessurato L=610 mm 6 x Divisorio trasversale L=134 mm 9 x Divisorio trasversale L=202 mm	27,90
FFH60100500	100/125		33,90
FFH60150500	150/175		48,90



ART.	adatto per cassetto H mm	componenti	€
FFH60070800	75	5 x Divisorio longitudinale fessurato L=610 mm 2 x Divisorio trasversale L=151 mm 1 x Divisorio trasversale L=168 mm 3 x Divisorio trasversale L=202 mm	20,10
FFH60100800	100/125		25,50
FFH60150800	150/175		36,30
FFH60200800	200/250		55,50
FFH60300800	300		124,80



ART.	adatto per cassetto H mm	componenti	€
FFH60071100	75	6 x Divisorio longitudinale fessurato L=610 mm 6 x Divisorio trasversale L=151 mm 1 x Divisorio trasversale L=168 mm	23,40
FFH60101100	100/125		29,70
FFH60151100	150/175		42,00
FFH60201100	200/250		64,50
FFH60301100	300		146,10





## Materiale di separazione



ART.	adatto per cassetto H mm	componenti	€
FFH70070200	75		29,70
FFH70100200	100/125	5 x Divisorio longitudinale fessurato L=610 mm 6 x Divisorio trasversale L=151 mm 9 x Divisorio trasversale L=253 mm	35,40
FFH70150200	150/175		51,30
FFH70200200	200/250		75,30



ART.	adatto per cassetto H mm	componenti	€
FFH70070300	75	6 x Divisorio longitudinale fessurato L=610 mm 3 x Divisorio trasversale L=134 mm 3 x Divisorio trasversale L=168 mm 14 x Divisorio trasversale L=202 mm	35,10
FFH70100300	100/125		42,90
FFH70150300	150/175		62,40

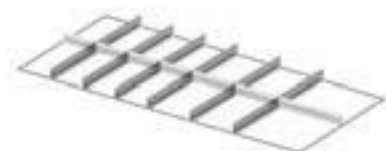

ART.	adatto per cassetto H mm	componenti	€
FFH70070700	75	6 x Divisorio longitudinale fessurato L=610 mm 4 x Divisorio trasversale L=151 mm 2 x Divisorio trasversale L=202 mm 1 x Divisorio trasversale L=304 mm	24,30
FFH70100700	100/125		30,30
FFH70150700	150/175		43,20
FFH70200700	200/250		66,60
FFH70300700	300		150,30



ART.	adatto per cassetto H mm	componenti	€
FFH70070800	75	5 x Divisorio longitudinale fessurato L=610 mm 2 x Divisorio trasversale L=151 mm 2 x Divisorio trasversale L=202 mm 2 x Divisorio trasversale L=304 mm	21,30
FFH70100800	100/125		26,40
FFH70150800	150/175		37,50
FFH70200800	200/250		57,30
FFH70300800	300		129,30



# MASTER CS

POSTAZIONE PC

# STANDARD CS

POSTAZIONE PC

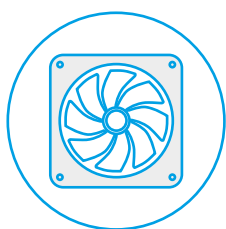

**Ventilazione forzata**

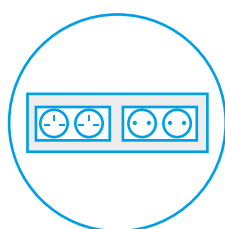

**Impianto elettrico con  
prese DE CH GB FR**

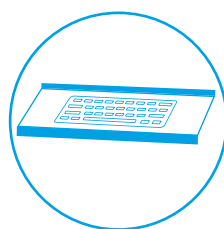

**Piano per tastiera  
estraibile**

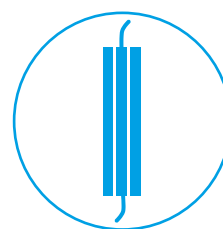

**Canaletta per  
gestione passaggio  
cavi**



# ARMADI PORTA COMPUTER

## MASTER CS

1. Porta con serratura di sicurezza e vetro in policarbonato. Dimensioni utili: 655x215x465 mm H.
2. Possibilità di inserimento video fino a 21". Dimensioni interne del vano superiore: 710x215x530 mm H.
3. Cassetto estraibile con piano porta tastiera e 2 posizioni di bloccaggio, in apertura spazio posteriore per contenimento oggetti. Dimensioni utili: 655x465 mm H.
4. Vano con possibilità di inserimento di piani estraibili e piani regolabili in altezza, per l'alloggiamento di sistemi hardware e stampanti. Larghezza inserimento utile: 663 mm. Altezza utile: 754 mm.
5. Foro per cavi di rete e foro di uscita del cavo per l'impianto elettrico.
6. Foro di entrata dell'aria con filtro antipolvere.
7. Impianto elettrico a 4 prese Schuko.
8. Canalette porta cavi a 4 corsie.
9. Ventola di raffreddamento con filtro antipolvere.
10. Piano estraibile. Dimensioni: 602x449 mm.
11. Piano regolabile. Dimensioni 663x560x52 mm H.



Armadio acquistabile senza il modulo superiore. Ottimo per soluzioni con computer portatili e schermi touch screen.



## STANDARD CS

12. Porta con serratura di sicurezza e vetro in policarbonato. Dimensioni utili: 661x525 mm H.
13. Possibilità di inserimento video fino a 21". Dimensioni interne del vano superiore: 690x600x580 mm H.
14. Piano porta tastiera. Dimensioni utili: 620x510 mm H.
15. Vano inferiore con possibilità di inserimento di piani estraibili e piani regolabili in altezza, per l'alloggiamento di sistemi hardware e stampanti. Dimensioni interne: 690x600x720 mm H.
16. Foro per cavi di rete e foro di uscita del cavo per l'impianto elettrico.
17. Foro di entrata dell'aria con filtro antipolvere.
18. Impianto elettrico a 4 prese Schuko.
19. Canalette porta cavi a 4 corsie.
20. Ventola di raffreddamento con filtro antipolvere.
21. Piano estraibile. Dimensioni: 650x582x36 mm H.
22. Piano regolabile. Dimensioni 688x591x38 mm H.





### Armadio porta computer con ruote

ART.	L mm	P mm	H mm	set ruote	RAL	€
MASTERC01	792	617	1731	450	7035	1329,00

Composto da:

qtà	descrizione
1	Armadio inferiore con 1 cassetto
1	Armadio superiore con porta in policarbonato
1	Maniglia a tubo
1	Piano estraibile a estrazione flessibile con maniglia Dark Grey
1	Supporto presa
1	Multipresa schuko a 4 scomparti
1	Cavo di collegamento wieland schuko/francese
1	Ventola 230 V senza griglia con spina Schuko
1	Kit ruote in nylon Ø 100 mm



### Armadio superiore con porta in policarbonato

ART.	L mm	P mm	H mm	RAL	€
FAS1450C01008	714	247	650	7035	278,10

Possibilità di inserimento video fino a 24"



### Armadio superiore con tapparella

ART.	L mm	P mm	H mm	RAL	€
FAS1450C02008	714	247	650	7035	309,00

Possibilità di inserimento video fino a 24"



### Armadio inferiore con 1 cassetto

ART.	L mm	P mm	H mm		n. cassette	n. piani porta tastiera	n. piani regolabili	RAL	€
FAS1400C00508	714	598	950	200	1	1	1	7035	812,70



piano porta tastiera

## Kit ruote



ART.	Ø mm	KG	KG	H mm	materiale				€
FKRU1252101	125	100	300	155	Gomma antitraccia sintetica	-	2	2	53,40
FKRV1001107	100	150	450	128	Nylon	1	1	2	46,20



RUOTA GIREVOLE



RUOTA GIREVOLE CON FRENO



RUOTA FISSA



## Piano estraibile a estrazione flessibile con maniglia Dark Grey 36x27 EH

ART.	dim. utili		RAL	€
	L mm	P mm		
M32C05701101F39	602	449	7016	96,60



## Maniglia a tubo

ART.	L mm	P mm	H mm	RAL	€
M02R00000000007	484	80	46	9005	12,60



## Piano regolabile con supporti 36x27 EH

ART.	L mm	P mm	H mm	RAL	€
M32PR2500001139	663	560	52	7016	57,30



## Ventola 230 V senza griglia con spina Schuko

ART.	L mm	P mm	H mm	colore	€
FAS32200100	125	44	125	Nero	30,00



## Top a 3 bordi rivestito in pvc con foro passacavi 36x27 EH

ART.	L mm	P mm	H mm	colore	€
M32T023AG007107	715	576	31	Nero	60,00



## Supporto presa

ART.	L mm	P mm	H mm	finitura	€
FAS30210099	542	10	77	Zincato	9,30

## Esempi schema multiprese su Supporto presa

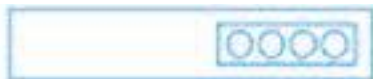

Con multipresa a 4 scomparti



Con multipresa a 2 scomparti + multipresa a 4 scomparti



Con magnetotermico + multipresa a 4 scomparti



vedi pag. 96



FBLET012007



FBLET004007



FBLET005007



FBLET016007





### Armadio porta computer con ruote

ART.	L mm	P mm	H mm	set ruote	RAL	€
STANDARDCS01	807	654	1688	450	7035	892,80

### Composto da:

qtà	descrizione
1	Armadio porta computer
1	Maniglia a tubo
1	Supporto presa
1	Piano estraibile a estrazione semplice
1	Multipresa schuko a 4 scomparti
1	Cavo di collegamento wieland schuko/francese
1	Ventola 230 V senza griglia con spina Schuko
1	Kit ruote in nylon Ø 100 mm



### Armadio porta computer

ART.	L mm	P mm	H mm		n. piani porta tastiera	n. piani regolabili	RAL	€
FAS1600C00208	717	635	1560	400	1	2	7035	679,80
FAS1600C00204	717	635	1560	400	1	2	5012	679,80

## Kit ruote



ART.	Ø mm	KG	KG	H mm	materiale				€
FKRU1252101	125	100	300	155	Gomma antitraccia sintetica	-	2	2	53,40
FKRV1001107	100	150	450	128	Nylon	1	1	2	46,20



RUOTA GIREVOLE



RUOTA GIREVOLE CON FRENO



RUOTA FISSA



## Piano estraibile a estrazione semplice

ART.	L mm	P mm	H mm	RAL	€
FAS2360S039	650	582	36	7016	68,70



## Piano regolabile con ganci

ART.	L mm	P mm	H mm	RAL	€
FAS2040S139	688	591	38	7016	54,60



## Maniglia a tubo

ART.	L mm	P mm	H mm	RAL	€
FCL09950007	502	80	46	9005	15,30



## Ventola 230 V senza griglia con spina Schuko

ART.	L mm	P mm	H mm	colore	€
FAS32200100	125	44	125	Nero	30,00



## Coppia zoccoli

ART.	L mm	P mm	H mm	RAL	€
FRR16250007	59	608	100	9005	44,40



## Supporto presa

ART.	L mm	P mm	H mm	finitura	€
FAS30210099	542	10	77	Zincato	9,30

## Esempi schema multiprese su Supporto presa



Con multipresa a 4 scomparti



Con multipresa a 2 scomparti + multipresa a 4 scomparti



Con magnetotermico + multipresa a 4 scomparti

# IRON TEAM

vedi pag. 96



FBLET012007



FBLET004007



FBLET005007



FBLET016007



ZINCATO



RAL 5012



RAL 7035



RAL 7016



RAL 9005



PORTATA

# PERFOM

## ARMADI A PORTE BATTENTE



**Configurabile**



**Portata 800/1200  
kg**

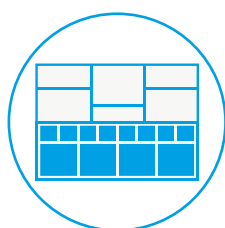

**Materiale di  
separazione**



**Chiusura a chiave**

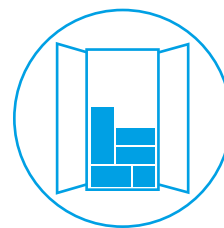

**Armadio montato +  
accessori  
confezionati  
all'interno**





ART.	L mm	P mm	H mm		RAL	€
<b>PERFOM15001</b>	1193	555	1000	800	7035+7016	471,60
<b>PERFOM15002</b>	1193	555	1000	800	7035	471,60
<b>PERFOM15003</b>	1193	555	1000	800	5012	471,60

Composto da:

qtà	descrizione
1	Armadio con porte a battente
1	Kit 2 piani fessurati



ART.	L mm	P mm	H mm		RAL	€
<b>PERFOM15004</b>	1193	555	1000	800	7035+7016	595,20
<b>PERFOM15005</b>	1193	555	1000	800	7035	595,20
<b>PERFOM15006</b>	1193	555	1000	800	5012	595,20

Composto da:

qtà	descrizione
1	Armadio con porte a battente
1	Cassetto a estrazione telescopica H=100 mm
1	Kit 2 piani fessurati



ART.	L mm	P mm	H mm		RAL	€
<b>PERFOM15007</b>	1193	555	1000	800	7035+7016	718,80
<b>PERFOM15008</b>	1193	555	1000	800	7035	718,80
<b>PERFOM15009</b>	1193	555	1000	800	5012	718,80

Composto da:

qtà	descrizione
1	Armadio con porte a battente
2	Cassetto a estrazione telescopica H=100 mm
1	Kit 2 piani fessurati



ART.	L mm	P mm	H mm		RAL	€
<b>PERFOM15010</b>	1193	555	1000	800	7035+7016	814,50
<b>PERFOM15011</b>	1193	555	1000	800	7035	814,50
<b>PERFOM15012</b>	1193	555	1000	800	5012	814,50

Composto da:

qtà	descrizione
1	Armadio con porte a battente
3	Cassetto a estrazione telescopica H=100 mm
1	Piano fessurato



RAL 5012



RAL 7035



RAL 7035 + RAL 7016



PORTATA



ART.	L mm	P mm	H mm		RAL	€
<b>PERFOM17001</b>	1193	555	2000	1200	7035+7016	612,90
<b>PERFOM17002</b>	1193	555	2000	1200	7035	612,90
<b>PERFOM17003</b>	1193	555	2000	1200	5012	612,90

Composto da:

qtà	descrizione
1	Armadio con porte a battente
2	Kit 2 piani fessurati



ART.	L mm	P mm	H mm		RAL	€
<b>PERFOM17004</b>	1193	555	2000	1200	7035+7016	983,70
<b>PERFOM17005</b>	1193	555	2000	1200	7035	983,70
<b>PERFOM17006</b>	1193	555	2000	1200	5012	983,70

Composto da:

qtà	descrizione
1	Armadio con porte a battente
3	Cassetto a estrazione telescopica H=100 mm
2	Kit 2 piani fessurati



ART.	L mm	P mm	H mm		RAL	€
<b>PERFOM17007</b>	1193	555	2000	1200	7035+7016	1668,00
<b>PERFOM17008</b>	1193	555	2000	1200	7035	1668,00
<b>PERFOM17009</b>	1193	555	2000	1200	5012	1668,00

Composto da:

qtà	descrizione
1	Armadio con porte a battente
9	Cassetto a estrazione telescopica H=100 mm
1	Kit 2 piani fessurati



ART.	L mm	P mm	H mm		RAL	€
PERFOM11001	512	555	1000	800	7035+7016	264,60
FAA1120C00108	512	555	1000	800	7035	264,60
FAA1120C00104	512	555	1000	800	5012	264,60

Composto da:

qtà	descrizione
1	Armadio con porta a battente
1	Kit 2 piani fessurati



ART.	L mm	P mm	H mm		RAL	€
PERFOM11004	512	555	1000	800	7035+7016	324,60
PERFOM11005	512	555	1000	800	7035	324,60
PERFOM11006	512	555	1000	800	5012	324,60

Composto da:

qtà	descrizione
1	Armadio con porta a battente
1	Cassetto a estrazione semplice H=100 mm
1	Kit 2 piani fessurati



ART.	L mm	P mm	H mm		RAL	€
PERFOM11010	512	555	1000	800	1004	330,90
PERFOM11011	512	555	1000	800	7035+7016	330,90
PERFOM11012	512	555	1000	800	7035	330,90
PERFOM11013	512	555	1000	800	5012	330,90

Composto da:

qtà	descrizione
1	Armadio con porta a battente fessurata
1	Kit 2 vasche stagne interne di raccolta liquidi capacità 9 L



vedi pag. 256



ART.	L mm	P mm	H mm	 set ruote	RAL	€
PERFOM11017	519	555	1409	225	7035+7016	526,80
PERFOM11018	519	555	1409	225	7035	516,60
PERFOM11019	519	555	1409	225	5012	516,60

Composto da:

qtà	descrizione
1	Armadio con porta a battente
1	Leggio
1	Cassetto a estrazione semplice H=100 mm
1	Kit 2 piani fessurati
1	Coppia piastre portaruote
1	Kit ruote in gomma standard Ø 100 mm



ART.	L mm	P mm	H mm	KG	RAL	€
<b>PERFOM12001</b>	1023	555	1000	800	7035+7016	382,50
<b>FAA1220C00108</b>	1023	555	1000	800	7035	382,50
<b>FAA1220C00104</b>	1023	555	1000	800	5012	382,50

Composto da:

qtà	descrizione
1	Armadio con porte a battente
1	Kit 2 piani fessurati



ART.	L mm	P mm	H mm	KG	RAL	€
<b>PERFOM12004</b>	1023	555	1000	800	7035+7016	453,60
<b>PERFOM12005</b>	1023	555	1000	800	7035	453,60
<b>PERFOM12006</b>	1023	555	1000	800	5012	453,60

Composto da:

qtà	descrizione
1	Armadio con porte a battente
1	Cassetto a estrazione semplice H=100 mm
1	Kit 2 piani fessurati



ART.	L mm	P mm	H mm	KG	RAL	€
<b>PERFOM12007</b>	1023	555	1000	800	7035+7016	573,00
<b>PERFOM12008</b>	1023	555	1000	800	7035	573,00
<b>PERFOM12009</b>	1023	555	1000	800	5012	573,00

Composto da:

qtà	descrizione
1	Armadio con porte a battente
3	Cassetto a estrazione semplice H=100 mm
1	Piano fessurato



ART.	L mm	P mm	H mm	KG	RAL	€
<b>PERFOM12010</b>	1023	555	1000	800	7035+7016	711,30
<b>PERFOM12011</b>	1023	555	1000	800	7035	711,30
<b>PERFOM12012</b>	1023	555	1000	800	5012	698,70

Composto da:

qtà	descrizione
1	Armadio con porte a battente fessurate
1	Kit 2 piani/pannelli forati
1	Canaletta elettrica per multiprese
2	Multipresa schuko a 2 scomparti
1	Multipresa schuko a 4 scomparti
1	Magnetotermico differenziale
1	Cavo di collegamento wieland schuko/francese





ART.	L mm	P mm	H mm	KG	RAL	€
PERFOM12013	1048	600	1027	800	1004	458,70
PERFOM12014	1048	600	1027	800	7035+7016	458,70
PERFOM12015	1048	600	1027	800	7035	458,70
PERFOM12016	1048	600	1027	800	5012	458,70

Composto da:

qtà	descrizione
1	Armadio con porte a battente fessurate
1	Piano fessurato
1	Vasca stagna esterna di raccolta liquidi capacità 59 L



vedi pag. 256



ART.	L mm	P mm	H mm	KG	RAL	€
PERFOM12017	1023	555	1000	800	1004	438,00
PERFOM12018	1023	555	1000	800	7035+7016	438,00
PERFOM12019	1023	555	1000	800	7035	438,00
PERFOM12020	1023	555	1000	800	5012	438,00

Composto da:

qtà	descrizione
1	Armadio con porte a battente fessurate
1	Kit 2 vasche stagne interne di raccolta liquidi capacità 19 L



vedi pag. 256



ART.	L mm	P mm	H mm	KG	RAL	€
PERFOM12025	1048	600	1027	800	6011	458,70

Composto da:

qtà	descrizione
1	Armadio con porte a battente fessurate
1	Piano fessurato
1	Vasca stagna esterna di raccolta liquidi capacità 59 L



vedi pag. 256



ART.	L mm	P mm	H mm	KG	RAL	€
PERFOM12021	1023	555	1000	800	3020	382,50
PERFOM12022	1023	555	1000	800	7035+7016	382,50
PERFOM12023	1023	555	1000	800	7035	382,50
PERFOM12024	1023	555	1000	800	5012	382,50

Composto da:

qtà	descrizione
1	Armadio con porte a battente fessurate
1	Kit 2 piani fessurati



RAL 6011



RAL 1004



RAL 3020



RAL 5012



RAL 7035



RAL 7035 + RAL 7016



PORTATA



ART.	L mm	P mm	H mm	KG	RAL	€
<b>PERFOM14001</b>	1023	555	2000	1200	7035+7016	505,50
<b>FAA1420C00108</b>	1023	555	2000	1200	7035	485,40
<b>FAA1420C00104</b>	1023	555	2000	1200	5012	485,40

Composto da:

qtà	descrizione
1	Armadio con porte a battente
1	Kit 4 piani fessurati



ART.	L mm	P mm	H mm	KG	RAL	€
<b>PERFOM14004</b>	1023	555	2000	1200	7035+7016	718,80
<b>PERFOM14005</b>	1023	555	2000	1200	7035	718,80
<b>PERFOM14006</b>	1023	555	2000	1200	5012	718,80

Composto da:

qtà	descrizione
1	Armadio con porte a battente
3	Cassetto a estrazione semplice H=100 mm
1	Kit 4 piani fessurati



ART.	L mm	P mm	H mm	KG	RAL	€
<b>PERFOM14007</b>	1023	555	2000	1200	7035+7016	631,20
<b>PERFOM14008</b>	1023	555	2000	1200	7035	631,20
<b>PERFOM14009</b>	1023	555	2000	1200	5012	631,20

Composto da:

qtà	descrizione
1	Armadio con porte a battente fessurate in policarbonato
1	Kit 4 piani fessurati





ART.	L mm	P mm	H mm	KG	RAL	€
PERFOM14019	1023	555	2000	1200	7035+7016	935,70
PERFOM14020	1023	555	2000	1200	7035	935,70
PERFOM14021	1023	555	2000	1200	5012	935,70

Composto da:

qtà	descrizione
1	Armadio con porte a battente fessurate
1	Vasca stagna interna di raccolta liquidi capacità 19 L
1	Kit piano fessurato con 2 separatori e 6 taniche con rubinetto a sfera
1	Kit 2 piani fessurati



ART.	L mm	P mm	H mm	KG	RAL	€
PERFOM14022	1048	600	2027	1200	7035+7016	1859,70
PERFOM14023	1048	600	2027	1200	7035	1859,70
PERFOM14024	1048	600	2027	1200	5012	1859,70

Composto da:

qtà	descrizione
1	Armadio con porte a battente fessurate
1	Vasca stagna interna di raccolta liquidi capacità 19 L
3	Kit piano fessurato con 2 separatori e 6 taniche con rubinetto a sfera
1	Piano fessurato
1	Vasca stagna esterna di raccolta liquidi capacità 59 L



RAL 5012



RAL 7035



RAL 7035 + RAL 7016



PORTATA



ART.	L mm	P mm	H mm	KG	RAL	€
<b>PERFOM14056</b>	1048	600	2027	1200	6011	582,00

Composto da:

qtà	descrizione
1	Armadio con porte a battente fessurate
1	Kit 3 piani fessurati
1	Vasca stagna esterna di raccolta liquidi capacità 59 L



vedi pag. 256



ART.	L mm	P mm	H mm	KG	RAL	€
<b>PERFOM14057</b>	1023	555	2000	1200	6011	618,30

Composto da:

qtà	descrizione
1	Armadio con porte a battente fessurate
2	Kit 2 vasche stagne interne di raccolta liquidi capacità 19 L



vedi pag. 256



ART.	L mm	P mm	H mm	KG	RAL	€
<b>PERFOM14058</b>	1023	555	2000	1200	7035	744,00

Composto da:

qtà	descrizione
1	Armadio con porte a battente fessurate in policarbonato
2	Kit 2 vasche stagne interne di raccolta liquidi capacità 19 L



vedi pag. 256



ART.	L mm	P mm	H mm	KG	RAL	€
PERFOM14025	1048	600	2027	1200	1004	582,00
PERFOM14026	1048	600	2027	1200	7035+7016	582,00
PERFOM14027	1048	600	2027	1200	7035	582,00
PERFOM14028	1048	600	2027	1200	5012	582,00

Composto da:

qtà	descrizione
1	Armadio con porte a battente fessurate
1	Kit 3 piani fessurati
1	Vasca stagna esterna di raccolta liquidi capacità 59 L



vedi pag. 256



ART.	L mm	P mm	H mm	KG	RAL	€
PERFOM14029	1023	555	2000	1200	1004	618,30
PERFOM14030	1023	555	2000	1200	7035+7016	618,30
PERFOM14031	1023	555	2000	1200	7035	618,30
PERFOM14032	1023	555	2000	1200	5012	618,30

Composto da:

qtà	descrizione
1	Armadio con porte a battente fessurate
2	Kit 2 vasche stagne interne di raccolta liquidi capacità 19 L



vedi pag. 256



ART.	L mm	P mm	H mm	RAL	€
PERFOM14033	1023	555	2000	3020	806,10

Composto da:

qtà	descrizione
1	Armadio con porte a battente fessurate safe crash
1	Kit 3 piani fessurati
1	Piano/pannello forato
1	Parete divisorio
1	Kit tubo appendiabiti



RAL 6011



RAL 1004



RAL 3020



RAL 5012



RAL 7035



RAL 7035 + RAL 7016



PORTATA



ART.	L mm	P mm	H mm	KG	RAL	€
PERFOM14034	1023	555	2000	1200	7035+7016	1275,90
PERFOM14035	1023	555	2000	1200	7035	1275,90
PERFOM14036	1023	555	2000	1200	5012	1250,70

Composto da:

qtà	descrizione
1	Armadio con porte a battente fessurate
2	Kit 2 piani/pannelli forati
2	Canaletta elettrica per multiprese
1	Griglia per ventole
2	Ventola 230 V senza griglia con spina Schuko
4	Multipresa schuko a 2 scomparti
3	Multipresa schuko a 4 scomparti

qtà	descrizione
1	Magnetotermico differenziale
1	Cavo di collegamento wieland con spine in/out
2	Cavo di collegamento wieland schuko/francese
1	Kit porta rotolo con carta Ø=240 mm
1	Gancio Unipok per utensili - confezione 30 pezzi
2	Mensola grande reversibile



ART.	L mm	P mm	H mm	KG	RAL	€
PERFOM14037	1023	555	2000	1200	7035+7016	1265,10
PERFOM14038	1023	555	2000	1200	7035	1265,10
PERFOM14039	1023	555	2000	1200	5012	1239,90

Composto da:

qtà	descrizione
1	Armadio con porte a battente fessurate in policarbonato
2	Kit 2 piani/pannelli forati
3	Canaletta elettrica per multiprese
6	Multipresa schuko a 2 scomparti
3	Multipresa schuko a 4 scomparti
1	Magnetotermico differenziale
2	Cavo di collegamento wieland con spine in/out
1	Cavo di collegamento wieland schuko/francese



ART.	L mm	P mm	H mm	KG	RAL	€
PERFOM14040	1023	555	2000	1200	7035+7016	1169,40
PERFOM14041	1023	555	2000	1200	7035	1169,40
PERFOM14042	1023	555	2000	1200	5012	1144,20

Composto da:

qtà	descrizione
1	Armadio con porte a battente fessurate
2	Kit 2 piani/pannelli forati
2	Canaletta elettrica per multiprese
2	Barra aggancio per contenitori Picking Box misura 1/2
6	Contenitore in polipropilene Picking Box misura 2
4	Multipresa schuko a 2 scomparti
2	Multipresa schuko a 4 scomparti
1	Magnetotermico differenziale
1	Cavo di collegamento wieland con spine in/out
1	Cavo di collegamento wieland schuko/francese
1	Kit porta rotolo con carta Ø=240 mm
2	Gancio Unipok per utensili - confezione 30 pezzi
2	Mensola grande reversibile



ART.	L mm	P mm	H mm	KG	RAL	€
PERFOM14043	1023	555	2000	1200	7035+7016	837,60
PERFOM14044	1023	555	2000	1200	7035	837,60
PERFOM14045	1023	555	2000	1200	5012	812,40

Composto da:

qtà	descrizione
1	Armadio con porte a battente fessurate
2	Kit 2 piani/pannelli forati
2	Canaletta elettrica per multiprese
2	Multipresa schuko a 2 scomparti
2	Multipresa schuko a 4 scomparti
1	Cavo di collegamento wieland con spine in/out
1	Cavo di collegamento wieland schuko/francese



RAL 5012



RAL 7035



RAL 7035 + RAL 7016



PORTATA



ART.	L mm	P mm	H mm	KG	RAL	€
<b>PERFOM14046</b>	1023	555	2000	1200	7035+7016	1274,40
<b>PERFOM14047</b>	1023	555	2000	1200	7035	1274,40
<b>PERFOM14048</b>	1023	555	2000	1200	5012	1249,20

Composto da:

qtà	descrizione
1	Armadio con porte a battente
3	Cassetto a estrazione semplice H=100 mm
2	Coppia pannelli forati per porta a battente
2	Kit 2 piani/pannelli forati
14	Barra aggancio per contenitori Picking Box misura 1/2
40	Contenitore in polipropilene Picking Box misura 1
12	Contenitore in polipropilene Picking Box misura 2
1	Kit porta rotolo con carta Ø=240 mm
4	Gancio Unipok per utensili - confezione 30 pezzi
2	Mensola grande reversibile



ART.	L mm	P mm	H mm	KG	RAL	€
<b>PERFOM14049</b>	1023	555	2000	1200	7035+7016	955,20
<b>PERFOM14050</b>	1023	555	2000	1200	7035	955,20
<b>PERFOM14051</b>	1023	555	2000	1200	5012	930,00

Composto da:

qtà	descrizione
1	Armadio con porte a battente
3	Cassetto a estrazione semplice H=100 mm
2	Kit 2 piani/pannelli forati
4	Barra aggancio per contenitori Picking Box misura 1/2
12	Contenitore in polipropilene Picking Box misura 2
4	Gancio Unipok per utensili - confezione 30 pezzi



ART.	L mm	P mm	H mm	KG	RAL	€
<b>PERFOM14052</b>	1023	555	2000	1200	7035+7016	1109,70
<b>PERFOM14053</b>	1023	555	2000	1200	7035	1109,70
<b>PERFOM14054</b>	1023	555	2000	1200	5012	1109,70

Composto da:

qtà	descrizione
1	Armadio con porte a battente
3	Cassetto a estrazione semplice H=100 mm
4	Cassetto a estrazione telescopica H=150 mm
1	Kit 2 piani fessurati





ART.	L mm	P mm	H mm	KG	RAL	€
PERFOM14010	1023	555	2000	1200	7035+7016	602,40
PERFOM14011	1023	555	2000	1200	7035	602,40
PERFOM14012	1023	555	2000	1200	5012	602,40

Composto da:

qtà	descrizione
1	Armadio con porte a battente fessurate
1	Kit 3 piani fessurati
1	Piano/pannello forato
1	Parete divisorio
1	Kit tubo appendiabiti



ART.	L mm	P mm	H mm	KG	RAL	€
PERFOM14013	1023	555	2000	1200	7035+7016	1044,60
PERFOM14014	1023	555	2000	1200	7035	1044,60
PERFOM14015	1023	555	2000	1200	5012	1044,60

Composto da:

qtà	descrizione
1	Armadio con porte a battente
1	Kit 2 piani fessurati con guide
1	Kit 3 piani fessurati con guide
1	Coppia pannelli forati per porta a battente
1	Kit 3 piani fessurati
10	Barra aggancio per contenitori Picking Box misura 1/2
40	Contenitore in polipropilene Picking Box misura 1
5	Contenitore in polipropilene Picking Box misura 2
6	Contenitore in polipropilene Picking Box misura 4
20	Contenitore in polipropilene Picking Box misura 3A2
6	Contenitore in polipropilene Picking Box misura 4A2



ART.	L mm	P mm	H mm	KG	RAL	€
PERFOM14016	1023	555	2000	1200	7035+7016	1165,50
PERFOM14017	1023	555	2000	1200	7035	1165,50
PERFOM14018	1023	555	2000	1200	5012	1160,10

Composto da:

qtà	descrizione
1	Armadio con porte a battente
3	Cassetto a estrazione semplice H=100 mm
2	Kit 2 piani fessurati con guide
1	Coppia pannelli forati per porta a battente
1	Piano fessurato
1	Piano/pannello forato
16	Barra aggancio per contenitori Picking Box misura 1/2
40	Contenitore in polipropilene Picking Box misura 1
23	Contenitore in polipropilene Picking Box misura 2
20	Contenitore in polipropilene Picking Box misura 3A2



RAL 5012



RAL 7035



RAL 7035 + RAL 7016



PORTATA

**Armadi a porte battente**



**Armadio a porte a battente 64x27 EH**

ART.	L mm	P mm	H mm	KG	RAL	€
FAA1520C000PD	1193	555	1000	800	7035+7016	414,30
FAA1520C00008	1193	555	1000	800	7035	414,30
FAA1520C00004	1193	555	1000	800	5012	414,30

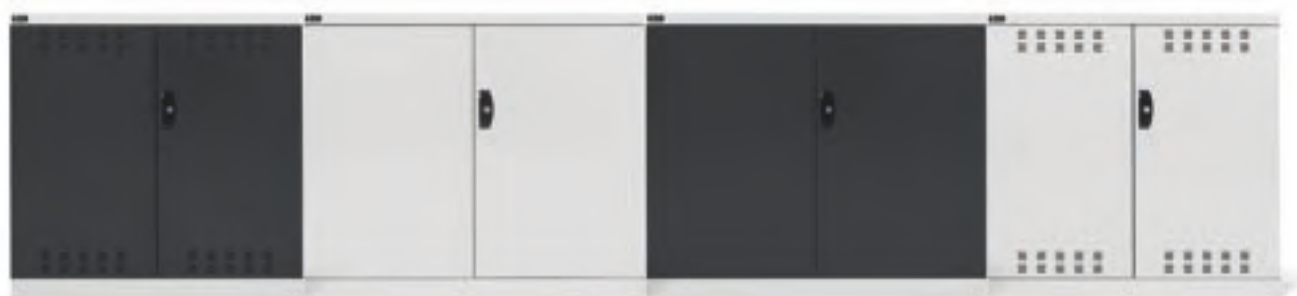

**Armadio a porte a battente 64x27 EH**

ART.	L mm	P mm	H mm	KG	RAL	€
FAA1720C000PD	1193	555	2000	1200	7035+7016	498,30
FAA1720C00008	1193	555	2000	1200	7035	498,30
FAA1720C00004	1193	555	2000	1200	5012	498,30

**Armadi a porte battente**



**Armadio a porte a battente 24x27 EH**

ART.	L mm	P mm	H mm	KG	RAL	€
FAA1120C000PD	512	555	1000	800	7035+7016	238,20
FAA1120C00008	512	555	1000	800	7035	238,20
FAA1120C00004	512	555	1000	800	5012	238,20



**Armadio a porte a battente fessurate 24x27 EH**

ART.	L mm	P mm	H mm	KG	RAL	€
FAA1130C00030	512	555	1000	800	1004	238,20
FAA1130C000PD	512	555	1000	800	7035+7016	238,20
FAA1130C00008	512	555	1000	800	7035	238,20
FAA1130C00004	512	555	1000	800	5012	238,20



**Armadio a porte a battente 54x27 EH**

ART.	L mm	P mm	H mm	KG	RAL	€
FAA1220C000PD	1023	555	1000	800	7035+7016	336,00
FAA1220C00008	1023	555	1000	800	7035	336,00
FAA1220C00004	1023	555	1000	800	5012	336,00



**Armadio a porte a battente fessurate 54x27 EH**

ART.	L mm	P mm	H mm	KG	RAL	€
FAA1230C00030	1023	555	1000	800	1004	336,00
FAA1230C0002Y	1023	555	1000	800	3020	336,00
FAA1230C000PD	1023	555	1000	800	7035+7016	336,00
FAA1230C00008	1023	555	1000	800	7035	336,00
FAA1230C00004	1023	555	1000	800	5012	336,00
FAA1230C00002	1023	555	1000	800	6011	336,00



RAL 6011



RAL 1004



RAL 3020



RAL 5012



RAL 7035



RAL 7035 + RAL 7016



PORTATA

**Armadi a porte battente**



**Armadio a porte a battente 54x27 EH**

ART.	L mm	P mm	H mm	KG	RAL	€
FAA1420C000PD	1023	555	2000	1200	7035+7016	414,30
FAA1420C00008	1023	555	2000	1200	7035	414,30
FAA1420C00004	1023	555	2000	1200	5012	414,30



**Armadio a porte a battente fessurate 54x27 EH**

ART.	L mm	P mm	H mm	KG	RAL	€
FAA1430C00030	1023	555	2000	1200	1004	414,30
FAA1430C000PD	1023	555	2000	1200	7035+7016	414,30
FAA1430C00008	1023	555	2000	1200	7035	414,30
FAA1430C00004	1023	555	2000	1200	5012	414,30
FAA1430C00002	1023	555	2000	1200	6011	414,30



**Armadi a porte battente**



**Armadio a porte a battente fessurate in policarbonato 54x27 EH**

ART.	L mm	P mm	H mm	KG	RAL	€
FAA1440C000PD	1023	555	2000	1200	7035+7016	540,00
FAA1440C00008	1023	555	2000	1200	7035	540,00
FAA1440C00004	1023	555	2000	1200	5012	540,00



**Armadio a porte a battente fessurate safe crash 54x27 EH**

ART.	L mm	P mm	H mm	KG	RAL	€
FAA1440C05C2Y	1023	555	2000	1200	3020	618,00



-   
RAL 6011
-   
RAL 1004
-   
RAL 3020
-   
RAL 5012
-   
RAL 7035
-   
RAL 7035 + RAL 7016
-   
PORTATA

**Armadi a porte battente**



**Top a 3 bordi rivestiti in PVC**

ART.	L mm	P mm	H mm	colore	€
FAC9911290007	514	558	31	Nero	52,80
FAC9912290007	1024	558	31	Nero	69,90
FAC9915290007	1194	558	31	Nero	71,10



**Top in acciaio gommato**

ART.	L mm	P mm	H mm	colore	€
FAC9911360007	512	555	32	Nero	126,00
FAC9912360007	1023	555	32	Nero	192,00
FAC9915360007	1193	555	32	Nero	201,00

**Piano fessurato P=500 mm**

ART.	L mm	P mm	H mm		finitura	€
FAC9911010099	484	500	35	120	Zincato	17,10
FAC9912010099	995	500	35	120	Zincato	23,70
FAC9915010099	1165	500	35	120	Zincato	29,40



**Kit piani fessurati P=500 mm**

ART.	L mm	P mm	H mm	n. piani		finitura	€
FAC9911020099	484	500	35	2	120	Zincato	26,40
FAC9911030099	484	500	35	3	120	Zincato	38,70
FAC9912020099	995	500	35	2	120	Zincato	46,50
FAC9912030099	995	500	35	3	120	Zincato	68,70
FAC9912040099	995	500	35	4	120	Zincato	91,20
FAC9915020099	1165	500	35	2	120	Zincato	57,30
FAC9915030099	1165	500	35	3	120	Zincato	86,70



**Kit piani fessurati P=345 mm**

ART.	L mm	P mm	H mm	n. piani		finitura	€
FAC9912050099	995	345	35	2	100	Zincato	46,50
FAC9912060099	995	345	35	3	100	Zincato	68,70





**Armadi a porte battente**

**Piano/pannello forato**

Applicabile in 3 diverse posizioni:

Pannello forato verticale

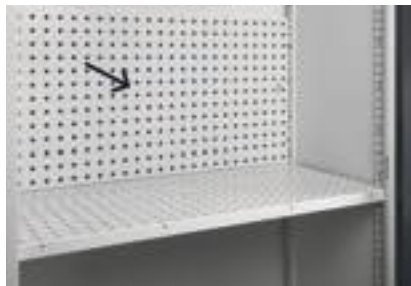

Piano orizzontale



Mensola forata a 4 bordi



**Piano/pannello forato**

ART.	L mm	P mm	H mm	KG	Dim. foro mm	Passo mm	RAL	€
FAC9912070039	995	500	30	120-50	10x10	38	7016	59,40
FAC9912070008	995	500	30	120-50	10x10	38	7035	59,40
FAC9912070004	995	500	30	120-50	10x10	38	5012	54,00

**Kit piani-pannelli forati**

ART.	L mm	P mm	H mm	n. piani	KG	Dim. foro mm	Passo mm	RAL	€
FAC9912080008	995	500	30	2	120-50	10x10	38	7035	114,60
FAC9912080004	995	500	30	2	120-50	10x10	38	5012	102,00
FAC9912080039	995	500	30	2	120-50	10x10	38	7016	114,60



**Barre aggancio contenitori con 4 contenitori Picking Box mis. 1**

ART.	L mm	P mm	H mm	colore contenitori	€
FBLIT011000	445	168	85	Grigio scuro	9,60
FBLIT029000	445	168	85	Blu	9,60



**Coppia pannelli forati per porta a battente**

Si può applicare fino ad un massimo di una coppia pannelli per porta

ART.	L mm	P mm	H mm	Dim. foro mm	Passo mm	RAL	€
FAC9912250039	381	20	824	10x10	38	7016	59,40



ZINCATO



RAL 5012



RAL 7035



RAL 7016



PORTATA



**Cassetti ad estrazione semplice 24x27 EH**

ART.	dim. utili			KG	%	h frontale cassetto	RAL	€
	L mm	P mm	H mm					
FAC9911180008	398	449	85	50	88%	100	7035	60,00
FAC9911180004	398	449	85	50	88%	100	5012	60,00
FAC9911180039	398	449	85	50	88%	100	7016	70,20



**Cassetti ad estrazione semplice 54x27 EH**

ART.	dim. utili			KG	%	h frontale cassetto	RAL	€
	L mm	P mm	H mm					
FAC9912180008	908	449	85	50	88%	100	7035	71,10
FAC9912180004	908	449	85	50	88%	100	5012	71,10
FAC9912180039	908	449	85	50	88%	100	7016	88,20



**Cassetti ad estrazione telescopica 54x27 EH**

ART.	dim. utili			KG	%	h frontale cassetto	RAL	€
	L mm	P mm	H mm					
FAC9912190008	908	449	85	100	100%	100	7035	96,00
FAC9912190004	908	449	85	100	100%	100	5012	96,00
FAC9912190039	908	449	85	100	100%	100	7016	112,80
FAC9912210008	908	449	135	100	100%	150	7035	108,90
FAC9912210004	908	449	135	100	100%	150	5012	108,90
FAC9912210039	908	449	135	100	100%	150	7016	120,90



**Cassetti ad estrazione telescopica 64x27 EH**

ART.	dim. utili			KG	%	h frontale cassetto	RAL	€
	L mm	P mm	H mm					
FAC9915190008	1078	449	85	100	100%	100	7035	123,60
FAC9915190004	1078	449	85	100	100%	100	5012	123,60
FAC9915190039	1078	449	85	100	100%	100	7016	138,60

**Armadi a porte battente**



**Zoccolo per transpallet completo di chiusura**

ART.	L mm	P mm	H mm	KG	RAL	€
FAC9912170039	1018	550	100	1200	7016	142,20
FAC9915170039	1188	550	100	1200	7016	163,80



**Vasca stagna esterna di raccolta liquidi capacità 59 L**

ART.	L mm	P mm	H mm	KG	L	RAL	€
FAC9912130039	1048	600	167	1200	59	7016	99,00



vedi pag. 256

**Vasche stagne interne raccolta liquidi**

ART.	L mm	P mm	H mm	KG	L	finitura	€
FAC9911090099	484	500	42	50	9	Zincato	46,50
FAC9912090099	995	500	42	50	19	Zincato	51,00



**Kit vasche stagne interne raccolta liquidi**

ART.	L mm	P mm	H mm	KG	L	n. vasche	finitura	€
FAC9911100099	484	500	42	50	9	2	Zincato	92,70
FAC9912100099	995	500	42	50	19	2	Zincato	102,00



**Kit piano fessurato con 2 separatori e 6 taniche con rubinetto a sfera**

ART.	L mm	P mm	H mm	n. taniche	L taniche	finitura piano	€
FAC9912280099	995	495	315	6	10	Zincato	423,90



**Armadi a porte battente**



**Canaletta elettrica per multiprese**

ART.	L mm	P mm	H mm	RAL	€
FAC9912220039	1008	64	140	7016	33,00



**schema multiprese per canaletta elettrica**



- 1
- 2
- 3
- 3
- 4

- 1 magnetotermico
- 2 multipresa 4 scomparti
- 3 multipresa 2 scomparti
- 4 USB ricarica



Applicazione canaletta elettrica sulla **parte superiore** del **piano-pannello forato**



Applicazione canaletta elettrica sulla **parte inferiore** del **piano-pannello forato**



Canaletta elettrica **integrabile** con **piano-pannello forato** in posizione verticale



**Supporto laterale per multipresa**

ART.	L mm	P mm	H mm	RAL	€
FAC9912240039	10	463	77	7016	18,60

**schema multiprese per supporto laterale**



multipresa 4 scomparti



Esempio di applicazione con:  
 1 supporto art. FAC9912240039  
 1 multipresa art. FBLET005007  
 1 cavo di collegamento art. FBLET016007

**Armadi a porte battente**



**Griglia per ventole**

ART.	L mm	P mm	H mm	RAL	€
FAC9912230039	994	123	136	7016	39,00

Esempio di applicazione con:  
 1 griglia art. FAC9912230039  
 2 ventole art. FAS32200100  
 1 multipresa art. FBLET005007  
 1 cavo di collegamento art. FBLET016007



Applicazione griglia nella **parte superiore** dell'armadio **senza** l'ausilio del **piano-pannello forato**



Applicazione griglia nella **parte superiore** dell'armadio **con** l'ausilio del **piano-pannello forato**



Applicazione griglia nella **parte inferiore** dell'armadio **con** l'ausilio del **piano-pannello forato**



**Ventola 230 V senza griglia con spina Schuko**

ART.	L mm	P mm	H mm	colore	€
FAS32200100	125	44	125	Nero	30,00



vedi pag. 96



FBLET012007



FBLET004007



FBLET005007



FBLET016007



FBLET014007



FBLET020007



FBL99400008

**Applicazione della lampada sotto il piano-pannello forato**



**Armadi a porte battente**



1. Leggio
2. Cassetto a estrazione semplice H=100 mm
3. Coppia piastre portaruote
4. Kit ruote in gomma standard Ø 100 mm



**Leggio**

ART.	L mm	P mm	H mm	RAL	€
FAC9911340004	516	564	316	5012	119,40
FAC9911340008	516	564	316	7035	119,40
FAC9911340039	516	564	316	7016	119,40



**Cassetti ad estrazione semplice 24x27 EH**

ART.	dim. utili			KG	🔒	h frontale cassetto	RAL	€
	L mm	P mm	H mm					
FAC9911180008	398	449	85	50	88%	100	7035	60,00
FAC9911180004	398	449	85	50	88%	100	5012	60,00
FAC9911180039	398	449	85	50	88%	100	7016	70,20



**Parete di chiusura anteriore per leggio**

ART.	L mm	P mm	H mm	RAL	€
FAC9911350004	454	60	101	5012	15,90
FAC9911350008	454	60	101	7035	15,90
FAC9911350039	454	60	101	7016	15,90



**Coppia piastre portaruote**

ART.	L mm	P mm	H mm	€
FAC9911330099	114	550	13	28,50



**Kit ruote**

ART.	Ø mm	KG	KG	H mm	materiale	🔒	🔒	€
FKRD1002107	100	75	225	128	Gomma standard	2	2	44,10
FKRB1252107	125	100	300	155	Gomma standard	2	2	48,90
FKRU1252101	125	100	300	155	Gomma antitraccia sintetica	2	2	53,40
FKRS1252101	125	250	750	155	Gomma elastica	2	2	85,20



RUOTA GIREVOLE CON FRENO



RUOTA FISSA



## Armadi a porte battente

1. Parete divisorio
2. Kit tubo appendiabiti
3. Piano/pannello forato
4. Piano fessurato
5. Cassetto a estrazione semplice H=100 mm

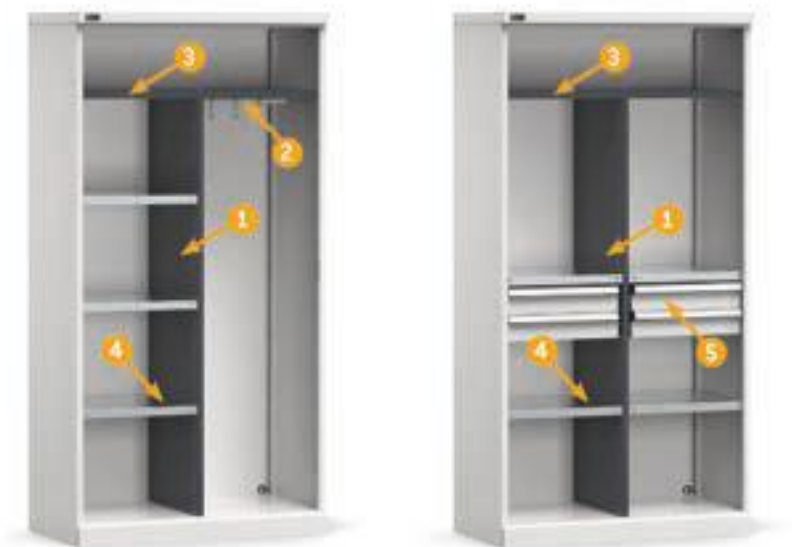

### Parete divisorio

ART.	L mm	P mm	H mm	Passo mm	RAL	€
FAC9912260039	44	500	1616	25	7016	79,20

### Kit tubo appendiabiti

ART.	L mm	P mm	H mm	KG	finitura	€
FAC9912270099	458	23	56	15	Zincato	10,80

### Piano/pannello forato

ART.	L mm	P mm	H mm	KG	RAL	€
FAC9912070039	995	500	30	120-50	7016	59,40

### Piano fessurato P=500 mm

ART.	L mm	P mm	H mm	KG	finitura	€
FAC9911010099	484	500	35	120	Zincato	17,10

### Kit piani fessurati P=500 mm

ART.	L mm	P mm	H mm	n. piani	KG	finitura	€
FAC9911020099	484	500	35	2	120	Zincato	26,40
FAC9911030099	484	500	35	3	120	Zincato	38,70

### Cassetti ad estrazione semplice 24x27 EH

ART.	dim. utili			KG	%	h frontale cassetto	RAL	€
	L mm	P mm	H mm					
FAC9911180008	398	449	85	50	88%	100	7035	60,00
FAC9911180004	398	449	85	50	88%	100	5012	60,00
FAC9911180039	398	449	85	50	88%	100	7016	70,20



**PERFOM****MATERIALE DI SEPARAZIONE****L= 512 MM****24X27 EH**

ART.	adatto per cassetto H mm	componenti	€
FFH00500100	100	2 x Divisorio trasversale L=202 mm 1 x Divisorio longitudinale fessurato L=457 mm	7,20



ART.	adatto per cassetto H mm	componenti	€
FFH00500800	100/125	3 x Cassetta divisorio 150x75 mm 6 x Cassetta divisorio 150x150 mm	20,10



ART.	adatto per cassetto H mm	componenti	€
FFH00500900	100/125	15 x Cassetta divisorio 150x75 mm	24,60

**L= 1023 MM****54X27 EH**

ART.	adatto per cassetto H mm	componenti	€
FFH02000100	100	4 x Divisorio longitudinale fessurato L=457 mm 4 x Divisorio trasversale L=151 mm	22,50



ART.	adatto per cassetto H mm	componenti	€
FFH02000200	100	5 x Divisorio longitudinale fessurato L=457 mm 10 x Divisorio trasversale L=151 mm	34,50



ART.	adatto per cassetto H mm	componenti	€
FFH02000600	100/125	12 x Cassetta divisorio 150x75 mm 12 x Cassetta divisorio 150x150 mm	48,00

**L= 1193 MM**

**64X27 EH**



ART.	adatto per cassetto H mm	componenti	€
FFH02500300	100	3 x Divisorio longitudinale fessurato L=457 mm 1 x Divisorio longitudinale fessurato L=610 mm 3 x Divisorio trasversale L=151 mm 2 x Divisorio trasversale L=168 mm 2 x Divisorio trasversale L=304 mm	28,80



ART.	adatto per cassetto H mm	componenti	€
FFH02500400	100	3 x Divisorio longitudinale fessurato L=457 mm 1 x Divisorio trasversale L=168 mm 3 x Divisorio trasversale L=304 mm	20,40



ART.	adatto per cassetto H mm	componenti	€
FFH02500600	100	10 x Cassetta divisorio 150x75 mm 10 x Cassetta divisorio 150x150 mm 2 x Divisorio longitudinale fessurato L=457 mm 2 x Divisorio trasversale L=134 mm 2 x Divisorio trasversale L=202 mm	48,60

# PERFOM

## ARMADI CON PORTE SCORREVOLI



Portata 800/1200 kg



Garanzia porte

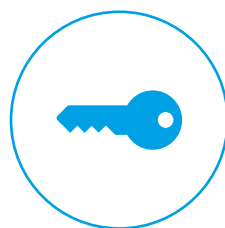

Chiusura a chiave

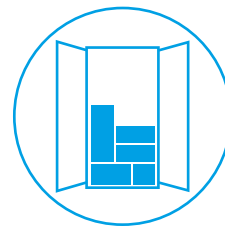

Armadio montato +  
accessori confezionati  
all'interno

**PERFOM**





ART.	L mm	P mm	H mm		RAL	€
<b>PERFOM21001</b>	1020	600	2000	1200	7035+7016	831,00
<b>PERFOM21002</b>	1020	600	2000	1200	7035	831,00
<b>PERFOM21003</b>	1020	600	2000	1200	5012	831,00

Composto da:

qtà	descrizione
1	Armadio con porte scorrevoli
1	Kit 4 piani fessurati



ART.	L mm	P mm	H mm		RAL	€
<b>PERFOM23001</b>	1020	600	2000	1200	7035+7016	943,80

Composto da:

qtà	descrizione
1	Armadio con porte scorrevoli fessurate
2	Kit 2 vasche stagne interne di raccolta liquidi capacità 19 L



vedi pag. 256



ART.	L mm	P mm	H mm		RAL	€
<b>PERFOM25001</b>	1020	600	2000	1200	7035+7016	1018,50

Composto da:

qtà	descrizione
1	Armadio con porte scorrevoli fessurate in policarbonato
1	Kit 4 piani fessurati





ART.	L mm	P mm	H mm		RAL	€
<b>PERFOM20001</b>	1020	600	915	800	7035+7016	589,50
<b>PERFOM20002</b>	1020	600	915	800	7035	589,50
<b>PERFOM20003</b>	1020	600	915	800	5012	589,50

Composto da:

qtà	descrizione
1	Armadio con porte scorrevoli
1	Piano fessurato



ART.	L mm	P mm	H mm		RAL	€
<b>PERFOM22001</b>	1020	600	915	800	7035+7016	667,80

Composto da:

qtà	descrizione
1	Armadio con porte scorrevoli fessurate
1	Kit 2 vasche stagne interne di raccolta liquidi capacità 19 L



vedi pag. 256



ART.	L mm	P mm	H mm		RAL	€
<b>PERFOM24001</b>	1020	600	915	800	7035+7016	722,40

Composto da:

qtà	descrizione
1	Armadio con porte scorrevoli fessurate in policarbonato
1	Piano fessurato



RAL 5012



RAL 7035



RAL 7035 + RAL 7016



PORTATA



ART.	L mm	P mm	H mm		RAL	€
<b>PERFOM21004</b>	1428	600	2000	1200	7035+7016	1080,90
<b>PERFOM21005</b>	1428	600	2000	1200	7035	1080,90
<b>PERFOM21006</b>	1428	600	2000	1200	5012	1080,90

Composto da:

qtà	descrizione
1	Armadio con porte scorrevoli
2	Kit 2 piani fessurati



ART.	L mm	P mm	H mm		RAL	€
<b>PERFOM25002</b>	1428	600	2000	1200	7035+7016	1385,10

Composto da:

qtà	descrizione
1	Armadio con porte scorrevoli fessurate in policarbonato
2	Kit 2 piani fessurati





ART.	L mm	P mm	H mm	KG	RAL	€
PERFOM20004	1428	600	915	800	7035+7016	742,50
PERFOM20005	1428	600	915	800	7035	742,50
PERFOM20006	1428	600	915	800	5012	742,50

Composto da:

qtà	descrizione
1	Armadio con porte scorrevoli
1	Piano fessurato



ART.	L mm	P mm	H mm	KG	RAL	€
PERFOM24002	1428	600	915	800	7035+7016	870,00

Composto da:

qtà	descrizione
1	Armadio con porte scorrevoli fessurate in policarbonato
1	Piano fessurato



RAL 5012



RAL 7035



RAL 7035 + RAL 7016



PORTATA



ART.	L mm	P mm	H mm	KG per vano	RAL	€
<b>PERFOM21010</b>	2040	600	2000	1200	7035+7016	1834,20
<b>PERFOM21011</b>	2040	600	2000	1200	7035	1834,20
<b>PERFOM21012</b>	2040	600	2000	1200	5012	1834,20

Composto da:

qtà	descrizione
1	Armadio con porte scorrevoli
6	Cassetto a estrazione semplice H=100 mm
2	Kit 4 piani fessurati

ART.	L mm	P mm	H mm	KG per vano	RAL	€
<b>PERFOM23004</b>	2040	600	2000	1200	7035+7016	2060,10

Composto da:

qtà	descrizione
1	Armadio con porte scorrevoli fessurate
3	Kit 2 piani/pannelli forati
1	Piano fessurato
1	Piano interno in multiplex
1	Cassetto a estrazione semplice H=100 mm
2	Canaletta elettrica per multiprese
1	Supporto laterale per multiprese
3	Multipresa schuko a 4 scomparti
4	Multipresa schuko a 2 scomparti
2	Cavo di collegamento wieland schuko/francese
1	Cavo di collegamento wieland con spine in/out
1	Coppia squadrette a L
1	Snodo per piastra
1	Piastra porta monitor con standard VESA
1	Mensola porta oggetti reversibile



ART.	L mm	P mm	H mm	KG per vano	RAL	€
<b>PERFOM25004</b>	2040	600	2000	1200	7035+7016	2037,30

Composto da:

qtà	descrizione
1	Armadio con porte scorrevoli fessurate in policarbonato
4	Kit 2 vasche stagne interne di raccolta liquidi capacità 19 L



vedi pag. 256



ART.	L mm	P mm	H mm	 per vano	RAL	€
<b>PERFOM21007</b>	2040	600	2000	1200	7035+7016	1407,60
<b>PERFOM21008</b>	2040	600	2000	1200	7035	1407,60
<b>PERFOM21009</b>	2040	600	2000	1200	5012	1407,60

Composto da:

qtà	descrizione
1	Armadio con porte scorrevoli
2	Kit 4 piani fessurati



ART.	L mm	P mm	H mm	 per vano	RAL	€
<b>PERFOM23003</b>	2040	600	2000	1200	7035+7016	1633,20

Composto da:

qtà	descrizione
1	Armadio con porte scorrevoli fessurate
4	Kit 2 vasche stagne interne di raccolta liquidi capacità 19 L



vedi pag. 256



ART.	L mm	P mm	H mm	 per vano	RAL	€
<b>PERFOM25003</b>	2040	600	2000	1200	7035+7016	1811,70

Composto da:

qtà	descrizione
1	Armadio con porte scorrevoli fessurate in policarbonato
2	Kit 4 piani fessurati



RAL 5012



RAL 7035



RAL 7035 + RAL 7016



PORTATA



ART.	L mm	P mm	H mm	 per vano	RAL	€
<b>PERFOM20007</b>	2040	600	915	800	7035+7016	969,90
<b>PERFOM20008</b>	2040	600	915	800	7035	969,90
<b>PERFOM20009</b>	2040	600	915	800	5012	969,90

Composto da:

qtà	descrizione
1	Armadio con porte scorrevoli
2	Piano fessurato



ART.	L mm	P mm	H mm	 per vano	RAL	€
<b>PERFOM22002</b>	2040	600	915	800	7035+7016	1126,50

Composto da:

qtà	descrizione
1	Armadio con porte scorrevoli fessurate
2	Kit 2 vasche stagne interne di raccolta liquidi capacità 19 L



vedi pag. 256



ART.	L mm	P mm	H mm	 per vano	RAL	€
<b>PERFOM24003</b>	2040	600	915	800	7035+7016	1146,90

Composto da:

qtà	descrizione
1	Armadio con porte scorrevoli fessurate in policarbonato
2	Piano fessurato



**Armadi con porte scorrevoli**



**Armadio con porte scorrevoli 54x27 EH**

ART.	L mm	P mm	H mm		RAL	€
FAA2010C000PD	1020	600	915	800	7035+7016	565,80
FAA2010C00008	1020	600	915	800	7035	565,80
FAA2010C00004	1020	600	915	800	5012	565,80



**Armadio con porte scorrevoli 78x27 EH**

ART.	L mm	P mm	H mm		RAL	€
FAA2014C000PD	1428	600	915	800	7035+7016	701,40
FAA2014C00008	1428	600	915	800	7035	701,40
FAA2014C00004	1428	600	915	800	5012	701,40



**Armadio con porte scorrevoli 54+54x27 EH**

ART.	L mm	P mm	H mm	 per vano	RAL	€
FAA2020C000PD	2040	600	915	800	7035+7016	922,50
FAA2020C00008	2040	600	915	800	7035	922,50
FAA2020C00004	2040	600	915	800	5012	922,50



**Armadio con porte scorrevoli 54x27 EH**

ART.	L mm	P mm	H mm		RAL	€
FAA2110C000PD	1020	600	2000	1200	7035+7016	739,80
FAA2110C00008	1020	600	2000	1200	7035	739,80
FAA2110C00004	1020	600	2000	1200	5012	739,80



**Armadio con porte scorrevoli 78x27 EH**

ART.	L mm	P mm	H mm		RAL	€
FAA2114C000PD	1428	600	2000	1200	7035+7016	926,10
FAA2114C00008	1428	600	2000	1200	7035	926,10
FAA2114C00004	1428	600	2000	1200	5012	926,10



**Armadio con porte scorrevoli 54+54x27 EH**

ART.	L mm	P mm	H mm	 per vano	RAL	€
FAA2120C000PD	2040	600	2000	1200	7035+7016	1225,20
FAA2120C00008	2040	600	2000	1200	7035	1225,20
FAA2120C00004	2040	600	2000	1200	5012	1225,20

**Armadi con porte scorrevoli**



**Armadio con porte scorrevoli fessurate 54x27 EH**

ART.	L mm	P mm	H mm	 KG	RAL	€
FAA2210C000PD	1020	600	915	800	7035+7016	565,80



**Armadio con porte scorrevoli fessurate 78x27 EH**

ART.	L mm	P mm	H mm	 KG	RAL	€
FAA2214C000PD	1428	600	915	800	7035+7016	701,40



**Armadio con porte scorrevoli fessurate 54+54x27 EH**

ART.	L mm	P mm	H mm	 KG per vano	RAL	€
FAA2220C000PD	2040	600	915	800	7035+7016	922,50



**Armadio con porte scorrevoli fessurate 54x27 EH**

ART.	L mm	P mm	H mm	 KG	RAL	€
FAA2310C000PD	1020	600	2000	1200	7035+7016	739,80



**Armadio con porte scorrevoli fessurate 78x27 EH**

ART.	L mm	P mm	H mm	 KG	RAL	€
FAA2314C000PD	1428	600	2000	1200	7035+7016	926,10



**Armadio con porte scorrevoli fessurate 54+54x27 EH**

ART.	L mm	P mm	H mm	 KG per vano	RAL	€
FAA2320C000PD	2040	600	2000	1200	7035+7016	1225,20

**Armadi con porte scorrevoli**



**Armadio con porte scorrevoli fessurate in policarbonato 54x27 EH**

ART.	L mm	P mm	H mm		RAL	€
FAA2410C000PD	1020	600	915	800	7035+7016	698,70



**Armadio con porte scorrevoli fessurate in policarbonato 78x27 EH**

ART.	L mm	P mm	H mm		RAL	€
FAA2414C000PD	1428	600	915	800	7035+7016	828,90



**Armadio con porte scorrevoli fessurate in policarbonato 54+54x27 EH**

ART.	L mm	P mm	H mm	 per vano	RAL	€
FAA2420C000PD	2040	600	915	800	7035+7016	1099,50



**Armadio con porte scorrevoli fessurate in policarbonato 54x27 EH**

ART.	L mm	P mm	H mm		RAL	€
FAA2510C000PD	1020	600	2000	1200	7035+7016	927,30



**Armadio con porte scorrevoli fessurate in policarbonato 54x27 EH**

ART.	L mm	P mm	H mm		RAL	€
FAA2514C000PD	1428	600	2000	1200	7035+7016	1230,30



**Armadio con porte scorrevoli fessurate in policarbonato 54+54x27 EH**

ART.	L mm	P mm	H mm	 per vano	RAL	€
FAA2520C000PD	2040	600	2000	1200	7035+7016	1629,30



RAL 7035 + RAL 7016



PORTATA

**Armadi con porte scorrevoli**



**Top in acciaio inox satinato**

ART.	L mm	P mm	H mm	materiale	finitura	€
FGG601006AX000A	1020	600	32	MDF	Inox satinato	221,10
FGG601406AX000A	1428	600	32	MDF	Inox satinato	281,70
FGG602006AX000A	2040	600	32	MDF	Inox satinato	374,10



**Top in acciaio gommato**

ART.	L mm	P mm	H mm	materiale	finitura	€
FGG601006AG0007	1020	600	32	MDF	Acciaio gommato	205,50
FGG601406AG0007	1428	600	32	MDF	Acciaio gommato	249,30
FGG602006AG0007	2040	600	32	MDF	Acciaio gommato	341,70



**Top in multiplex**

ART.	L mm	P mm	H mm	materiale	€
FGG601006BE0000	1020	600	30	Multiplex	115,80
FGG601406BE0000	1428	600	30	Multiplex	105,00
FGG602006BE0000	2040	600	30	Multiplex	139,20



**Piano fessurato P=500 mm**

ART.	L mm	P mm	H mm		finitura	€
FAC9912010099	995	500	35	120	Zincato	23,70
FAC9814010099	1403	500	35	100	Zincato	41,10

**Kit piani fessurati P=500 mm**

ART.	L mm	P mm	H mm	n. piani		finitura	€
FAC9912020099	995	500	35	2	120	Zincato	46,50
FAC9912030099	995	500	35	3	120	Zincato	68,70
FAC9912040099	995	500	35	4	120	Zincato	91,20
FAC9814020099	1403	500	35	2	100	Zincato	77,40

**Armadi con porte scorrevoli**

**Piano/pannello forato**

Applicabile in 3 diverse posizioni:

Pannello forato verticale

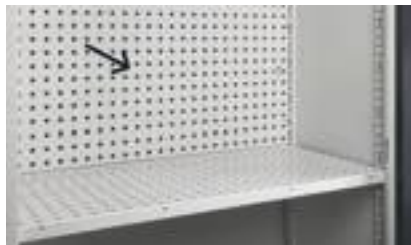

Piano orizzontale



Mensola forata a 4 bordi



**Piano/pannello forato**



ART.	L mm	P mm	H mm	 KG	Dim. foro mm	Passo mm	RAL	€
FAC9912070039	995	500	30	120-50	10x10	38	7016	59,40
FAC9912070008	995	500	30	120-50	10x10	38	7035	59,40
FAC9912070004	995	500	30	120-50	10x10	38	5012	54,00

**Kit piani-pannelli forati**

ART.	L mm	P mm	H mm	n. piani	 KG	Dim. foro mm	Passo mm	RAL	€
FAC9912080008	995	500	30	2	120-50	10x10	38	7035	114,60
FAC9912080004	995	500	30	2	120-50	10x10	38	5012	102,00
FAC9912080039	995	500	30	2	120-50	10x10	38	7016	114,60



**Cassetti ad estrazione semplice 54x27 EH**



ART.	dim. utili			 KG		h frontale cassetto	RAL	€
	L mm	P mm	H mm					
FAC9912180008	908	449	85	50	88%	100	7035	71,10
FAC9912180004	908	449	85	50	88%	100	5012	71,10
FAC9912180039	908	449	85	50	88%	100	7016	88,20

**Cassetti ad estrazione telescopica 54x27 EH**



ART.	dim. utili			 KG		h frontale cassetto	RAL	€
	L mm	P mm	H mm					
FAC9912190008	908	449	85	100	100%	100	7035	96,00
FAC9912190004	908	449	85	100	100%	100	5012	96,00
FAC9912190039	908	449	85	100	100%	100	7016	112,80
FAC9912210008	908	449	135	100	100%	150	7035	108,90
FAC9912210004	908	449	135	100	100%	150	5012	108,90
FAC9912210039	908	449	135	100	100%	150	7016	120,90



ZINCATO



RAL 5012



RAL 7035



RAL 7016



PORTATA



ESTRAZIONE

**Armadi con porte scorrevoli**

**Vasche stagne interne raccolta liquidi**



ART.	L mm	P mm	H mm	KG	L	finitura	€
FAC9911090099	484	500	42	50	9	Zincato	46,50
FAC9912090099	995	500	42	50	19	Zincato	51,00

**Kit vasche stagne interne raccolta liquidi**

ART.	L mm	P mm	H mm	KG	L	n. vasche	finitura	€
FAC9911100099	484	500	42	50	9	2	Zincato	92,70
FAC9912100099	995	500	42	50	19	2	Zincato	102,00

**Canaletta elettrica per multiprese**



ART.	L mm	P mm	H mm	RAL	€
FAC9912220039	1008	64	140	7016	33,00



**schema multiprese per canaletta elettrica**



- 1
- 2
- 3
- 3
- 4

- 1 magnetotermico
- 2 multipresa 4 scomparti
- 3 multipresa 2 scomparti
- 4 USB ricarica



Applicazione canaletta elettrica sulla **parte superiore** del **piano-pannello forato**



Applicazione canaletta elettrica sulla **parte inferiore** del **piano-pannello forato**



Canaletta elettrica **integrabile** con **piano-pannello forato** in posizione verticale

**Supporto laterale per multipresa**



ART.	L mm	P mm	H mm	RAL	€
FAC9912240039	10	463	77	7016	18,60

**schema multiprese per supporto laterale**



multipresa 4 scomparti



Esempio di applicazione con:  
 1 supporto art. FAC9912240039  
 1 multipresa art. FBLET005007  
 1 cavo di collegamento art. FBLET016007



**Armadi con porte scorrevoli**



**Griglia per ventole**

ART.	L mm	P mm	H mm	RAL	€
FAC9912230039	994	123	136	7016	39,00

Esempio di applicazione con:  
 1 griglia art. FAC9912230039  
 2 ventole art. FAS32200100  
 1 multipresa art. FBLET005007  
 1 cavo di collegamento art. FBLET016007



Applicazione griglia nella **parte superiore** dell'armadio **senza** l'ausilio del **piano-pannello forato**



Applicazione griglia nella **parte superiore** dell'armadio **con** l'ausilio del **piano-pannello forato**



Applicazione griglia nella **parte inferiore** dell'armadio **con** l'ausilio del **piano-pannello forato**



**Ventola 230 V senza griglia con spina Schuko**

ART.	L mm	P mm	H mm	colore	€
FAS32200100	125	44	125	Nero	30,00



vedi pag. 96



FBLET012007



FBLET004007



FBLET005007



FBLET016007



FBLET014007



FBLET020007



FBL99400008

**Applicazione della lampada sotto il piano-pannello forato**



ZINCATO



RAL 7016



PORTATA



CAPACITÀ

**Armadi con porte scorrevoli**

- 1. Parete divisorio
- 2. Kit tubo appendiabiti
- 3. Piano/pannello forato
- 4. Piano fessurato
- 5. Cassetto a estrazione semplice H=100 mm

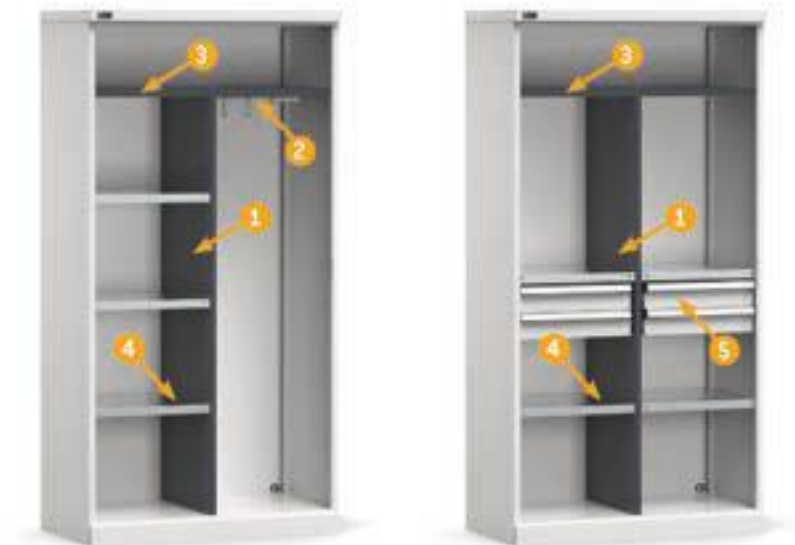

**Parete divisorio**

ART.	L mm	P mm	H mm	Passo mm	RAL	€
FAC9912260039	44	500	1616	25	7016	79,20

**Kit tubo appendiabiti**

ART.	L mm	P mm	H mm	KG	finitura	€
FAC9912270099	458	23	56	15	Zincato	10,80

**Piano/pannello forato**

ART.	L mm	P mm	H mm	KG	RAL	€
FAC9912070039	995	500	30	120-50	7016	59,40

**Piano fessurato P=500 mm**

ART.	L mm	P mm	H mm	KG	finitura	€
FAC9911010099	484	500	35	120	Zincato	17,10

**Kit piani fessurati P=500 mm**

ART.	L mm	P mm	H mm	n. piani	KG	finitura	€
FAC9911020099	484	500	35	2	120	Zincato	26,40
FAC9911030099	484	500	35	3	120	Zincato	38,70

**Cassetti ad estrazione semplice 24x27 EH**

ART.	dim. utili			KG	%	h frontale cassetto	RAL	€
	L mm	P mm	H mm					
FAC9911180008	398	449	85	50	88%	100	7035	60,00
FAC9911180004	398	449	85	50	88%	100	5012	60,00
FAC9911180039	398	449	85	50	88%	100	7016	70,20



**PERFOM****MATERIALE DI SEPARAZIONE****L= 512 MM****24X27 EH**

ART.	adatto per cassetto H mm	componenti	€
FFH00500100	100	2 x Divisorio trasversale L=202 mm 1 x Divisorio longitudinale fessurato L=457 mm	7,20



ART.	adatto per cassetto H mm	componenti	€
FFH00500800	100/125	3 x Cassetta divisorio 150x75 mm 6 x Cassetta divisorio 150x150 mm	20,10



ART.	adatto per cassetto H mm	componenti	€
FFH00500900	100/125	15 x Cassetta divisorio 150x75 mm	24,60

**L= 1023 MM****54X27 EH**

ART.	adatto per cassetto H mm	componenti	€
FFH02000100	100	4 x Divisorio longitudinale fessurato L=457 mm 4 x Divisorio trasversale L=151 mm	22,50

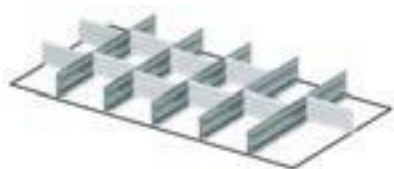

ART.	adatto per cassetto H mm	componenti	€
FFH02000200	100	5 x Divisorio longitudinale fessurato L=457 mm 10 x Divisorio trasversale L=151 mm	34,50



ART.	adatto per cassetto H mm	componenti	€
FFH02000600	100/125	12 x Cassetta divisorio 150x75 mm 12 x Cassetta divisorio 150x150 mm	48,00



ZINCATO



RAL 5012



RAL 7035



RAL 7016



PORTATA



ESTRAZIONE

# PERFOM

## ARMADI SPOGLIATOIO



**Piedini in polipropilene  
facile pulizia**

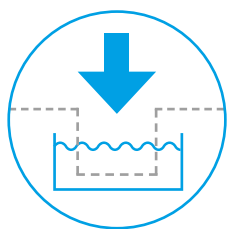

**Verniciatura in  
elettroforesi**



**Versione con vano porta  
casco**



**Chiusura a chiave**

# PERFOM



ART.	L mm	P mm	H mm	n. scomparti	RAL	€
<b>PERFOMAN01</b>	1195	502	1950	4	7035	464,40

Composto da:

qtà	descrizione
1	Armadio spogliatoio a tetto orizzontale a 4 scomparti
1	Coppia piedini per armadio spogliatoio



ART.	L mm	P mm	H mm	n. scomparti	RAL	€
<b>PERFOMAN02</b>	1195	502	1950	3	7035	464,40

Composto da:

qtà	descrizione
1	Armadio spogliatoio a tetto orizzontale a 3 scomparti
1	Coppia piedini per armadio spogliatoio



ART.	L mm	P mm	H mm	n. scomparti	RAL	€
<b>PERFOMAN03</b>	1195	502	2170	4	7035	534,00

Composto da:

qtà	descrizione
1	Armadio spogliatoio a tetto orizzontale a 4 scomparti
1	Tetto inclinato aggiuntivo
1	Coppia piedini per armadio spogliatoio

# PERFOM



ART.	L mm	P mm	H mm	n. scomparti	RAL	€
PERFOMAN04	1195	502	2170	3	7035	534,00

Composto da:

qtà	descrizione
1	Armadio spogliatoio a tetto orizzontale a 3 scomparti
1	Tetto inclinato aggiuntivo
1	Coppia piedini per armadio spogliatoio

## Panchina singola



ART.	L mm	P mm	H mm	KG	RAL	€
FAN95400001	1000	360	385/400	200	7000	100,80



ART.	L mm	P mm	H mm	KG	RAL	€
FAN95500001	1494	360	385/400	200	7000	121,80



ART.	L mm	P mm	H mm	KG	RAL	€
FAN95600001	2000	360	385/400	300	7000	172,20





ART.	L mm	P mm	H mm	n. scomparti	RAL	€
FAN1302C00108	608	502	1750	2	7035	272,10



### Tetto inclinato aggiuntivo

ART.	L mm	P mm	H mm	RAL	€
FAN51400008	607	502	220	7035	48,00



ART.	L mm	P mm	H mm	n. scomparti	RAL	€
FAN1303C00108	900	502	1750	3	7035	349,20



### Tetto inclinato aggiuntivo

ART.	L mm	P mm	H mm	RAL	€
FAN51600008	899	502	220	7035	60,30



RAL 7000



RAL 7035



PORTATA



ART.	L mm	P mm	H mm	n. scomparti	RAL	€
FAN1304C00108	1192	502	1750	4	7035	451,20



### Tetto inclinato aggiuntivo

ART.	L mm	P mm	H mm	RAL	€
FAN51800008	1191	502	220	7035	69,60



### Coppia piedini per armadio spogliatoio

ART.	L mm	P mm	H mm	colore	€
FRR23100001	135	500	180/200	Grigio scuro	13,20



ART.	L mm	P mm	H mm	n. scomparti	RAL	€
FAN1502C03108	802	502	1750	2	7035	330,90



### Tetto inclinato aggiuntivo

ART.	L mm	P mm	H mm	RAL	€
FAN51500008	801	502	220	7035	52,80



ART.	L mm	P mm	H mm	n. scomparti	RAL	€
FAN1503C03108	1192	502	1750	3	7035	451,20



### Tetto inclinato aggiuntivo

ART.	L mm	P mm	H mm	RAL	€
FAN51800008	1191	502	220	7035	69,60

# NC

## PORTA UTENSILI



**Cassetti ad estrazione  
totale**



**Armadio portata 1200  
kg**

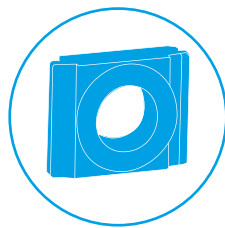

**Vasta gamma di  
boccole**

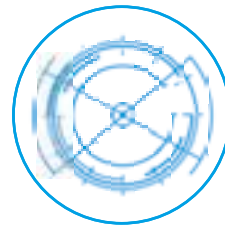

**Configurabile**



ART.	L mm	P mm	H mm	KG	n. coppia telai per armadio	n. coppia telai per cassetto	n. cassetti	n. boccole	tipo boccole	RAL	€
PERFOMNC01	1023	555	2000	1200	2	-	-	84	ISO 40	7035	932,10
PERFOMNC02	1023	555	2000	1200	2	-	-	84	ISO 40	5012	932,10
PERFOMNC03	1023	555	2000	1200	2	-	-	50	ISO 50	7035	845,10
PERFOMNC04	1023	555	2000	1200	2	-	-	50	ISO 50	5012	845,10
PERFOMNC05	1023	555	2000	1200	2	-	-	60	HSK A63-B80	7035	878,10
PERFOMNC06	1023	555	2000	1200	2	-	-	60	HSK A63-B80	5012	878,10
PERFOMNC07	1023	555	2000	1200	1	1	2	84	ISO 40	7035	1105,80
PERFOMNC08	1023	555	2000	1200	1	1	2	84	ISO 40	5012	1105,80
PERFOMNC09	1023	555	2000	1200	1	1	2	50	ISO 50	7035	1018,80
PERFOMNC10	1023	555	2000	1200	1	1	2	50	ISO 50	5012	1018,80
PERFOMNC11	1023	555	2000	1200	1	1	2	60	HSK A63-B80	7035	1051,80
PERFOMNC12	1023	555	2000	1200	1	1	2	60	HSK A63-B80	5012	1051,80



ART.	L mm	P mm	H mm	KG senza ruote	KG setruote	n. telai	n. boccole	tipo boccole	RAL	€
COMBINC01	1064	512	892	500	825	3	35	ISO 40	7035+7000	531,30
COMBINC02	1064	512	892	500	825	3	35	ISO 40	5012+7000	531,30
COMBINC03	1064	512	892	500	825	3	25	ISO 50	7035+7000	508,80
COMBINC04	1064	512	892	500	825	3	25	ISO 50	5012+7000	508,80
COMBINC05	1064	512	892	500	825	3	25	HSK A63-B80	7035+7000	508,80
COMBINC06	1064	512	892	500	825	3	25	HSK A63-B80	5012+7000	508,80



RAL 7035



RAL 5012



RAL 5012+RAL 7000



RAL 7035+RAL 7000







PORTATA



## Telaio porta boccole da banco

ART.	L mm	P mm	H mm	RAL	€
FNC20100008	565	450	351	7035	89,70
FNC20100004	565	450	351	5012	89,70

## Boccola

ART.	tipo	Multiplo d'ordine	q.tà max					€
								
FNC95100003	ISO 30	7	7	21	42	35	21	3,00
FNC95300003	ISO 40	7	7	21	42	35	21	3,00
FNC95400003	ISO 45	6	6	18	30	30	18	3,30
FNC95500003	ISO 50	5	5	15	25	20	15	3,30
FNC95600003	VDI 30	7	7	21	42	35	21	3,30
FNC95700003	VDI 40	5	5	15	30	30	15	3,30
FNC95800003	VDI 50	5	5	15	30	30	15	4,20
FNC95900003	VDI 60	5	5	15	25	20	15	7,20
FNC97200003	CONO MORSE 2	7	7	21	42	35	21	3,30
FNC97300003	CONO MORSE 3	7	7	21	42	35	21	3,30
FNC97400003	CONO MORSE 4	7	7	21	42	35	21	3,30
FNC97500003	CONO MORSE 5	5	5	15	30	30	15	3,30
FNC92700003	CAPTO C3	7	7	21	42	35	21	4,20
FNC92750003	CAPTO C4	5	5	15	30	30	15	4,20
FNC92800003	CAPTO C5	5	5	15	30	30	15	4,20
FNC92850003	CAPTO C6	5	5	15	30	30	15	4,20
FNC92900003	CAPTO C8	5	5	15	20	20	15	4,20
FNC92100003	HSK A32-B40	7	7	21	42	35	21	3,30
FNC92200003	HSK A40-B50	7	7	21	42	35	21	3,30
FNC92300003	HSK A50-B63	5	5	15	30	30	15	3,30
FNC92400003	HSK A63-B80	5	5	15	30	30	15	3,30
FNC92500003	HSK A80-B100	5	5	15	20	20	15	4,20
FNC92600003	HSK A100-B125	5	5	15	20	20	15	4,20
FNC96400003	2"	6	6	18	30	30	18	4,20
FNC96500003	2" 1/4	5	5	15	25	20	15	7,20





### Armadio a porte a battente 54x27 EH

ART.	L mm	P mm	H mm	KG	RAL	€
FAA1420C000PD	1023	555	2000	1200	7035+7016	414,30
FAA1420C00008	1023	555	2000	1200	7035	414,30
FAA1420C00004	1023	555	2000	1200	5012	414,30



### Cassetti ad estrazione telescopica 54x27 EH

ART.	dim. utili			KG	Estrazione	h frontale cassetto	RAL	€
	L mm	P mm	H mm					
FAC9912190008	908	449	85	100	100%	100	7035	96,00
FAC9912190004	908	449	85	100	100%	100	5012	96,00
FAC9912190039	908	449	85	100	100%	100	7016	112,80
FAC9912210008	908	449	135	100	100%	150	7035	108,90
FAC9912210004	908	449	135	100	100%	150	5012	108,90
FAC9912210039	908	449	135	100	100%	150	7016	120,90



### Telaio porta boccole a 3 file per cassetto completo di supporti - confezione 2 pezzi boccole escluse

ART.	L mm	P mm	H mm	RAL	€
FNC5140S101	894	446	142/180	7000	114,60



### Telaio porta boccole a 3 file per armadio - confezione 2 pezzi

ART.	L mm	P mm	H mm	KG	RAL	€
FNC5160S101	965	444	68	150	7000	132,90



RUOTA GIREVOLE



RUOTA GIREVOLE CON FRENO



RUOTA FISSA

### Carrello porta utensili con ruote

ART.	L mm	P mm	H mm	KG senza ruote	ruote						RAL	€
					Ø mm	materiale	KG set ruote					
FCNF1001056	1064	512	892	500	125	Nylon	825	1	1	2	7035+7000	426,30
FCNF1001051	1064	512	892	500	125	Nylon	825	1	1	2	5012+7000	426,30



RAL 7000



RAL 7035



RAL 5012



RAL 7016



RAL 5012 + RAL 7000



RAL 7035 + RAL 7000



RAL 7035 + RAL 7016



PORTATA



ESTRAZIONE

# ECOLOGIA

Le vasche di raccolta prevengono gli sversamenti accidentali di sostanze pericolose ed inquinanti, in ottemperanza al D.Lgs. N.152/2006 e D.Lgs. N.81/2008. Attenzione! Si ricorda di non stoccare nella stessa vasca sostanze chimiche che a contatto tra loro possano reagire e di verificare la compatibilità delle sostanze pericolose stoccate con il materiale di fabbricazione di vasca e griglia. La capacità dei contenitori stoccabili sopra ogni vasca e le informazioni fornite, non esaustive né vincolanti, sono valide per il territorio italiano. Per altri Paesi, attenersi alle disposizioni specifiche vigenti nel Paese di utilizzo e contattare le autorità locali competenti per maggiori informazioni.



**VASCHE DI RACCOLTA + RIPIANI E VASCHE PERFORM IN ACCIAIO**  
Idonee a liquidi infiammabili delle categorie GHS 1 – 3 e liquidi inquinanti per le acque delle categorie GHS 1 – 4.  
Non sono ammesse sostanze corrosive.

**VASCHE DI RACCOLTA IN PE**  
Idonee a liquidi inquinanti per le acque delle categorie GHS 1 – 4.  
Non sono ammesse sostanze infiammabili.



Telaio fornito smontato su paletta

Porta big bag regolabile in altezza

ART.	L mm	P mm	H mm	KG	RAL	€
FAXEBB1002H0004	1090	1084	1205/1395	1000	5012	360,00



- Gambe regolabili in altezza (1205 - 1395 mm) per ospitare big bag di due misure diverse
- Ripiani inferiori lisci per maggiore sostegno al sacco
- Portata testata: 1000 kg
- Sovrapposizione: 1+2 telai
- Possibilità di inserire e sfilare il big bag anche in caso di telai sovrapposti
- Imballo in cartone su pallet non fumigato

 RAL 5012

 PORTATA



**Benna portarottami ribaltabile capacità 300 L con ruote predisposta per griglia e rubinetto**

ART.	L mm	P mm	H mm	L	KG	ruote						RAL	€
						Ø mm	h mm	materiale	KG set ruote	↺	↻		
FAXEPR030060004	1307	800	953	300	600	125	155	Nylon	825	2	2	5012	792,00

Benna fornita smontata

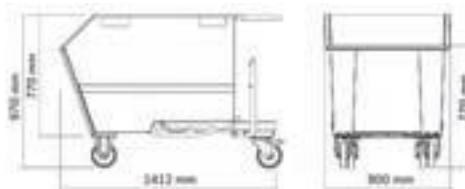

**Benna portarottami ribaltabile capacità 500 L con ruote predisposta per griglia e rubinetto**

ART.	L mm	P mm	H mm	L	KG	ruote						RAL	€
						Ø mm	h mm	materiale	KG set ruote	↺	↻		
FAXEPR050060004	1412	800	970	500	1000	160	200	Nylon	1050	2	2	5012	993,00

Benna fornita smontata

## Rubinetto frontale per lo scarico dei liquidi residui

### Kit rubinetto + griglia

ART.	L mm	P mm	H mm	adatto per	€
FAXEAC001000099	700	388	25	FAXEPR0300600	90,00
FAXEAC003000099	685	388	25	FAXEPR0500600	90,00
FAXEAC002000099	1028	388	25	FAXEPR0750600	108,90



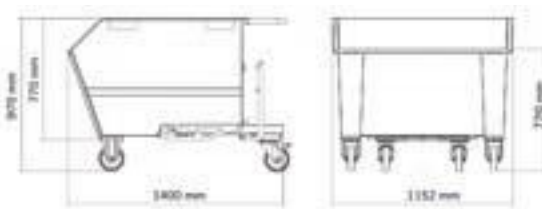

Benna portarottami ribaltabile capacità 750 L con ruote predisposta per griglia e rubinetto

ART.	L mm	P mm	H mm	L	KG	ruote						RAL	€
						Ø mm	h mm	materiale	KG set ruote	☞	☛		
FAXEPR075060004	1400	1152	970	750	1350	160	200	Nylon	1050	2	2	5012	1085,70

⚠ Benna fornita smontata

Cilindro idraulico per il ribaltamento frenato della benna



Cilindro idraulico per benna

ART.	L mm	P mm	H mm	€
FAXEAC004000007	401/671	42	42	95,70



RUOTA GIREVOLE CON FRENO



RUOTA FISSA



RAL 5012



PORTATA



CAPACITÀ





**Vasca conica di raccolta capacità 200 L**

ART.	L mm	P mm	H mm	RAL	€
ECO1302	1310	800	351	5012	356,70

Composto da:

qtà	descrizione
1	Vasca conica di raccolta capacità 200 L
2	Kit 2 doghe
1	Kit 2 pettini per vasca conica



vedi pag. 256

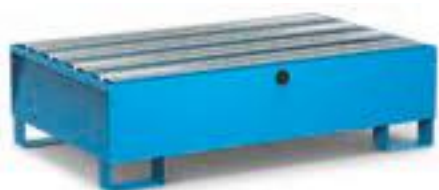

**Vasca di raccolta capacità 200 L**

ART.	L mm	P mm	H mm	RAL	€
ECO1303	1300	805	400	5012	366,30

Composto da:

qtà	descrizione
1	Vasca di raccolta capacità 200 L
2	Kit 2 doghe
1	Kit 2 pettini L=800 mm



vedi pag. 256



**Vasca di raccolta capacità 300 L**

ART.	L mm	P mm	H mm	RAL	€
ECO1304	1300	1205	400	5012	455,40

Composto da:

qtà	descrizione
1	Vasca di raccolta capacità 300 L
3	Kit 2 doghe
1	Kit 2 pettini L=1200 mm



vedi pag. 256





Vasca di raccolta capacità 400 L

ART.	L mm	P mm	H mm	RAL	€
ECO1306	1300	1222	400	5012	483,90

Composto da:

qtà	descrizione
1	Vasca di raccolta capacità 300 L
3	Kit 2 doghe
1	Kit 2 pettini L=1200 mm
1	Kit 2 tappi con guarnizioni

Grazie all'utilizzo del kit tappi la capacità della vasca da 300 litri aumenta a 400 litri



vedi pag. 256

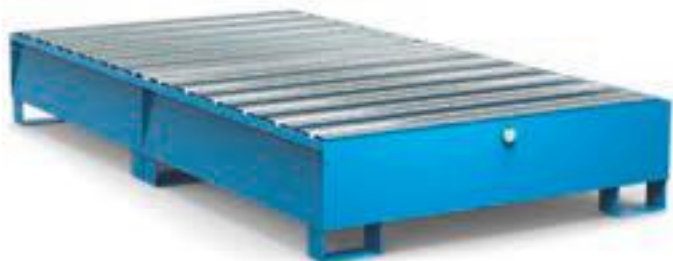

Vasca di raccolta capacità 800 L

ART.	L mm	P mm	H mm	RAL	€
ECO1307	1300	2422	400	5012	967,80

Composto da:

qtà	descrizione
2	Vasca di raccolta capacità 300 L
6	Kit 2 doghe
2	Kit 2 pettini L=1200 mm
1	Kit di accoppiamento vasche
1	Kit 2 tappi con guarnizioni



vedi pag. 256



- Esempio accoppiamento vasche:
1. Kit di accoppiamento vasche (composto da profilo in acciaio zincato salvagoccia e collettore con due guarnizioni)
  2. Kit 2 tappi con guarnizioni



**Vasca di raccolta capacità 300 L con porta fusti**

ART.	L mm	P mm	H mm	RAL	€
ECO1311	1300	1205	787	5012	524,40

Composto da:

qtà	descrizione
1	Vasca di raccolta capacità 300 L
2	Kit 2 doghe
1	Porta fusti per 2 fusti



vedi pag. 256

Fusti esclusi



**Vasca di raccolta capacità 200 L con ruote**

ART.	L mm	P mm	H mm	RAL	€
ECO1308	1491	800	1018	5012+7016	477,60

Composto da:

qtà	descrizione
1	Vasca di raccolta capacità 200 L
2	Kit 2 doghe
1	Kit 2 pettini L=800 mm
1	Maniglia per vasca
1	Kit ruote in nylon Ø 125 mm



vedi pag. 256





Vasca di raccolta capacità 1000 L

ART.	L mm	P mm	H mm	RAL	€
ECO1305	1600	1300	640	5012	911,40

Composto da:

qtà	descrizione
1	Vasca di raccolta capacità 1000 L
4	Kit 2 doghe
2	Kit 2 pettini L=800 mm



Vasca di raccolta capacità 1000 L con telaio

ART.	L mm	P mm	H mm	RAL	€
ECO1309	1600	1306	1065	5012	1072,80

Composto da:

qtà	descrizione
1	Vasca di raccolta capacità 1000 L
4	Kit 2 doghe
1	Telaio per vasca di raccolta



Cisterna esclusa



RUOTA GIREVOLE CON FRENO



RUOTA FISSA



RAL 5012



vedi pag. 256

Cisterne escluse

### Vasca di raccolta capacità 1100 L con telai

ART.	L mm	P mm	H mm	RAL	€
ECO1313	1306	3222	825	5012	1690,50

Composto da:

qtà	descrizione
2	Vasca di raccolta capacità 300 L
1	Vasca di raccolta capacità 200 L
8	Kit 2 doghe
2	Telaio per vasca di raccolta
1	Kit 2 tappi con guarnizioni
2	Kit di accoppiamento vasche

Grazie all'utilizzo del kit tappi la capacità della vasca da 300 litri aumenta a 400 litri, mentre il volume di contenimento della vasca da 200 litri aumenta a 300 litri.



Esempio accoppiamento vasche:

1. Vasca di raccolta capacità 300 L
2. Vasca di raccolta capacità 200 L
3. Kit 2 tappi con guarnizioni
4. Kit di accoppiamento vasche (composto da profilo in acciaio zincato salvagoccia e collettore con due guarnizioni)





vedi pag. 256

Cisterne e fusti esclusi

**Vasca di raccolta capacità 1100 L con telaio e porta fusti**

ART.	L mm	P mm	H mm	RAL	€
ECO1312	1306	3222	825	5012	1590,90

Composto da:

qtà	descrizione
2	Vasca di raccolta capacità 300 L
1	Vasca di raccolta capacità 200 L
7	Kit 2 doghe
1	Porta fusti per 2 fusti
1	Telaio per vasca di raccolta
2	Kit di accoppiamento vasche
1	Kit 2 tappi con guarnizioni





Supporto in polietilene per rialzo

ART.	L mm	P mm	H mm	per fusti		colore	€
				n.	L		
FAX002068000005	465	610	410	1	200	Giallo	148,50
FAX002070000005	1200	780	255	2	200	Giallo	362,40



Vasca di raccolta in polietilene con griglia per fusti

ART.	L mm	P mm	H mm	L	per fusti		colore	€
					n.	L		
FAX002064000005	925	800	420	225	1	200	Giallo	353,10
FAX002065000005	1350	800	420	305	2	200	Giallo	631,50
FAX002066000005	1350	1350	490	500	4	200	Giallo	862,50



vedi pag. 256



Vasca di raccolta in polietilene con griglia per cisterna

ART.	L mm	P mm	H mm	L	per cisterna		colore	€
					n.	L		
FAX002067000005	1350	1350	970	1050	1	1000	Giallo	1242,00



vedi pag. 256







ART.	L mm	P mm	H mm	KG	RAL	€
PERFORM12013	1048	600	1027	800	1004	458,70
PERFORM12014	1048	600	1027	800	7035+7016	458,70
PERFORM12015	1048	600	1027	800	7035	458,70
PERFORM12016	1048	600	1027	800	5012	458,70

Composto da:

qtà	descrizione
1	Armadio con porte a battente fessurate
1	Piano fessurato
1	Vasca stagna esterna di raccolta liquidi capacità 59 L



vedi pag. 256



ART.	L mm	P mm	H mm	KG	RAL	€
PERFORM12017	1023	555	1000	800	1004	438,00
PERFORM12018	1023	555	1000	800	7035+7016	438,00
PERFORM12019	1023	555	1000	800	7035	438,00
PERFORM12020	1023	555	1000	800	5012	438,00

Composto da:

qtà	descrizione
1	Armadio con porte a battente fessurate
1	Kit 2 vasche stagne interne di raccolta liquidi capacità 19 L



vedi pag. 256



ART.	L mm	P mm	H mm	KG	RAL	€
PERFORM12025	1048	600	1027	800	6011	458,70

Composto da:

qtà	descrizione
1	Armadio con porte a battente fessurate
1	Piano fessurato
1	Vasca stagna esterna di raccolta liquidi capacità 59 L



vedi pag. 256



RAL 6011



RAL 1004



RAL 5012



RAL 7035



RAL 7035 + RAL 7016



CAPACITÀ



PORTATA



ART.	L mm	P mm	H mm	KG	RAL	€
<b>PERFORM14056</b>	1048	600	2027	1200	6011	582,00

Composto da:

qtà	descrizione
1	Armadio con porte a battente fessurate
1	Kit 3 piani fessurati
1	Vasca stagna esterna di raccolta liquidi capacità 59 L



vedi pag. 256



ART.	L mm	P mm	H mm	KG	RAL	€
<b>PERFORM14057</b>	1023	555	2000	1200	6011	618,30

Composto da:

qtà	descrizione
1	Armadio con porte a battente fessurate
2	Kit 2 vasche stagne interne di raccolta liquidi capacità 19 L



vedi pag. 256



ART.	L mm	P mm	H mm	KG	RAL	€
<b>PERFORM14058</b>	1023	555	2000	1200	7035	744,00

Composto da:

qtà	descrizione
1	Armadio con porte a battente fessurate in policarbonato
2	Kit 2 vasche stagne interne di raccolta liquidi capacità 19 L



vedi pag. 256



ART.	L mm	P mm	H mm	KG	RAL	€
PERFOM14025	1048	600	2027	1200	1004	582,00
PERFOM14026	1048	600	2027	1200	7035+7016	582,00
PERFOM14027	1048	600	2027	1200	7035	582,00
PERFOM14028	1048	600	2027	1200	5012	582,00

Composto da:

qtà	descrizione
1	Armadio con porte a battente fessurate
1	Kit 3 piani fessurati
1	Vasca stagna esterna di raccolta liquidi capacità 59 L



vedi pag. 256



ART.	L mm	P mm	H mm	KG	RAL	€
PERFOM14029	1023	555	2000	1200	1004	618,30
PERFOM14030	1023	555	2000	1200	7035+7016	618,30
PERFOM14031	1023	555	2000	1200	7035	618,30
PERFOM14032	1023	555	2000	1200	5012	618,30

Composto da:

qtà	descrizione
1	Armadio con porte a battente fessurate
2	Kit 2 vasche stagne interne di raccolta liquidi capacità 19 L



vedi pag. 256



RAL 6011



RAL 1004



RAL 5012



RAL 7035



RAL 7035 + RAL 7016



PORTATA

# CLEVER-COMBI

## CARRELLI



**Facili da montare**



**Portata piani 100  
kg**

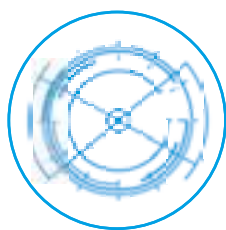

**Configurabile**

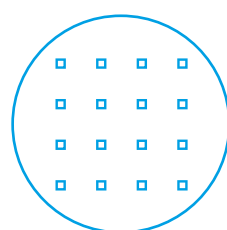

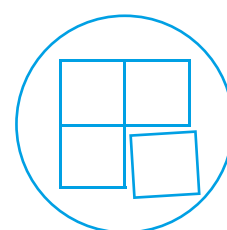

**Fori quadri  
10x10**



**Componibili**

# CLEVER SMALL





ART.	L mm	P mm	H mm	 senza ruote	 set ruote	RAL	€
CLEVER0903	908	515	819	300	225	7035	149,40
CLEVER0904	908	515	819	300	225	5012	149,40

Composto da:

qtà	descrizione
1	Carrello smontato senza ruote
1	Kit ruote in gomma standard Ø 100 mm





ART.	L mm	P mm	H mm	 senza ruote	 set ruote	RAL	€
CLEVER0905	908	515	819	300	225	7035	189,60
CLEVER0906	908	515	819	300	225	5012	189,60

Composto da:

qtà	descrizione
1	Carrello smontato senza ruote
1	Piano aggiuntivo
1	Kit ruote in gomma standard Ø 100 mm



ART.	L mm	P mm	H mm	 senza ruote	 set ruote	RAL	€
CLEVER0907	908	515	846	300	300	7035	198,90
CLEVER0908	908	515	846	300	300	5012	198,90

Composto da:

qtà	descrizione
1	Carrello smontato senza ruote
1	Piano aggiuntivo
1	Kit ruote in gomma antitraccia sintetica Ø 125 mm

  
RAL 7035

  
RAL 5012

 PORTATA

# CLEVER LARGE





ART.	L mm	P mm	H mm	 senza ruote	 set ruote	RAL	€
<b>CLEVER1003</b>	1028	615	819	300	225	7035	167,70
<b>CLEVER1004</b>	1028	615	819	300	225	5012	167,70

Composto da:

qtà	descrizione
1	Carrello smontato senza ruote
1	Kit ruote in gomma standard Ø 100 mm



ART.	L mm	P mm	H mm	 senza ruote	 set ruote	RAL	€
<b>CLEVER1005</b>	1028	615	846	300	300	7035	220,50
<b>CLEVER1006</b>	1028	615	846	300	300	5012	220,50

Composto da:

qtà	descrizione
1	Carrello smontato senza ruote
1	Piano aggiuntivo
1	Kit ruote in gomma standard Ø 125 mm



ART.	L mm	P mm	H mm	 senza ruote	 set ruote	RAL	€
<b>CLEVER1007</b>	1028	615	846	300	300	7035	225,00
<b>CLEVER1008</b>	1028	615	846	300	300	5012	225,00

Composto da:

qtà	descrizione
1	Carrello smontato senza ruote
1	Piano aggiuntivo
1	Kit ruote in gomma antitraccia sintetica Ø 125 mm



# CLEVER LARGE



ART.	L mm	P mm	H mm	 senza ruote	 set ruote	RAL	€
<b>CLEVER1009</b>	1028	615	868	300	300	7035	280,20
<b>CLEVER1010</b>	1028	615	868	300	300	5012	280,20

Composto da:

qtà	descrizione
1	Carrello smontato senza ruote
1	Piano in legno con supporti
1	Kit ruote in gomma antitraccia sintetica Ø 125 mm





ART.	L mm	P mm	H mm	 senza ruote	 set ruote	RAL	€
<b>CLEVER1011</b>	1030	615	846	300	300	7035	297,00
<b>CLEVER1012</b>	1030	615	846	300	300	5012	297,00

Composto da:

qtà	descrizione
1	Carrello smontato senza ruote
1	Piano aggiuntivo
2	Pannello laterale forato
1	Kit ruote in gomma antitraccia sintetica Ø 125 mm



ART.	L mm	P mm	H mm	 senza ruote	 set ruote	RAL	€
<b>CLEVER1013</b>	1030	615	868	300	300	7035	352,20
<b>CLEVER1014</b>	1030	615	868	300	300	5012	352,20

Composto da:

qtà	descrizione
1	Carrello smontato senza ruote
1	Piano in legno con supporti
2	Pannello laterale forato
1	Kit ruote in gomma antitraccia sintetica Ø 125 mm

  
RAL 7035

  
RAL 5012

  
PORTATA

# CLEVER LARGE



ART.	L mm	P mm	H mm	KG		RAL	€
				senza ruote	set ruote		
<b>CLEVER1015</b>	1030	630	868	300	300	7035	403,20
<b>CLEVER1016</b>	1030	630	868	300	300	5012	403,20

Composto da:

qtà	descrizione
1	Carrello smontato senza ruote
1	Piano in legno con supporti
2	Pannello laterale forato
1	Pannello posteriore forato
1	Kit ruote in gomma antitraccia sintetica Ø 125 mm



ART.	L mm	P mm	H mm	KG		RAL	€
				senza ruote	set ruote		
<b>CLEVER1017</b>	1030	655	868	300	300	7035	551,70
<b>CLEVER1018</b>	1030	655	868	300	300	5012	551,70

Composto da:

qtà	descrizione
1	Carrello smontato senza ruote
1	Piano in legno con supporti
2	Pannello laterale forato
1	Pannello posteriore forato
1	Coppia porte a battente
1	Kit ruote in gomma antitraccia sintetica Ø 125 mm



ART.	L mm	P mm	H mm	KG		RAL	€
				senza ruote	set ruote		
<b>CLEVER1019</b>	1028	615	846	300	300	7035+7016	325,50
<b>CLEVER1020</b>	1028	615	846	300	300	5012	321,00

Composto da:

qtà	descrizione
1	Carrello smontato senza ruote
1	Piano aggiuntivo
1	Armadio L=500 mm con 1 cassetto H=150 mm
1	Kit ruote in gomma antitraccia sintetica Ø 125 mm

# CLEVER LARGE





ART.	L mm	P mm	H mm	 senza ruote	 set ruote	RAL	€
<b>CLEVER1021</b>	1030	633	1538	300	300	7035	436,20
<b>CLEVER1022</b>	1030	633	1538	300	300	5012	436,20

Composto da:

qtà	descrizione
1	Carrello smontato senza ruote
1	Piano in legno con supporti
2	Pannello laterale forato
1	Pannello posteriore forato
1	Coppia montanti per fissaggio pannello
1	Kit ruote in gomma antitraccia sintetica Ø 125 mm



ART.	L mm	P mm	H mm	 senza ruote	 set ruote	RAL	€
<b>CLEVER1023</b>	1030	658	1538	300	300	7035	635,70
<b>CLEVER1024</b>	1030	658	1538	300	300	5012	635,70

Composto da:

qtà	descrizione
1	Carrello smontato senza ruote
1	Piano in legno con supporti
2	Pannello laterale forato
2	Pannello posteriore forato
1	Coppia montanti per fissaggio pannello
1	Coppia porte a battente
1	Kit ruote in gomma antitraccia sintetica Ø 125 mm



ART.	L mm	P mm	H mm	 senza ruote	 set ruote	RAL	€
<b>CLEVER1025</b>	1028	654	1538	300	300	7035+7016	464,70
<b>CLEVER1026</b>	1028	654	1538	300	300	5012	460,20

Composto da:

qtà	descrizione
1	Carrello smontato senza ruote
1	Piano in legno con supporti
1	Pannello posteriore forato
1	Coppia montanti per fissaggio pannello
1	Armadio L=500 mm con 1 cassetto H=150 mm
1	Kit ruote in gomma antitraccia sintetica Ø 125 mm



RAL 7035 + RAL 7016



RAL 7035





RAL 5012



PORTATA

# CLEVER LARGE



ART.	Lmm	Pmm	Hmm	 senza ruote	 set ruote	RAL	€
CLEVER1027	1347	633	1538	300	300	7035	674,40
CLEVER1028	1347	633	1538	300	300	5012	674,40

Composto da:

qtà	descrizione
1	Carrello smontato senza ruote
1	Piano in legno con supporti
2	Pannello laterale forato
1	Pannello posteriore forato
1	Coppia montanti per fissaggio pannello
1	Mensola grande reversibile
1	Barra aggancio con 3 contenitori Picking Box misura 2
1	Porta bombolette a 6 posti
2	Porta silicone inclinato a 2 posti
1	Kit porta rotolo con carta Ø=240 mm
2	Calamita completa di clip e vite - confezione 10 pezzi
1	Kit ruote in gomma antitraccia sintetica Ø 125 mm



Carrello smontato senza ruote

ART.	L mm	P mm	H mm	KG	RAL	€
FCR10S0X208	908	515	691	300	7035	105,30
FCR10S0X204	908	515	691	300	5012	105,30
FCR11S0X208	1028	615	691	300	7035	123,60
FCR11S0X204	1028	615	691	300	5012	123,60



Kit ruote

ART.	Ø mm	KG	KG	H mm	materiale	🔄	🛑	€
FKRD1002107	100	75	225	128	Gomma standard	2	2	44,10
FKRB1252107	125	100	300	155	Gomma standard	2	2	48,90
FKRU1252101	125	100	300	155	Gomma antitraccia sintetica	2	2	53,40
FKRS1252101	125	250	750	155	Gomma elastica	2	2	85,20



Piano aggiuntivo

ART.	L mm	P mm	H mm	adatto per	KG	RAL	€
FCR10120108	810	510	35	Carrello Clever Small	100	7035	40,20
FCR10120104	810	510	35		100	5012	40,20
FCR11120108	930	610	35	Carrello Clever Large	100	7035	48,00
FCR11120104	930	610	35		100	5012	48,00



RUOTA GIREVOLE CON FRENO



RUOTA FISSA



PORTATA



RAL 7035



RAL 5012



**Pannello posteriore forato**

ART.	L mm	P mm	H mm	adatto per	Dim. foro mm	Passo mm	RAL	€
FCR11150108	895	22	690	Carrello Clever Large	10x10	38	7035	51,00
FCR11150104	895	22	690		10x10	38	5012	51,00

**!** Per l'installazione sulla parte superiore del carrello è necessario ordinare la coppia montanti



**Coppia montanti per fissaggio pannello**

ART.	L mm	P mm	H mm	RAL	€
FCR10170139	45	35	650	7016	33,00

**!** Per l'installazione sulla parte superiore del carrello è necessario ordinare la coppia montanti



**Coppia porte a battente**

ART.	L mm	P mm	H mm	adatto per	Dim. foro mm	Passo mm	RAL	€
FCR11160108	936	44	690	Carrello Clever Large	10x10	38	7035	148,50
FCR11160104	936	44	690		10x10	38	5012	148,50



**Pannello laterale forato**

ART.	L mm	P mm	H mm	adatto per	Dim. foro mm	Passo mm	RAL	€
FCR11140108	573	7	688	Carrello Clever Large	10x10	38	7035	36,00
FCR11140104	573	7	688		10x10	38	5012	36,00





Piano in legno con supporti

ART.	L mm	P mm	H mm	adatto per	KG	€
FCR11130100	930	610	51	Carrello Clever Large	100	103,20



Armadio L=500 mm con 1 cassetto H=150 mm

ART.	L mm	P mm	H mm	KG	RAL	€
FBG03S50C0001PD	500	630	210	80	7035+7016	100,50
FBG03S50C000104	500	630	210	80	5012	96,00

# IRONTEAM

vedi pag. 90



FBL95410000

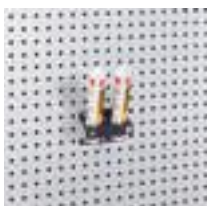

FBLIT008039



FBLIT004039



FBLIT010039



FBLIT013000



FBLIT017039



FBLET012007



FBLET004007



FBLET005007



FBLET016007



RAL 7016



RAL 7035 + RAL 7016



RAL 7035





RAL 5012



PORTATA

# CLEVER LARGE



ART.	L mm	P mm	H mm	 senza ruote	 set ruote	RAL	€
CLEVER1029	1347	658	1538	300	300	7035	1039,20
CLEVER1030	1347	658	1538	300	300	5012	1039,20

Composto da:

qtà	descrizione
1	Carrello smontato senza ruote
1	Piano in legno con supporti
2	Pannello laterale forato
2	Pannello posteriore forato
1	Coppia montanti per fissaggio pannello
1	Coppia porte a battente
1	Kit porta rotolo con carta Ø=240 mm
1	Porta bombolette a 6 posti
2	Mensola grande reversibile
1	Cestino capacità 30 L
1	Cavo di collegamento wieland schuko/francese
1	Multipresa schuko a 4 scomparti
1	Multipresa schuko a 2 scomparti
1	Supporto multipresa a 4 scomparti
1	Supporto multipresa a 2 scomparti
2	Calamita completa di clip e vite - confezione 10 pezzi
1	Kit ruote in gomma antitraccia sintetica Ø 125 mm



**Carrello con base in acciaio con ruote**

ART.	L mm	P mm	H mm	 senza ruote	ruote						RAL	€
					Ø mm	materiale	 set ruote					
FCEP1052004	1095	700	1000	500	200	Gomma standard	615	1	1	2	5012	323,40





**Carrello con base in acciaio con ruote**

ART.	L mm	P mm	H mm	 senza ruote	ruote						RAL	€
					Ø mm	materiale	 set ruote					
FCEB1050308	1135	700	915	500	125	Gomma standard	300	1	1	2	7035	174,00
FCEB1050304	1135	700	915	500	125	Gomma standard	300	1	1	2	5012	174,00



**Carrello con base in acciaio con ruote**

ART.	L mm	P mm	H mm		ruote		RAL	€
					Ø mm			
FCR00210008	555	445	845	150	100	4	7035	131,10
FCR00210004	555	445	845	150	100	4	5012	131,10



RUOTA GIREVOLE CON FRENO



RUOTA GIREVOLE



RUOTA FISSA



RAL 7035



RAL 5012



PORTATA

# BIN CART

## CARRELLI componibili multiuso



**Facili da montare**



**Portata carrello 300  
kg**

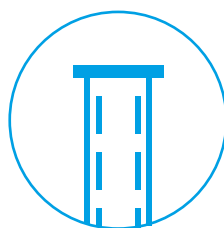

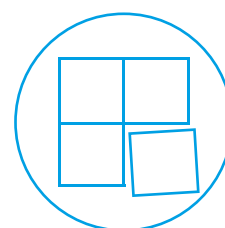

**Montante forato  
passo 38 mm**



**Componibili**

# BIN CART



ART.	L mm	P mm	H mm	 senza ruote	 set ruote	RAL	€
<b>BINCART1001</b>	1067	668	1357	300	300	7016	560,40

Composto da:

qtà	descrizione
1	Carrello smontato senza ruote
2	Set 5 profili con 90 contenitori Picking Box misura 1
1	Kit ruote in gomma antitraccia sintetica Ø 125 mm



ART.	L mm	P mm	H mm	 senza ruote	 set ruote	RAL	€
<b>BINCART1002</b>	1067	668	1357	300	300	7016	530,40

Composto da:

qtà	descrizione
1	Carrello smontato senza ruote
1	Set 5 profili con 90 contenitori Picking Box misura 1
1	Set 4 profili con 48 contenitori Picking Box misura 2
1	Kit ruote in gomma antitraccia sintetica Ø 125 mm



ART.	L mm	P mm	H mm	 senza ruote	 set ruote	RAL	€
<b>BINCART1003</b>	1067	668	1357	300	300	7016	500,40

Composto da:

qtà	descrizione
1	Carrello smontato senza ruote
2	Set 4 profili con 48 contenitori Picking Box misura 2
1	Kit ruote in gomma antitraccia sintetica Ø 125 mm



  
RAL 7016

 PORTATA



# BIN CART



ART.	L mm	P mm	H mm	 senza ruote	 set ruote	RAL	€
<b>BINCART0701</b>	761	668	1357	300	300	7016	739,80

Composto da:

qtà	descrizione
1	Carrello smontato senza ruote
2	Coppia supporti totali per Visual Box
2	Profilo in alluminio per Picking Box
2	Cassetteria Visual Box con 3 cassetti H=240 mm
2	Cassetteria Visual Box con 4 cassetti H=206 mm
4	Cassetteria Visual Box con 5 cassetti H=164 mm



qtà	descrizione
6	Cassetteria Visual Box con 6 cassetti H=112 mm
2	Fermo per cassetteria Visual Box con 3 cassetti
2	Fermo per cassetteria Visual Box con 4 cassetti
4	Fermo per cassetteria Visual Box con 5 cassetti
6	Fermo per cassetteria Visual Box con 6 cassetti
1	Kit ruote in gomma antitraccia sintetica Ø 125 mm





# BIN CART



ART.	L mm	P mm	H mm	 senza ruote	 set ruote	RAL	€
<b>BINCART1007</b>	1067	668	1543	300	300	7016	457,50

Composto da:

qtà	descrizione
1	Carrello smontato senza ruote
1	Coppia piastre di supporto per profilo in alluminio
3	Profilo in alluminio per Picking Box
1	Pannello forato/mensola con 1 bordo fermacasse
1	Pensile con porta
3	Barra aggancio con 4 contenitori Picking Box misura 1
1	Kit ruote in gomma antitraccia sintetica Ø 125 mm



ART.	L mm	P mm	H mm	 senza ruote	 set ruote	RAL	€
<b>BINCART1006</b>	1067	668	1965	300	300	7016	384,90

Composto da:

qtà	descrizione
1	Carrello smontato senza ruote
2	Coppia piastre di supporto per profilo in alluminio
6	Profilo in alluminio per Picking Box
1	Kit ruote in gomma antitraccia sintetica Ø 125 mm





RAL 7016



PORTATA

# BIN CART



ART.	L mm	P mm	H mm	 senza ruote	 set ruote	RAL	€
<b>BINCART0704</b>	761	668	1357	300	300	7016	355,80

Composto da:

qtà	descrizione
1	Carrello smontato senza ruote
4	Pannello forato/mensola con 1 bordo fermacasse
1	Kit ruote in gomma antitraccia sintetica Ø 125 mm



ART.	L mm	P mm	H mm	 senza ruote	 set ruote	RAL	€
<b>BINCART1008</b>	1067	668	1357	300	300	7016	423,60

Composto da:

qtà	descrizione
1	Carrello smontato senza ruote
4	Pannello forato/mensola con 1 bordo fermacasse
1	Kit ruote in gomma antitraccia sintetica Ø 125 mm



ART.	L mm	P mm	H mm	 senza ruote	 set ruote	RAL	€
<b>BINCART1501</b>	1552	668	1357	300	300	7016	526,50

Composto da:

qtà	descrizione
1	Carrello smontato senza ruote
4	Pannello forato/mensola con 1 bordo fermacasse
1	Kit ruote in gomma antitraccia sintetica Ø 125 mm

# BIN CART



ART.	L mm	P mm	H mm	 senza ruote	 set ruote	RAL	€
<b>BINCART0705</b>	761	668	1965	300	300	7016	481,20

Composto da:

qtà	descrizione
1	Carrello smontato senza ruote
6	Pannello forato/mensola con 1 bordo fermacasse
1	Kit ruote in gomma antitraccia sintetica Ø 125 mm



ART.	L mm	P mm	H mm	 senza ruote	 set ruote	RAL	€
<b>BINCART1009</b>	1067	668	1965	300	300	7016	578,70

Composto da:

qtà	descrizione
1	Carrello smontato senza ruote
6	Pannello forato/mensola con 1 bordo fermacasse
1	Kit ruote in gomma antitraccia sintetica Ø 125 mm



ART.	L mm	P mm	H mm	 senza ruote	 set ruote	RAL	€
<b>BINCART1502</b>	1552	668	1965	300	300	7016	709,80

Composto da:



qtà	descrizione
1	Carrello smontato senza ruote
6	Pannello forato/mensola con 1 bordo fermacasse
1	Kit ruote in gomma antitraccia sintetica Ø 125 mm

  
RAL 7016

  
PORTATA

# BIN CART



ART.	L mm	P mm	H mm	 senza ruote	 set ruote	RAL	€
<b>BINCART0706</b>	761	668	1965	300	300	7016	401,70

Composto da:

qtà	descrizione
1	Carrello smontato senza ruote
2	Pannello forato/mensola con 1 bordo fermacasse
1	Profilo in alluminio per Picking Box
10	Gancio porta cavi P=171 mm
1	Kit ruote in gomma antitraccia sintetica Ø 125 mm



ART.	L mm	P mm	H mm	 senza ruote	 set ruote	RAL	€
<b>BINCART1010</b>	1067	668	1965	300	300	7016	444,00

Composto da:

qtà	descrizione
1	Carrello smontato senza ruote
2	Pannello forato/mensola con 1 bordo fermacasse
1	Profilo in alluminio per Picking Box
10	Gancio porta cavi P=171 mm
1	Kit ruote in gomma antitraccia sintetica Ø 125 mm



ART.	L mm	P mm	H mm	 senza ruote	 set ruote	RAL	€
<b>BINCART1503</b>	1552	668	1965	300	300	7016	504,90



Composto da:

qtà	descrizione
1	Carrello smontato senza ruote
2	Pannello forato/mensola con 1 bordo fermacasse
1	Profilo in alluminio per Picking Box
10	Gancio porta cavi P=171 mm
1	Kit ruote in gomma antitraccia sintetica Ø 125 mm



# BIN CART





ART.	L mm	P mm	H mm	 senza ruote	 set ruote	RAL	€
<b>BINCART0707</b>	761	668	1357	300	300	7016	276,30

Composto da:

qtà	descrizione
1	Carrello smontato senza ruote
1	Profilo in alluminio per Picking Box
10	Gancio porta cavi P=171 mm
1	Kit ruote in gomma antitraccia sintetica Ø 125 mm



ART.	L mm	P mm	H mm	 senza ruote	 set ruote	RAL	€
<b>BINCART1011</b>	1067	668	1357	300	300	7016	288,90

Composto da:

qtà	descrizione
1	Carrello smontato senza ruote
1	Profilo in alluminio per Picking Box
10	Gancio porta cavi P=171 mm
1	Kit ruote in gomma antitraccia sintetica Ø 125 mm

Attrezzatura esclusa



ART.	L mm	P mm	H mm	 senza ruote	 set ruote	RAL	€
<b>BINCART1504</b>	1552	668	1357	300	300	7016	321,60

Composto da:

qtà	descrizione
1	Carrello smontato senza ruote
1	Profilo in alluminio per Picking Box
10	Gancio porta cavi P=171 mm
1	Kit ruote in gomma antitraccia sintetica Ø 125 mm





  
RAL 7016

  
PORTATA

# BIN CART



ART.	L mm	P mm	H mm	 senza ruote	 set ruote	RAL	€
<b>BINCART0708</b>	761	668	1357	300	300	7016	372,60

Composto da:

qtà	descrizione
1	Carrello smontato senza ruote
2	Profilo in alluminio per Picking Box
6	Coppia supporti P=266 mm
1	Kit ruote in gomma antitraccia sintetica Ø 125 mm



ART.	L mm	P mm	H mm	 senza ruote	 set ruote	RAL	€
<b>BINCART1012</b>	1067	668	1357	300	300	7016	390,00

Composto da:

qtà	descrizione
1	Carrello smontato senza ruote
2	Profilo in alluminio per Picking Box
6	Coppia supporti P=266 mm
1	Kit ruote in gomma antitraccia sintetica Ø 125 mm

Attrezzatura esclusa



ART.	L mm	P mm	H mm	 senza ruote	 set ruote	RAL	€
<b>BINCART1505</b>	1552	668	1357	300	300	7016	431,70

Composto da:



qtà	descrizione
1	Carrello smontato senza ruote
2	Profilo in alluminio per Picking Box
6	Coppia supporti P=266 mm
1	Kit ruote in gomma antitraccia sintetica Ø 125 mm





# BIN CART





ART.	L mm	P mm	H mm	 senza ruote	 set ruote	RAL	€
<b>BINCART0709</b>	761	668	1965	300	300	7016	452,40

Composto da:

qtà	descrizione
1	Carrello smontato senza ruote
1	Pannello forato/mensola con 1 bordo fermacasse
1	Kit porta rotolo con carta Ø=240 mm
1	Mensola piccola reversibile
2	Profilo in alluminio per Picking Box
3	Coppia supporti P=421 mm
1	Kit ruote in gomma antitraccia sintetica Ø 125 mm





ART.	L mm	P mm	H mm	 senza ruote	 set ruote	RAL	€
<b>BINCART1013</b>	1067	668	1965	300	300	7016	616,80

Composto da:

qtà	descrizione
1	Carrello smontato senza ruote
1	Pannello forato/mensola con 1 bordo fermacasse
2	Pensile con porta
2	Profilo in alluminio per Picking Box
3	Coppia supporti P=421 mm
1	Kit ruote in gomma antitraccia sintetica Ø 125 mm



ART.	L mm	P mm	H mm	 senza ruote	 set ruote	RAL	€
<b>BINCART1506</b>	1552	668	1965	300	300	7016	613,50

Composto da:

qtà	descrizione
1	Carrello smontato senza ruote
1	Pannello forato/mensola con 1 bordo fermacasse
1	Pensile con porta
2	Mensola grande reversibile
2	Profilo in alluminio per Picking Box
3	Coppia supporti P=421 mm
1	Kit ruote in gomma antitraccia sintetica Ø 125 mm





  
RAL 7016

  
PORTATA

# BIN CART



ART.	L mm	P mm	H mm	 senza ruote	 set ruote	RAL	€
<b>BINCART1005</b>	1067	668	1677	300	300	7016	476,40

Composto da:

qtà	descrizione
1	Carrello smontato senza ruote
3	Pannello non forato/mensola
1	Pannello forato/mensola con 1 bordo fermacasse
1	Coppia squadrette a L
1	Snodo per piastra



qtà	descrizione
1	Piastra porta monitor con standard VESA
1	Supporto multipresa a 4 scomparti
1	Multipresa schuko a 4 scomparti
1	Cavo di collegamento wieland schuko/francese
1	Kit ruote in gomma antitraccia sintetica Ø 125 mm

# BIN CART



Contenitori esclusi



ART.	L mm	P mm	H mm	 senza ruote	 set ruote	RAL	€
<b>BINCART1004</b>	1067	668	1357	300	300	7016	382,50

Composto da:

qtà	descrizione
1	Carrello smontato senza ruote
3	Pannello forato/mensola con 1 bordo fermacasse
1	Profilo in alluminio per Picking Box
1	Kit ruote in gomma antitraccia sintetica Ø 125 mm



  
RAL 7016

  
PORTATA

# BIN CART



Banco escluso

ART.	L mm	P mm	H mm	 senza ruote	 set ruote	RAL	€
<b>BINCART1014</b>	2513	850	2267	300	300	7016	1116,60

Composto da:

qtà	descrizione
1	Carrello smontato senza ruote
1	Kit 2 supporti inclinati con binario
1	Lampada doppia
3	Pannello forato/mensola con 1 bordo fermacasse
4	Kit 2 contenitori Picking Box misura 3A2
2	Braccio estensibile per montante

qtà	descrizione
2	Piastra porta monitor con standard VESA
1	Pannello per Picking Box
5	Barra aggancio con 4 contenitori Picking Box misura 1
1	Pannello per Visual Box
2	Cassetiera Visual Box con 6 cassetti H=112 mm
1	Cassetiera Visual Box con 5 cassetti H=164 mm
1	Kit ruote in gomma antitraccia sintetica Ø 125 mm

# BIN CART



Banco escluso

ART.	L mm	P mm	H mm	 senza ruote	 set ruote	RAL	€
<b>BINCART1507</b>	2998	850	2267	300	300	7016	1213,20

Composto da:

qtà	descrizione
1	Carrello smontato senza ruote
3	Pannello forato/mensola con 1 bordo fermacasse
1	Kit 2 supporti inclinati con binario
1	Lampada doppia
2	Braccio estensibile per montante
2	Piastra porta monitor con standard VESA
1	Pannello per Picking Box

qtà	descrizione
4	Barra aggancio con 4 contenitori Picking Box misura 1
1	Pannello per Visual Box
2	Cassettiera Visual Box con 6 cassette H=112 mm
1	Cassettiera Visual Box con 5 cassette H=164 mm
18	Contenitore in polipropilene Picking Box misura 2
3	Kit 2 contenitori Picking Box misura 3A2
1	Kit ruote in gomma antitraccia sintetica Ø 125 mm

  
RAL 7016

  
PORTATA



**Carrello smontato senza ruote**

ART.	L mm	P mm	H mm	KG	KG per lato	RAL	€
FBC10070039	709	668	1201	300	150	7016	117,60
FBC15070039	709	668	1809	300	150	7016	150,60



**Profilo in alluminio per Picking Box**

ART.	L mm	P mm	H mm	materiale	KG	€
FBC25070000	705	35	60	Alluminio	40	15,30



**Coppia supporti parziali per Visual Box**

ART.	L mm	P mm	H mm	KG	RAL	€
FBC30070139	649	50	319	75	7016	22,50



**Coppia supporti totali per Visual Box**

ART.	L mm	P mm	H mm	KG	RAL	€
FBC30070239	649	50	1153	150	7016	40,50





**Pannello non forato/mensola**

Può essere utilizzato come chiusura della base del carrello

ART.	L mm	P mm	H mm	 KG	RAL	€
<b>FBL76580008</b>	647	31	494	50	7035	36,00

**Pannello forato/mensola con 1 bordo fermacasse**

ART.	L mm	P mm	H mm	Dim. foro mm	Passo mm	RAL	€
<b>FBL76080108</b>	647	60	456	10x10	38	7035	46,20
<b>FBL76080104</b>	647	60	456	10x10	38	5012	46,20

**Visual Box**

**Cassettiera Visual Box**

ART.	multiplo d'ordine	dim. ingombro			cassetti			colore	€	
		L mm	P mm	H mm	n.	L mm	P mm			H mm
FAXVBCH00900001	2	600	69	77	9	59	44	49	Grigio scuro	16,80
FAXVBCH00600001	2	600	98	112	6	87	66	72	Grigio scuro	20,40
FAXVBCH00500001	1	600	141	164	5	113	100	110	Grigio scuro	32,40
FAXVBCH00400001	1	600	174	206	4	142	130	135	Grigio scuro	42,30
FAXVBCH00300001	1	600	209	240	3	190	146	164	Grigio scuro	47,70

**Fermo per cassettera Visual Box**

ART.	adatto per	€
FAXVBCHL0900099	FAXVBCH0090000	1,80
FAXVBCHL0600099	FAXVBCH0060000	1,80
FAXVBCHL0500099	FAXVBCH0050000	1,80
FAXVBCHL0400099	FAXVBCH0040000	1,80
FAXVBCHL0300099	FAXVBCH0030000	1,80



RAL 7016



RAL 7035





RAL 5012



PORTATA

**Carrello smontato senza ruote**

ART.	L mm	P mm	H mm	 KG	 KG per lato	RAL	€
<b>FBC10100039</b>	1015	668	1201	300	150	7016	125,40
<b>FBC15100039</b>	1015	668	1809	300	150	7016	158,10

**Profilo in alluminio per Picking Box**

ART.	L mm	P mm	H mm	materiale	 KG	€
<b>FBC25100000</b>	1011	35	60	Alluminio	40	20,10

**Pannello non forato/mensola**

Può essere utilizzato come chiusura della base del carrello

ART.	L mm	P mm	H mm	 KG	RAL	€
<b>FBL76680008</b>	953	31	494	50	7035	45,60

**Pannello forato/mensola con 1 bordo fermacasse**

ART.	L mm	P mm	H mm	Dim. foro mm	Passo mm	RAL	€
<b>FBL76170108</b>	953	60	456	10x10	38	7035	61,20
<b>FBL76170104</b>	953	60	456	10x10	38	5012	61,20



Set 4 profili con 48 contenitori Picking Box misura 2

ART.	per carrello L mm	contenitori mis.	colore	€
FBC25100201	1015	2	Grigio scuro	160,80



Set 5 profili con 90 contenitori Picking Box misura 1

ART.	per carrello L mm	contenitori mis.	colore	€
FBC25100101	1015	1	Grigio scuro	190,80



Coppia piastre di supporto per profilo in alluminio

ART.	L mm	P mm	H mm	KG	RAL	€
FBC40100039	524	104	3	80	7016	26,40



1. Profilo in alluminio per Picking Box
2. Coppia piastre di supporto per profilo in alluminio
3. Gancio porta cavi P=221 mm



RAL 7016



RAL 7035





RAL 5012



PORTATA

**Carrello smontato senza ruote**

ART.	L mm	P mm	H mm	 KG	 KG per lato	RAL	€
<b>FBC10150039</b>	1500	668	1201	300	150	7016	149,10
<b>FBC15150039</b>	1500	668	1809	300	150	7016	170,40

**Profilo in alluminio per Picking Box**

ART.	L mm	P mm	H mm	per carrello L mm	 KG	per contenitori mis.	materiale	€
<b>FBC25150000</b>	1496	35	60	1500	40	1/2	Alluminio	29,10

**Pannello forato/mensola con 1 bordo fermacasse**

ART.	L mm	P mm	H mm	Dim. foro mm	Passo mm	RAL	€
<b>FBL76320108</b>	1438	60	456	10x10	38	7035	81,00
<b>FBL76320104</b>	1438	60	456	10x10	38	5012	81,00

## L= 700 MM

## L= 1000 MM

## L= 1500 MM



### Gancio porta cavi

ART.	L mm	P mm	H mm	KG	€
FBC35100099	28	171	84	10	9,00
FBC35150099	28	221	84	10	9,30
FBC35200099	28	271	84	10	9,90



### Coppia supporti

ART.	dim. ingombro			dim. utili	KG	RAL	€
	L mm	P mm	H mm	P mm			
FBC45030008	36	300	136	266	70	7035	28,50
FBC45040008	36	455	136	421	50	7035	33,30



### Kit ruote

ART.	Ø mm	KG	KG	H mm	materiale	↺	↻	€
FKRD1002107	100	75	225	128	Gomma standard	2	2	44,10
FKRB1252107	125	100	300	155	Gomma standard	2	2	48,90
FKRU1252101	125	100	300	155	Gomma antitraccia sintetica	2	2	53,40
FKRS1252101	125	250	750	155	Gomma elastica	2	2	85,20

# IRONTEAM

vedi pag.90



FBL95410000



FBLIT008039



FBLIT004039



FBLIT010039



FBLIT013000



FBLIT017039



FBLET012007



FBLET004007



FBLET005007



FBLET016007



RUOTA GIREVOLE CON FRENO



RUOTA FISSA



RAL 7016



RAL 7035



RAL 5012



PORTATA



# ST

## SCAFFALI



**Facili da montare**

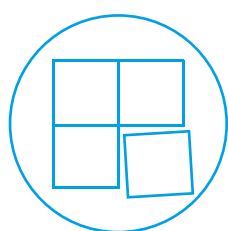

**Componibili**

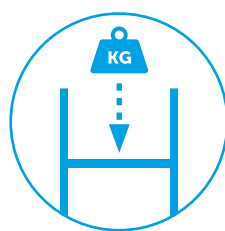

**Portata piani fino a  
300 kg**



**Portata campata 2300  
kg**



# SYSTEM ST



ART.	L mm	P mm	H mm	finitura	€
ST2001	2115	523	2003	Zincato	374,70

qtà	descrizione
3	Fiancata con 3 traversini
2	Kit 5 piani fessurati



ART.	L mm	P mm	H mm	finitura	€
ST2601	2715	423	2003	Zincato	289,80

qtà	descrizione
3	Fiancata con 3 traversini
2	Kit 3 coppie supporti porta pneumatici



## Kit 5 rinforzi per piani fessurati

ART.	L mm	P mm	H mm	finitura	€
FUF20000199	993	50	33	Zincato	24,90

## Kit 3 coppie supporti porta pneumatici

ART.	L mm	P mm	H mm	 KG	finitura	€
FST95900199	1300	32	100	50	Zincato	77,40

## Kit 5 piani fessurati

ART.	L mm	P mm	H mm	 KG	finitura	€
FST10402099	1000	400	35	120	Zincato	108,30
FST10502099	1000	500	35	120	Zincato	117,60

## Fiancata con traversini

ART.	P mm	H mm	finitura	€
FST02034099	423	2003	Zincato	45,00
FST02035099	523	2003	Zincato	46,50

 ZINCATO

 PORTATA

# STORAGE DOMINO

## SCAFFALI

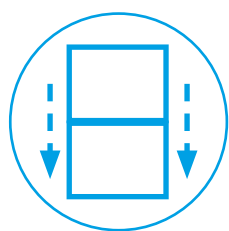

**Sovrapponibili**

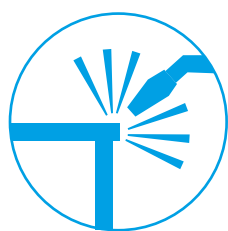

**Struttura saldata**



**Portata modulo fino a  
1600 kg**



**Fermo anticaduta**

# STORAGE DOMINO



ART.	L mm	P mm	H mm	RAL	€
FED30440101	1025	355	885	7000	322,50

Composto da:

qtà	descrizione
1	Scaffale a 16 posti per contenitori misura 3
16	Contenitore in polipropilene Picking Box misura 3

## Sovrapponibilità



n. telai sovrapposti	 di ogni telaio	 di ogni box
2	960	60
3	640	40



ART.	L mm	P mm	H mm	RAL	€
FED40540101	1765	500	885	7000	514,80

Composto da:

qtà	descrizione
1	Scaffale a 20 posti per contenitori misura 4
20	Contenitore in polipropilene Picking Box misura 4

## Sovrapponibilità

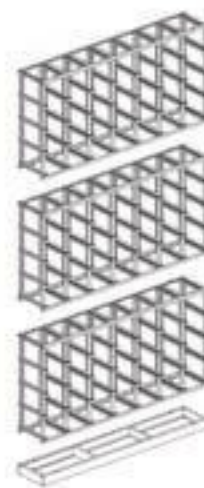

n. telai sovrapposti	 di ogni telaio	 di ogni box
3	1600	80

 RAL 7000

 PORTATA

# STORAGE DOMINO



ART.	L mm	P mm	H mm	RAL	€
FED30440201	1025	355	885	7000	502,50

Composto da:

qtà	descrizione
1	Scaffale a 16 posti per contenitori misura 3
16	Contenitore in metallo misura 3

## Sovrapponibilità



n. telai sovrapposti	 di ogni telaio	 di ogni box
2	960	60
3	640	40



ART.	L mm	P mm	H mm	RAL	€
FED40540201	1765	500	885	7000	778,20

Composto da:

qtà	descrizione
1	Scaffale a 20 posti per contenitori misura 4
20	Contenitore in metallo misura 4

## Sovrapponibilità

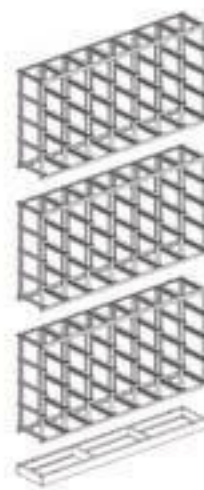

n. telai sovrapposti	 di ogni telaio	 di ogni box
3	1600	80



# STORAGE DOMINO

# COMPONENTI



Scaffale vuoto

ART.	L mm	P mm	H mm	RAL	€
FED30440A01	1025	310	885	7000	257,40



Scaffale vuoto

ART.	L mm	P mm	H mm	RAL	€
FED40540A01	1765	460	885	7000	321,60



Coperchio parapolvere

ART.	L mm	P mm	H mm	RAL	€
FED90340001	1020	315	20	7000	26,10



Coperchio parapolvere

ART.	L mm	P mm	H mm	RAL	€
FED90450001	1765	465	20	7000	37,20



Zoccolo di appoggio

ART.	L mm	P mm	H mm	RAL	€
FED92340001	1020	313	85	7000	49,50



Zoccolo di appoggio

ART.	L mm	P mm	H mm	RAL	€
FED92450001	1765	463	85	7000	72,60

 RAL 7000

 PORTATA

# STEEL

## CASSETTE, CONTENITORI E CONTAINERS IN METALLO

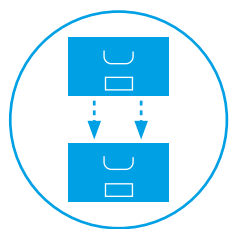

**Impilabili**

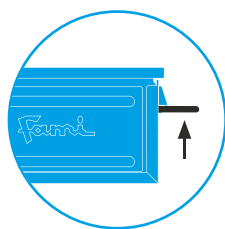

**Maniglia blocco a 90°**

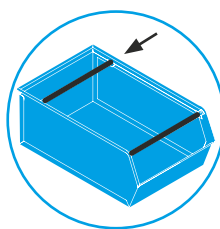

**Traversino di sollevamento**

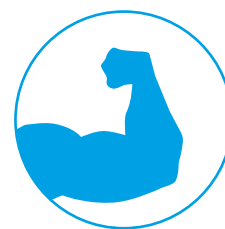

**Robusti**





272-3A2



272-3



272-4



272-4A5



272-5

ART.	multiplo d'ordine	mis.	dim. ingombro			dim. utili			L	RAL	€
			L mm	P mm	H mm	L mm	P mm	H mm			
FLA33200A01	10	272-3A2	325	210	145	300	200	130	8,7	7000	22,20
FLA41200A01	8	272-3	325	210	200	300	200	185	12	7000	23,40
FLA65200A01	6	272-4	480	315	200	450	300	185	27	7000	26,40
FLA73200A01	4	272-4A5	480	315	300	450	300	280	40,5	7000	43,20
FLA89200A01	6	272-5	660	480	300	630	450	280	85	7000	65,40





1



2



3A2



3

ART.	multiplo d'ordine	mis.	dim. ingombro			dim. utili			L	RAL	€
			L mm	P mm	H mm	L mm	P mm	H mm			
FLS17000A01	20	1	105	165	75	95	140	65	1	7000	4,50
FLS25000A01	20	2	150	235	125	140	195	115	3,8	7000	9,00
FLS33000A01	10	3A2	210	350	145	195	300	135	9,4	7000	18,60
FLS41000A01	8	3	210	350	200	200	300	185	12,5	7000	18,90



3P4



4A2



4



4A5

ART.	multiplo d'ordine	mis.	dim. ingombro			dim. utili			L	RAL	€
			L mm	P mm	H mm	L mm	P mm	H mm			
FLS49000A01	9	3P4	210	550	200	200	450	185	18	7000	26,40
FLS57000A01	8	4A2	310	500	145	300	450	135	20	7000	28,80
FLS65000A01	6	4	310	510	200	300	450	185	28	7000	24,60
FLS73000A01	4	4A5	310	525	315	300	450	280	42	7000	39,30

TRAVERSINO DI SOLLEVAMENTO ABBINATO ALLA MANIGLIA BLOCCO A 90°





5P4



5



5P4



5

ART.	multiplo d'ordine	mis.	dim. ingombro			dim. utili			n. slitte	L	RAL	€
			L mm	P mm	H mm	L mm	P mm	H mm				
FLS81000A01	6	5P4	480	540	300	450	450	280	-	63	7000	52,80
FLS89000A01	6	5	480	725	295	450	630	280	-	88	7000	55,20
FLS81100A01	4	5P4	480	540	385	450	450	280	2	63	7000	78,60
FLS89100A01	4	5	480	725	385	450	630	280	2	88	7000	79,80



4



4A5



5P4



5

ART.	multiplo d'ordine	mis.	dim. ingombro			dim. utili			L	RAL	€
			L mm	P mm	H mm	L mm	P mm	H mm			
FLS65010A01	6	4	310	510	200	300	450	185	28	7000	32,70
FLS73010A01	4	4A5	310	525	315	300	450	280	42	7000	48,60
FLS81010A01	6	5P4	480	540	300	450	450	280	63	7000	64,80
FLS89010A01	6	5	480	725	295	450	630	280	88	7000	67,20

## Applicazioni Speciali

CONTENITORI CON DOPPIO TRAVERSINO



sistema di prelevamento con carrello elevatore

CONTENITORI CON SLITTA



sistema di prelevamento con carrello elevatore



**Container con fondo apribile a rulli**

ART.	L mm	P mm	H mm	KG	RAL	€
FML01210001	1095	865	1265	2000	7000	762,90

**Container con fondo apribile a rulli**

ART.	L mm	P mm	H mm	KG	RAL	€
FML01110001	1095	865	915	2000	7000	660,60

**CONTAINERS CON FONDO APRIBILE A RULLI**

Sollevati con carrello elevatore tramite le quattro maniglie saldate al bordo superiore, consentono di scaricare il materiale per mezzo del fondo apribile a rulli (apertura dell'87%). L'apertura avviene in modo facile e sicuro tramite la leva posta sul lato da 800 mm, mentre la chiusura mediante un particolare dispositivo composto di leve e rulli d'acciaio.





**Container a bocca di lupo**

ART.	multiplo d'ordine	L mm	P mm	H mm	 KG	RAL	€
FML05100A01	3	830	680	600	1000	7000	167,10



RAL 7000



PORTATA



# EURO BOX

## NESTABLE BOX LIGHT

## PICKING BOX-VISUAL BOX

### CASSETTE E CONTENITORI IN PLASTICA



**Polipropilene**



**Ecogreen**



**ABS**



**Polistirolo**



**Polietilene**





## 300 x 200 mm

ART.	dim. ingombro			dim. utili			L	colore	€
	L mm	P mm	H mm	L mm	P mm	H mm			
FAXEB3212A05101	298	200	120	259	160	116	5	Grigio scuro	6,30
FAXEB3217A05101	298	198	170	259	160	166	7	Grigio scuro	6,90
FAXEB32HG005101	298	192	15	-	-	-	-	Grigio scuro	3,60



## 400 x 300 mm

ART.	dim. ingombro			dim. utili			L	colore	€
	L mm	P mm	H mm	L mm	P mm	H mm			
FAXEB4312A05101	400	300	120	355	255	116	10	Grigio scuro	8,70
FAXEB4317A05101	400	300	170	355	255	166	15	Grigio scuro	11,10
FAXEB4322A05101	400	300	220	355	255	216	20	Grigio scuro	12,00
FAXEB4332A05101	400	300	325	355	255	321	30	Grigio scuro	17,40
FAXEB43HG005101	400	300	-	-	-	-	-	Grigio scuro	4,80



## 600 x 400 mm

ART.	dim. ingombro			dim. utili			L	colore	€
	L mm	P mm	H mm	L mm	P mm	H mm			
FAXEB6412A05101	600	400	120	555	355	116	20	Grigio scuro	14,40
FAXEB6417A05101	600	400	170	555	355	166	30	Grigio scuro	17,70
FAXEB6422A05101	600	400	220	555	355	216	40	Grigio scuro	22,80
FAXEB6428A05101	600	400	280	555	355	276	53	Grigio scuro	26,70



## 600 x 400 mm

ART.	dim. ingombro			dim. utili			L	colore	€
	L mm	P mm	H mm	L mm	P mm	H mm			
FAXEB6432A05101	600	400	325	555	355	321	60	Grigio scuro	29,70
FAXEB6443B05101	600	400	430	555	355	426	90	Grigio scuro	38,10
FAXEB64HG005101	600	400	-	-	-	-	-	Grigio scuro	9,60



### Carrello per cassette Euro Box con base in acciaio con ruote

ART.	L mm	P mm	H mm	KG	ruote			materiale	finitura	€
					🔧	🔧	Ø			
FCP20110299	698	415	870	150	1	3	100	Gomma standard	Zincato	102,00



### Carrello per cassette Euro Box con base in acciaio con ruote

ART.	L mm	P mm	H mm	KG	ruote			materiale	finitura	€
					🔧	🔧	Ø			
FCP20110199	615	415	165	150	1	3	100	Gomma standard	Zincato	66,00



## 800 x 600 mm

ART.	dim. ingombro			dim. utili			L	colore	€
	L mm	P mm	H mm	L mm	P mm	H mm			
FAXEB8612C05101	800	600	120	755	555	101	49	Grigio scuro	36,90
FAXEB8617C05101	800	600	170	755	555	151	69	Grigio scuro	39,60
FAXEB8622C05101	800	600	220	755	555	201	90	Grigio scuro	40,80



## 800 x 600 mm

ART.	dim. ingombro			dim. utili			L	colore	€
	L mm	P mm	H mm	L mm	P mm	H mm			
FAXEB8632C05101	800	600	325	755	555	306	130	Grigio scuro	46,50
FAXEB8643C05101	800	600	430	755	555	411	175	Grigio scuro	53,70
FAXEB86SE005101	800	600	-	-	-	-	-	Grigio scuro	15,30



### Kit ruote

ART.	Ø mm	KG	KG	H mm	materiale	🔄	🛑	€
FKRD1002107	100	75	225	128	Gomma standard	2	2	44,10



### Kit viti per fissaggio ruote su cassetta Euro Box

ART.	pz. per confezione	€
FVT01380000	16	3,00



RUOTA GIREVOLE



RUOTA GIREVOLE CON FRENO



RUOTA FISSA



ZINCATO



PORTATA



CAPACITÀ



### 400 x 300 mm

ART.	dim. ingombro			dim. utili			L	colore	€
	L mm	P mm	H mm	L mm	P mm	H mm			
FAXEB4312A05401	400	300	120	355	255	116	10	Grigio scuro	7,20
FAXEB4317A05401	400	300	170	355	255	166	15	Grigio scuro	9,30
FAXEB4322A05401	400	300	220	355	255	216	20	Grigio scuro	10,20
FAXEB4332A05401	400	300	325	355	255	321	30	Grigio scuro	14,10
FAXEB43HG005401	400	300	-	-	-	-	-	Grigio scuro	3,90



### 600 x 400 mm

ART.	dim. ingombro			dim. utili			L	colore	€
	L mm	P mm	H mm	L mm	P mm	H mm			
FAXEB6412A05401	600	400	120	555	355	116	20	Grigio scuro	12,30
FAXEB6417A05401	600	400	170	555	355	166	30	Grigio scuro	14,70
FAXEB6422A05401	600	400	220	555	355	216	40	Grigio scuro	18,30
FAXEB6432A05401	600	400	325	555	355	321	60	Grigio scuro	23,70
FAXEB64HG005401	600	400	-	-	-	-	-	Grigio scuro	7,80

## NESTABLE BOX LIGHT POLIPROPILENE



600 x 400 mm

ART.	dim. ingombro			dim. utili			L	colore	€
	L mm	P mm	H mm	L mm	P mm	H mm			
FAXNL6420B05101	600	400	200	453	336	197	32	Grigio scuro	15,00
FAXNL6430B05101	600	400	300	453	336	297	50	Grigio scuro	22,50
FAXNL6440B05101	600	400	400	453	336	397	70	Grigio scuro	28,80
FAXNL64SE005101	600	400	-	-	-	-	-	Grigio scuro	10,50

## PICKING BOX

## ECOGREEN



ART.	multiplo d'ordine	mis.	dim. ingombro			dim. utili			L	colore	€
			L mm	P mm	H mm	L mm	P mm	H mm			
FAXPBC001A05401	50	1	100	170	75	88	133	65	1	Grigio scuro	1,20
FAXPBC002A05401	54	2	150	230	125	127	191	110	3,8	Grigio scuro	2,10
FAXPBC3A2B05401	21	3A2	210	350	145	180	270	130	9,4	Grigio scuro	5,10
FAXPBC003B05401	15	3	210	350	200	180	270	183	12,5	Grigio scuro	6,00
FAXPBC004B05401	10	4	310	500	200	282	425	183	28	Grigio scuro	11,70



1



2



3A2



3



4A2

ART.	multiplo d'ordine	mis.	dim.ingombro			dim. utili			L	colore	€
			L mm	P mm	H mm	L mm	P mm	H mm			
FAXPBC001A05101	50	1	100	170	75	88	133	65	1	Grigio scuro	1,50
FAXPBC001A05102	50	1	100	170	75	88	133	65	1	Verde	1,50
FAXPBC001A05103	50	1	100	170	75	88	133	65	1	Rosso	1,50
FAXPBC001A05104	50	1	100	170	75	88	133	65	1	Blu	1,50
FAXPBC001A05105	50	1	100	170	75	88	133	65	1	Giallo	1,50
FAXPBC002A05101	54	2	150	230	125	127	191	110	3,8	Grigio scuro	2,40
FAXPBC002A05102	54	2	150	230	125	127	191	110	3,8	Verde	2,40
FAXPBC002A05103	54	2	150	230	125	127	191	110	3,8	Rosso	2,40
FAXPBC002A05104	54	2	150	230	125	127	191	110	3,8	Blu	2,40
FAXPBC002A05105	54	2	150	230	125	127	191	110	3,8	Giallo	2,40
FAXPBC3A2B05101	21	3A2	210	350	145	180	270	130	9,4	Grigio scuro	6,00
FAXPBC3A2B05102	21	3A2	210	350	145	180	270	130	9,4	Verde	6,00
FAXPBC3A2B05103	21	3A2	210	350	145	180	270	130	9,4	Rosso	6,00
FAXPBC3A2B05104	21	3A2	210	350	145	180	270	130	9,4	Blu	6,00
FAXPBC3A2B05105	21	3A2	210	350	145	180	270	130	9,4	Giallo	6,00
FAXPBC003B05101	15	3	210	350	200	180	270	183	12,5	Grigio scuro	6,90
FAXPBC003B05102	15	3	210	350	200	180	270	183	12,5	Verde	6,90
FAXPBC003B05103	15	3	210	350	200	180	270	183	12,5	Rosso	6,90
FAXPBC003B05104	15	3	210	350	200	180	270	183	12,5	Blu	6,90
FAXPBC003B05105	15	3	210	350	200	180	270	183	12,5	Giallo	6,90
FAXPBC4A2B05101	14	4A2	310	500	145	282	425	134	20	Grigio scuro	12,00
FAXPBC4A2B05102	14	4A2	310	500	145	282	425	134	20	Verde	12,00
FAXPBC4A2B05103	14	4A2	310	500	145	282	425	134	20	Rosso	12,00
FAXPBC4A2B05104	14	4A2	310	500	145	282	425	134	20	Blu	12,00
FAXPBC4A2B05105	14	4A2	310	500	145	282	425	134	20	Giallo	12,00





4



4A5



5P4



5

ART.	multiplo d'ordine	mis.	dim.ingombro			dim. utili			L	colore	€
			L mm	P mm	H mm	L mm	P mm	H mm			
FAXPBC004B05101	10	4	310	500	200	282	425	183	28	Grigio scuro	13,50
FAXPBC004B05102	10	4	310	500	200	282	425	183	28	Verde	13,50
FAXPBC004B05103	10	4	310	500	200	282	425	183	28	Rosso	13,50
FAXPBC004B05104	10	4	310	500	200	282	425	183	28	Blu	13,50
FAXPBC004B05105	10	4	310	500	200	282	425	183	28	Giallo	13,50
FAXPBC4A5B05101	6	4A5	310	500	300	282	425	285	42	Grigio scuro	16,50
FAXPBC4A5B05102	6	4A5	310	500	300	282	425	285	42	Verde	16,50
FAXPBC4A5B05103	6	4A5	310	500	300	282	425	285	42	Rosso	16,50
FAXPBC4A5B05104	6	4A5	310	500	300	282	425	285	42	Blu	16,50
FAXPBC4A5B05105	6	4A5	310	500	300	282	425	285	42	Giallo	16,50
FAXPBZ5P4E05101	1	5P4	472	535	300	432	435	281	63	Grigio scuro	30,90
FAXPBZ5P4E05102	1	5P4	472	535	300	432	435	281	63	Verde	30,90
FAXPBZ5P4E05103	1	5P4	472	535	300	432	435	281	63	Rosso	30,90
FAXPBZ5P4E05104	1	5P4	472	535	300	432	435	281	63	Blu	30,90
FAXPBZ5P4E05105	1	5P4	472	535	300	432	435	281	63	Giallo	30,90
FAXPBZ005E05101	1	5	472	720	300	434	615	275	88	Grigio scuro	39,00
FAXPBZ005E05102	1	5	472	720	300	434	615	275	88	Verde	39,00
FAXPBZ005E05103	1	5	472	720	300	434	615	275	88	Rosso	39,00
FAXPBZ005E05104	1	5	472	720	300	434	615	275	88	Blu	39,00
FAXPBZ005E05105	1	5	472	720	300	434	615	275	88	Giallo	39,00



### Divisorio longitudinale in plastica

ART.	multiplo d'ordine	per contenitore mis.	L mm	H mm	colore	€
FAXPBDC3A207107	10	3A2	300	105	Nero	2,40
FAXPBDC00307107	10	3	305	160	Nero	3,00
FAXPBDC00407107	10	4	460	160	Nero	4,20



ART.	multiplo d'ordine	dim. ingombro			cassetti				colore	€
		Lmm	Pmm	Hmm	n.	Lmm	Pmm	Hmm		
FAXVBCH00900001	2	600	69	77	9	59	44	49	Grigio scuro	16,80
FAXVBCH00600001	2	600	98	112	6	87	66	72	Grigio scuro	20,40
FAXVBCH00500001	1	600	141	164	5	113	100	110	Grigio scuro	32,40
FAXVBCH00400001	1	600	174	206	4	142	130	135	Grigio scuro	42,30
FAXVBCH00300001	1	600	209	240	3	190	146	164	Grigio scuro	47,70
FAXVBCH00200001	1	600	311	353	2	285	219	246	Grigio scuro	92,70

### Fermo per cassettera Visual Box

ART.	adatto per	€
FAXVBCHL0900099	FAXVBCH0090000	1,80
FAXVBCHL0600099	FAXVBCH0060000	1,80
FAXVBCHL0500099	FAXVBCH0050000	1,80
FAXVBCHL0400099	FAXVBCH0040000	1,80
FAXVBCHL0300099	FAXVBCH0030000	1,80
FAXVBCHL0200099	FAXVBCH0020000	1,80



### Scaffale vuoto da parete per cassettera Visual Box

ART.	Lmm	Pmm	Hmm	RAL	€
FVBSW1500000001	604	41	1502	7000	36,00
FVBSW1950000001	604	41	1952	7000	39,30



### Base per scaffale Visual Box

ART.	Lmm	Pmm	Hmm	RAL	€
FVBSBASE0000001	600	300	100	7000	35,70





**Tappeto antisdrucchiolo in polietilene**

ART.	Lmm	Pmm	Hmm	colore	€
FAXSMTC08004001	800	400	25	Grigio scuro	19,80
FAXSMTC08004006	800	400	25	Rosso mattone	19,80

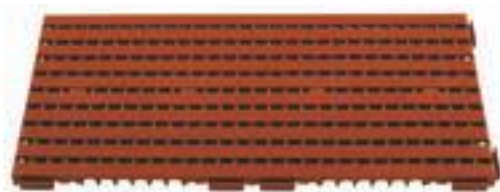

**Tappeto antisdrucchiolo forato in polietilene**

ART.	Lmm	Pmm	Hmm	colore	€
FAXSMTA08004001	800	400	25	Grigio scuro	18,30
FAXSMTA08004006	800	400	25	Rosso mattone	18,30



**Raccordo per tappeto in polietilene**

ART.	Lmm	Pmm	Hmm	colore	€
FAXSMRC04001205	400	120	25	Giallo	4,20



**Angolo per tappeto in polietilene**

ART.	Lmm	Pmm	Hmm	colore	€
FAXSMAN01201205	120	120	25	Giallo	2,40



**Clip per aggancio tappeto**

ART.	Pmm	Hmm	finitura	€
FAXSMCL00000099	10	14	Zincato	0,30



ZINCATO

RAL 7000

**7** *GEAR*  
*GARAGE*









## Caratteristiche

### Tutto parte dal piano

I moduli inferiori dispongono di un piano di lavoro di profondità 630 mm che consente di disporre di spazi ampi per poter lavorare in comodità.

### Lo scorrere dell'anta

Gli armadi ad ante scorrevoli aumentano la capacità di stoccaggio della postazione di lavoro riducendo gli ingombri e gli ostacoli che deriverebbero dall'utilizzo di armadi ad ante a battente.







### L'armadio segreto

L'armadio tecnico è ideato per celare all'interno rotoli per arrotolatori e cavi elettrici, così da rendere visibili solo i componenti necessari per il lavoro.



### Il basculante del Garage

Aperture basculanti possono essere inserite nei moduli inferiori per sfruttare spazi che altrimenti sarebbero inutilizzati. Facilitano la differenziazione dei rifiuti, contribuendo a mantenere la postazione di lavoro pulita e in ordine.



### Dietro l'angolo

Il modulo ad angolo può essere arricchito con un massimo di 4 prese elettriche e 2 arrotolatori. Permette di sfruttare al massimo gli spazi e di disporre di un piano di lavoro di notevoli dimensioni.





## Il cassetto delle meraviglie

Estrazione del 100% e portata di 70 kg rendono i cassetti la custodia ideale per attrezzatura e utensili per il lavoro. L'estrazione totale permette di avere una visuale completa dell'interno e facilita il prelievo del materiale stoccato.



## Autoportante

Tutte le soluzioni che compongono Gear Garage non necessitano di fissaggio a muro. Le diverse strutture come moduli e pensili sono autoportanti.



## Stoccaggio sospeso

Il pensile con apertura a Vasistas silenziosa può essere installato a muro oppure su parete forata e permette di avere a disposizione un ulteriore luogo per l'organizzazione del materiale di lavoro.



## Moduli

Il sistema modulare di Gear Garage permette l'integrazione di più moduli per creare strutture che possono adattarsi facilmente alle dimensioni dell'ambiente in cui devono essere installate. I moduli sono disponibili in 7 diverse larghezze, da un minimo di 512 mm ad un massimo di 2040 mm, e si suddividono in moduli base, piani di lavoro, pensili, armadi, cassettiere e angolari.



## Top in varie tipologie



Acciaio **inox** satinato



Acciaio **gommato**



Legno **multiplex**

## Garanzia



I 10 anni di garanzia dei prodotti Fami sono la diretta espressione dell'utilizzo di materiali di qualità, della cura e dedizione nella produzione per rendere i nostri arredi affidabili e durevoli nel tempo.



Courtesy of Trident Motorsport

## Tutti i colori più uno!

In base all'ambiente in cui è installato o in base ai colori aziendali, Gear Garage può essere monocolore o bicolore. Sono a disposizione, infatti, fino a 12 colori RAL per personalizzare la struttura e i frontali.

### Struttura

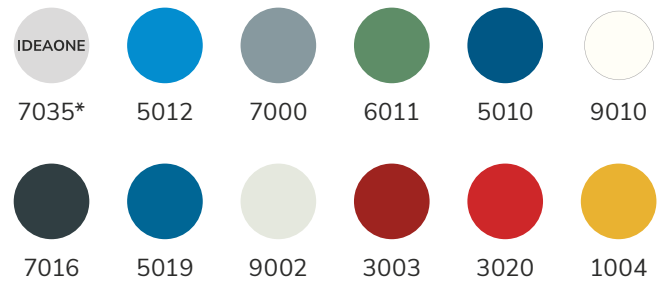

### Frontali

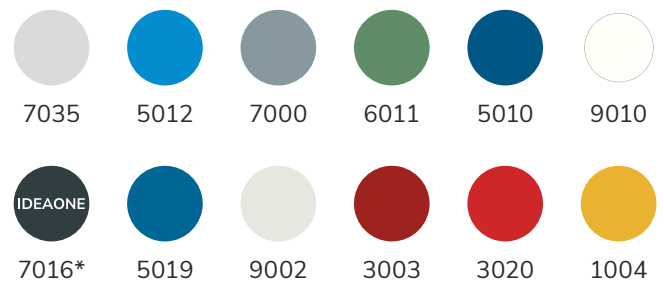

\*La struttura e i frontali nei colori **Ideaone** RAL 7035 + RAL 7016 sono pronti a magazzino.









ART.	L mm	P mm	H mm	Top	RAL	€
<b>GARAGE086</b>	3297	2684	2000	Inox satinato	7035+7016	7437,60
<b>GARAGE087</b>	3297	2684	2000	Acciaio gommato	7035+7016	7357,20

Composto da:

qtà	descrizione
2	Armadio con porta a battente
4	Kit 2 piani fessurati
2	Coppia tamponi per armadio
2	Armadio con 6 cassette 1x75 2x100 2x150 1x200
1	Armadio con 5 cassette 2x75 1x100 1x150 1x200
1	Maniglia a tubo
1	Kit ruote in gomma antitraccia sintetica Ø 125 mm
1	Kit tamponamento per armadio con ruote
1	Armadio con vano rifiuti con porta a battente
1	Porta rotolo con carta
1	Portello per rifiuti
1	Gamba ad angolo
1	Multipresa schuko a 4 scomparti
1	Cavo di collegamento wieland schuko/francese

qtà	descrizione
1	Armadio con porta a battente
1	Piano regolabile con supporti
5	Kit 4 piedini regolabili
1	Top in acciaio inox satinato L=2040 mm
1	Top in acciaio inox satinato per angolo L=714 mm
1	Top in acciaio inox satinato L=1428 mm
2	Kit viti di fissaggio
4	Coppia montanti
2	Montante centrale
2	Pannello forato/mensola con 1 bordo fermacasse
4	Pannello forato/mensola con 1 bordo fermacasse
2	Pensile vasistas senza serratura
1	Pensile vasistas ad angolo senza serratura
1	Pensile vasistas senza serratura



ART.	L mm	P mm	H mm	Top	RAL	€
<b>GARAGE088</b>	8976	630	2000	Inox satinato	7035+7016	10136,70
<b>GARAGE089</b>	8976	630	2000	Acciaio gommato	7035+7016	10039,50

Composto da:

qtà	descrizione
2	Armadio con porte scorrevoli
4	Kit 4 piani fessurati
2	Armadio con 6 cassetti 1x75 2x100 2x150 1x200
1	Armadio con 5 cassetti 2x75 1x100 1x150 1x200
1	Kit tamponamento per armadio con ruote
1	Maniglia a tubo
1	Kit ruote in gomma antitraccia sintetica Ø 125 mm
1	Gamba reversibile
1	Armadio con porte scorrevoli
2	Piano fessurato
1	Armadio con vano rifiuti con porta a battente
1	Portello per rifiuti
1	Porta rotolo con carta
9	Kit 4 piedini regolabili

qtà	descrizione
2	Top in acciaio inox satinato L=1428 mm
1	Top in acciaio inox satinato L=2040 mm
3	Kit viti di fissaggio
5	Coppia montanti
3	Montante centrale
4	Pannello forato/mensola con 1 bordo fermacasse
2	Pannello forato electric
2	Pannello forato/mensola con 1 bordo fermacasse
2	Multipresa schuko a 4 scomparti
2	Multipresa schuko a 2 scomparti
1	Cavo di collegamento wieland con spine in/out
1	Cavo di collegamento wieland schuko/francese
2	Pensile vasistas senza serratura
2	Pensile vasistas senza serratura





ART.	L mm	P mm	H mm	Top	RAL	€
<b>GARAGE090</b>	3063	630	2000	Inox satinato	7035+7016	4019,40
<b>GARAGE091</b>	3063	630	2000	Acciaio gommato	7035+7016	3987,00

Composto da:

qtà	descrizione	qtà	descrizione
1	Armadio con porte a battente	1	Porta rotolo con carta
1	Kit 4 piani fessurati	1	Portello per rifiuti
1	Coppia tamponi per armadio	2	Kit 4 piedini regolabili
1	Armadio con 6 cassetti 1x75 2x100 2x150 1x200	1	Top in acciaio inox satinato L=2040 mm
1	Armadio con 5 cassetti 2x75 1x100 1x150 1x200	1	Kit viti di fissaggio
1	Maniglia a tubo	1	Coppia montanti
1	Kit ruote in gomma antitraccia sintetica Ø 125 mm	1	Montante centrale
1	Kit tamponamento per armadio con ruote	2	Pannello forato/mensola con 1 bordo fermacasse
1	Armadio con vano rifiuti con porta a battente	2	Pensile vasistas senza serratura



ART.	L mm	P mm	H mm	Top	RAL	€
<b>GARAGE092</b>	2142	630	2000	Inox satinato	7035+7016	3267,90
<b>GARAGE093</b>	2142	630	2000	Acciaio gommato	7035+7016	3191,40

Composto da:

qtà	descrizione
1	Armadio con vano rifiuti con porta a battente
1	Portello per rifiuti
1	Porta rotolo con carta
1	Armadio con 6 cassette 1x75 2x100 2x150 1x200
1	Armadio con porta a battente
1	Piano regolabile con supporti
3	Kit 4 piedini regolabili
1	Top in acciaio inox satinato L=714 mm
1	Top in acciaio inox satinato L=1428 mm
2	Kit viti di fissaggio
2	Coppia montanti
1	Montante centrale
3	Pannello forato/mensola con 1 bordo fermacasse
1	Pensile vasistas senza serratura
1	Pensile vasistas senza serratura



ART.	L mm	P mm	H mm	Top	RAL	€
<b>GARAGE094</b>	1940	630	2000	Inox satinato	7035+7016	2430,30
<b>GARAGE095</b>	1940	630	2000	Acciaio gommato	7035+7016	2371,50

Composto da:

qtà	descrizione
1	Armadio con porta a battente
2	Kit 2 piani fessurati
1	Coppia tamponi per armadio
1	Armadio con 6 cassette 1x75 2x100 2x150 1x200
1	Armadio con porta a battente
1	Piano regolabile con supporti
2	Kit 4 piedini regolabili
1	Top in acciaio inox satinato L=1428 mm
1	Kit viti di fissaggio
1	Coppia montanti
1	Montante centrale
2	Pannello forato/mensola con 1 bordo fermacasse
1	Pensile vasistas senza serratura



ART.	L mm	P mm	H mm	Top	RAL	€
<b>GARAGE104</b>	2757	630	2000	Inox satinato	7035+7016	3269,10
<b>GARAGE105</b>	2757	630	2000	Acciaio gommato	7035+7016	3223,80

Composto da:

qtà	descrizione
1	Armadio con porte a battente
1	Kit 4 piani fessurati
1	Coppia tamponi per armadio
1	Armadio con 6 cassetti 1x75 2x100 2x150 1x200
1	Armadio tecnico con porta a battente
1	Multipresa schuko a 4 scomparti
1	Cavo di collegamento wieland schuko/francese
2	Kit 4 piedini regolabili

qtà	descrizione
1	Top in acciaio inox satinato L=1734 mm
1	Kit viti di fissaggio
1	Coppia montanti
1	Montante centrale
1	Pannello forato/mensola con 1 bordo fermacasse
1	Pannello forato/mensola con 1 bordo fermacasse
1	Pensile vasistas senza serratura
1	Pensile vasistas senza serratura





ART.	L mm	P mm	H mm	Top	RAL	€
<b>GARAGE096</b>	1940	630	2000	Inox satinato	7035+7016	2567,10
<b>GARAGE097</b>	1940	630	2000	Acciaio gommato	7035+7016	2534,70

Composto da:

qtà	descrizione
1	Armadio con porta a battente
2	Kit 2 piani fessurati
1	Coppia tamponi per armadio
1	Armadio con 6 cassette 1x75 2x100 2x150 1x200
1	Armadio con vano rifiuti con porta a battente
1	Portello per rifiuti
1	Porta rotolo con carta
2	Kit 4 piedini regolabili
1	Top in acciaio inox satinato L=1428 mm
1	Kit viti di fissaggio
1	Coppia montanti
1	Montante centrale
2	Pannello forato/mensola con 1 bordo fermacasse
1	Pensile vasistas senza serratura



ART.	L mm	P mm	H mm	Top	RAL	€
<b>GARAGE098</b>	1428	630	2000	Inox satinato	7035+7016	2010,00
<b>GARAGE099</b>	1428	630	2000	Acciaio gommato	7035+7016	1977,60

Composto da:

qtà	descrizione
1	Armadio con 7 cassette 1x75 4x100 2x150
1	Armadio con 5 cassette 1x75 2x150 2x200
2	Kit 4 piedini regolabili
1	Top in acciaio inox satinato L=1428 mm
1	Kit viti di fissaggio
1	Montante centrale
1	Coppia montanti
2	Pannello forato/mensola con 1 bordo fermacasse
2	Pannello forato/mensola con 1 bordo fermacasse



ART.	L mm	P mm	H mm	Top	RAL	€
<b>GARAGE106</b>	5515	630	2000	Inox satinato	7035+7016	8069,40
<b>GARAGE107</b>	5515	630	2000	Acciaio gommato	7035+7016	7978,80

Composto da:

qtà	descrizione	qtà	descrizione
2	Armadio con porta a battente fessurata	2	Top in acciaio inox satinato L=1734 mm
4	Kit 2 vasche stagne interne di raccolta liquidi capacità 9 L	2	Kit viti di fissaggio
3	Coppia tamponi per armadio	2	Coppia montanti
2	Armadio con 6 cassetti 1x75 2x100 2x150 1x200	2	Montante centrale
2	Armadio con 5 cassetti 2x75 1x100 1x150 1x200	2	Pannello forato electric
2	Kit tamponamento per armadio con ruote	2	Multipresa schuko a 4 scomparti
2	Maniglia a tubo	2	Multipresa schuko a 2 scomparti
2	Kit ruote in gomma antitraccia sintetica Ø 125 mm	2	Cavo di collegamento wieland schuko/francese
2	Gamba reversibile	2	Pannello forato/mensola con 1 bordo fermacasse
1	Armadio con porte a battente	2	Pannello forato/mensola con 1 bordo fermacasse
1	Kit 4 piani fessurati	2	Pensile vasistas senza serratura
2	Kit 4 piedini regolabili	2	Pensile vasistas senza serratura



ART.	L mm	P mm	H mm	Top	RAL	€
<b>GARAGE100</b>	2041	630	2000	Inox satinato	7035+7016	2303,40
<b>GARAGE101</b>	2041	630	2000	Acciaio gommato	7035+7016	2271,00

Composto da:

qtà	descrizione
1	Armadio con 7 cassetti 1x75 4x100 2x150
1	Armadio con 5 cassetti 1x75 2x150 2x200
2	Kit 4 piedini regolabili
3	Traverso
1	Multipresa schuko a 4 scomparti
1	Cavo di collegamento wieland schuko/francese
1	Top in acciaio inox satinato L=2040 mm
1	Kit viti di fissaggio
1	Montante centrale
1	Coppia montanti
2	Pannello forato/mensola con 1 bordo fermacasse
2	Pannello forato/mensola con 1 bordo fermacasse



ART.	L mm	P mm	H mm	Top	RAL	€
<b>GARAGE102</b>	2041	630	2000	Inox satinato	7035+7016	2580,90
<b>GARAGE103</b>	2041	630	2000	Acciaio gommato	7035+7016	2548,50

Composto da:

qtà	descrizione
1	Armadio con porta a battente
1	Armadio con 5 cassetti 2x75 1x100 1x150 1x200
1	Maniglia a tubo
1	Kit ruote in gomma antitraccia sintetica Ø 125 mm
1	Kit tamponamento per armadio con ruote
1	Armadio con 6 cassetti 1x75 2x100 2x150 1x200
2	Kit 4 piedini regolabili
1	Top in acciaio inox satinato L=2040 mm
1	Kit viti di fissaggio
1	Coppia montanti
1	Montante centrale
2	Pannello forato/mensola con 1 bordo fermacasse
2	Pannello forato/mensola con 1 bordo fermacasse



ART.	L mm	P mm	H mm	Top	RAL	€
<b>GARAGE110</b>	5712	630	2000	Inox satinato	7035+7016	7689,90
<b>GARAGE111</b>	5712	630	2000	Acciaio gommato	7035+7016	7560,30

Composto da:

qtà	descrizione
2	Armadio con porte scorrevoli
2	Piano fessurato
2	Armadio con 6 cassetti 1x75 2x100 2x150 1x200
1	Armadio con vano rifiuti con porta a battente
1	Portello per rifiuti
1	Porta rotolo con carta
1	Gamba reversibile
1	Multipresa schuko a 4 scomparti
1	Cavo di collegamento wieland schuko/francese
1	Armadio con 5 cassetti 2x75 1x100 1x150 1x200

qtà	descrizione
1	Kit tamponamento per armadio con ruote
1	Maniglia a tubo
1	Kit ruote in gomma antitraccia sintetica Ø 125 mm
5	Kit 4 piedini regolabili
4	Top in acciaio inox satinato L=1428 mm
4	Kit viti di fissaggio
4	Montante centrale
4	Coppia montanti
8	Pannello forato/mensola con 1 bordo fermacasse
4	Pensile vasistas senza serratura

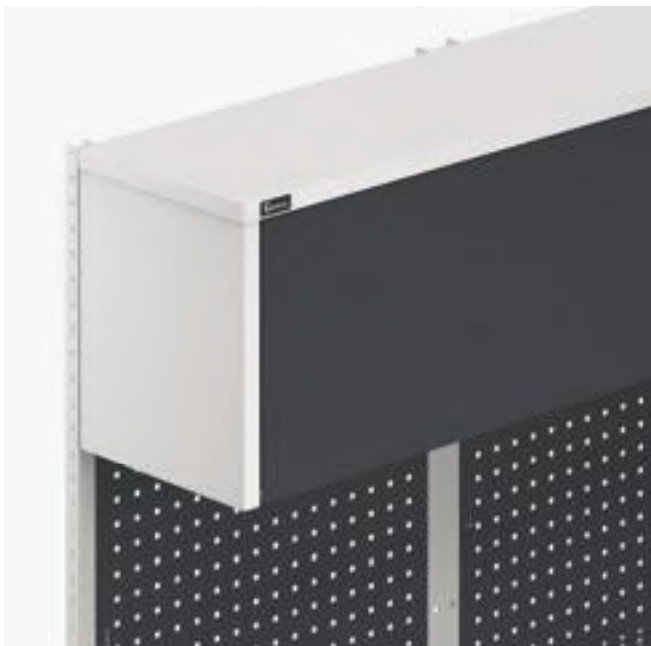



ART.	L mm	P mm	H mm	Top	RAL	€
<b>GARAGE108</b>	5508	630	2000	Inox satinato	7035+7016	7516,20
<b>GARAGE109</b>	5508	630	2000	Acciaio gommato	7035+7016	7425,60

Composto da:

qtà	descrizione	qtà	descrizione
2	Armadio con 6 cassetti 1x75 2x100 2x150 1x200	2	Top in acciaio inox satinato L=1734 mm
1	Armadio con 5 cassetti 2x75 1x100 1x150 1x200	2	Kit viti di fissaggio
1	Kit tamponamento per armadio con ruote	3	Coppia montanti
1	Maniglia a tubo	2	Montante centrale
1	Kit ruote in gomma antitraccia sintetica Ø 125 mm	2	Pannello forato electric
1	Gamba reversibile	2	Multipresa schuko a 4 scomparti
1	Armadio con porte scorrevoli	2	Multipresa schuko a 2 scomparti
2	Kit 4 piani fessurati	2	Cavo di collegamento wieland schuko/francese
1	Armadio con vano rifiuti con porta a battente	2	Pannello forato/mensola con 1 bordo fermacasse
1	Portello per rifiuti	2	Pannello forato/mensola con 1 bordo fermacasse
1	Porta rotolo con carta	2	Pensile vasistas senza serratura
5	Kit 4 piedini regolabili	2	Pensile vasistas senza serratura





ART.	L mm	P mm	H mm	Top	RAL	€
<b>GARAGE112</b>	744	744	2000	Inox satinato	7035+7016	1031,10
<b>GARAGE113</b>	744	744	2000	Acciaio gommato	7035+7016	1015,50

Composto da:

qtà	descrizione
1	Gamba ad angolo
1	Kit 4 piedini regolabili
1	Top in acciaio inox satinato per angolo L=714 mm
2	Coppia montanti
2	Pannello forato/mensola con 1 bordo fermacasse
1	Pensile vasistas ad angolo senza serratura



ART.	L mm	P mm	H mm	Top	RAL	€
<b>GARAGE114</b>	744	714	2000	Inox satinato	7035+7016	906,00
<b>GARAGE115</b>	744	714	2000	Acciaio gommato	7035+7016	890,40

Composto da:

qtà	descrizione
1	Gamba ad angolo
1	Kit 4 piedini regolabili
1	Top in acciaio inox satinato per angolo L=714 mm
1	Coppia montanti
1	Pannello forato/mensola con 1 bordo fermacasse
1	Pensile vasistas senza serratura



ART.	L mm	P mm	H mm	RAL	€
<b>GARAGE116</b>	583	600	921	7035+7016	726,60

Composto da:

qtà	descrizione
1	Armadio con 5 cassetti 2x75 1x100 1x150 1x200
1	Maniglia a tubo
1	Kit ruote in gomma antitraccia sintetica Ø 125 mm
1	Kit tamponamento per armadio con ruote



ART.	L mm	P mm	H mm	Top	RAL	€
<b>GARAGE001</b>	714	630	2000	Inox satinato	7035+7016	1422,00
<b>GARAGE002</b>	714	630	2000	Acciaio gommato	7035+7016	1377,90

Composto da:

qtà	descrizione
1	Armadio con 6 cassetti 1x75 2x100 2x150 1x200
1	Kit 4 piedini regolabili
1	Top in acciaio inox satinato L=714 mm
1	Kit viti di fissaggio
1	Coppia montanti
1	Pannello forato/mensola con 1 bordo fermacasse
1	Pensile vasistas senza serratura



ART.	L mm	P mm	H mm	Top	RAL	€
<b>GARAGE003</b>	714	630	2000	Inox satinato	7035+7016	1164,90
<b>GARAGE004</b>	714	630	2000	Acciaio gommato	7035+7016	1120,80

Composto da:

qtà	descrizione
1	Armadio con porta a battente
1	Piano regolabile con supporti
1	Kit 4 piedini regolabili
1	Top in acciaio inox satinato L=714 mm
1	Kit viti di fissaggio
1	Coppia montanti
1	Pannello forato/mensola con 1 bordo fermacasse
1	Pensile vasistas senza serratura



ART.	L mm	P mm	H mm	Top	RAL	€
<b>GARAGE005</b>	714	630	2000	Inox satinato	7035+7016	1245,60
<b>GARAGE006</b>	714	630	2000	Acciaio gommato	7035+7016	1201,50

Composto da:

qtà	descrizione
1	Armadio tecnico con porta a battente
1	Multipresa schuko a 4 scomparti
1	Cavo di collegamento wieland schuko/francese
1	Kit 4 piedini regolabili
1	Top in acciaio inox satinato L=714 mm
1	Kit viti di fissaggio
1	Coppia montanti
1	Pannello forato/mensola con 1 bordo fermacasse
1	Pensile vasistas senza serratura



ART.	L mm	P mm	H mm	RAL	€
<b>GARAGE007</b>	714	630	2000	7035+7016	1534,80

Composto da:

qtà	descrizione
1	Armadio con porta a battente
1	Kit 4 piedini regolabili
1	Top in acciaio inox satinato per lavello L=714 mm
1	Kit viti di fissaggio
1	Lavello
1	Miscelatore
1	Coppia montanti
1	Pannello forato/mensola con 1 bordo fermacasse
1	Pensile vasistas senza serratura



ART.	L mm	P mm	H mm	Top	RAL	€
<b>GARAGE008</b>	714	630	2000	Inox satinato	7035+7016	1346,40
<b>GARAGE009</b>	714	630	2000	Acciaio gommato	7035+7016	1302,30

Composto da:

qtà	descrizione
1	Armadio con vano rifiuti con porta a battente
2	Portello per rifiuti
1	Kit 4 piedini regolabili
1	Top in acciaio inox satinato L=714 mm
1	Kit viti di fissaggio
1	Coppia montanti
1	Pannello forato/mensola con 1 bordo fermacasse
1	Pensile vasistas senza serratura



ART.	L mm	P mm	H mm	Top	RAL	€
<b>GARAGE010</b>	714	630	2000	Inox satinato	7035+7016	1301,70
<b>GARAGE011</b>	714	630	2000	Acciaio gommato	7035+7016	1257,60

Composto da:

qtà	descrizione
1	Armadio con vano rifiuti con porta a battente
1	Portello per rifiuti
1	Porta rotolo con carta
1	Kit 4 piedini regolabili
1	Top in acciaio inox satinato L=714 mm
1	Kit viti di fissaggio
1	Coppia montanti
1	Pannello forato/mensola con 1 bordo fermacasse
1	Pensile vasistas senza serratura



ART.	L mm	P mm	H mm	Top	RAL	€
<b>GARAGE012</b>	1020	630	2000	Inox satinato	7035+7016	1609,80
<b>GARAGE013</b>	1020	630	2000	Acciaio gommato	7035+7016	1594,20

Composto da:

qtà	descrizione
1	Armadio con 6 cassetti 1x75 2x100 2x150 1x200
1	Kit 4 piedini regolabili
1	Top in acciaio inox satinato L=1020 mm
1	Kit viti di fissaggio
1	Coppia montanti
1	Pannello forato/mensola con 1 bordo fermacasse
1	Pensile vasistas senza serratura



ART.	L mm	P mm	H mm	Top	RAL	€
<b>GARAGE014</b>	1020	630	2000	Inox satinato	7035+7016	1555,80
<b>GARAGE015</b>	1020	630	2000	Acciaio gommato	7035+7016	1540,20

Composto da:

qtà	descrizione
1	Armadio con 5 cassetti 1x75 2x150 2x200
1	Kit 4 piedini regolabili
1	Top in acciaio inox satinato L=1020 mm
1	Kit viti di fissaggio
1	Coppia montanti
1	Pannello forato/mensola con 1 bordo fermacasse
1	Pensile vasistas senza serratura



ART.	L mm	P mm	H mm	Top	RAL	€
<b>GARAGE016</b>	1020	630	2000	Inox satinato	7035+7016	1298,10
<b>GARAGE017</b>	1020	630	2000	Acciaio gommato	7035+7016	1282,50

Composto da:

qtà	descrizione
1	Armadio con porte a battente
1	Piano regolabile con supporti
1	Kit 4 piedini regolabili
1	Top in acciaio inox satinato L=1020 mm
1	Kit viti di fissaggio
1	Coppia montanti
1	Pannello forato/mensola con 1 bordo fermacasse
1	Pensile vasistas senza serratura



ART.	L mm	P mm	H mm	Top	RAL	€
<b>GARAGE018</b>	1020	630	2000	Inox satinato	7035+7016	1387,50
<b>GARAGE019</b>	1020	630	2000	Acciaio gommato	7035+7016	1371,90

Composto da:

qtà	descrizione
1	Armadio con porte scorrevoli
1	Piano fessurato
1	Kit 4 piedini regolabili
1	Top in acciaio inox satinato L=1020 mm
1	Kit viti di fissaggio
1	Coppia montanti
1	Pannello forato/mensola con 1 bordo fermacasse
1	Pensile vasistas senza serratura



ART.	L mm	P mm	H mm	Top	RAL	€
<b>GARAGE020</b>	1020	630	2000	Inox satinato	7035+7016	1465,80
<b>GARAGE021</b>	1020	630	2000	Acciaio gommato	7035+7016	1450,20

Composto da:

qtà	descrizione
1	Armadio con porte scorrevoli fessurate
1	Kit 2 vasche stagne interne di raccolta liquidi capacità 19 L
1	Kit 4 piedini regolabili
1	Top in acciaio inox satinato L=1020 mm
1	Kit viti di fissaggio
1	Coppia montanti
1	Pannello forato/mensola con 1 bordo fermacasse
1	Pensile vasistas senza serratura



ART.	L mm	P mm	H mm	Top	RAL	€
<b>GARAGE022</b>	1020	630	2000	Inox satinato	7035+7016	1520,40
<b>GARAGE023</b>	1020	630	2000	Acciaio gommato	7035+7016	1504,80

Composto da:

qtà	descrizione
1	Armadio con porte scorrevoli fessurate in policarbonato
1	Piano fessurato
1	Kit 4 piedini regolabili
1	Top in acciaio inox satinato L=1020 mm
1	Kit viti di fissaggio
1	Coppia montanti
1	Pannello forato/mensola con 1 bordo fermacasse
1	Pensile vasistas senza serratura





ART.	L mm	P mm	H mm	Top	RAL	€
<b>GARAGE024</b>	1428	630	2000	Inox satinato	7035+7016	1966,20
<b>GARAGE025</b>	1428	630	2000	Acciaio gommato	7035+7016	1933,80

Composto da:

qtà	descrizione
1	Armadio con 6 cassetti 1x75 2x100 2x150 1x200
1	Armadio con porta a battente
1	Piano regolabile con supporti
2	Kit 4 piedini regolabili
1	Top in acciaio inox satinato L=1428 mm
1	Kit viti di fissaggio
1	Coppia montanti
1	Montante centrale
2	Pannello forato/mensola con 1 bordo fermacasse
1	Pensile vasistas senza serratura



ART.	L mm	P mm	H mm	Top	RAL	€
<b>GARAGE026</b>	1428	630	2000	Inox satinato	7035+7016	2381,40
<b>GARAGE027</b>	1428	630	2000	Acciaio gommato	7035+7016	2349,00

Composto da:

qtà	descrizione
1	Armadio con 6 cassetti 1x75 2x100 2x150 1x200
1	Kit 4 piedini regolabili
1	Armadio con 5 cassetti 2x75 1x100 1x150 1x200
1	Kit tamponamento per armadio con ruote
1	Maniglia a tubo
1	Kit ruote in gomma antitraccia sintetica Ø 125 mm
1	Gamba reversibile
1	Top in acciaio inox satinato L=1428 mm
1	Kit viti di fissaggio
1	Montante centrale
1	Coppia montanti
2	Pannello forato/mensola con 1 bordo fermacasse
1	Pensile vasistas senza serratura





ART.	L mm	P mm	H mm	Top	RAL	€
<b>GARAGE028</b>	1428	630	2000	Inox satinato	7035+7016	2103,00
<b>GARAGE029</b>	1428	630	2000	Acciaio gommato	7035+7016	2070,60

Composto da:

qtà	descrizione
1	Armadio con 6 cassette 1x75 2x100 2x150 1x200
1	Armadio con vano rifiuti con porta a battente
1	Portello per rifiuti
1	Porta rotolo con carta
2	Kit 4 piedini regolabili
1	Top in acciaio inox satinato L=1428 mm
1	Kit viti di fissaggio
1	Coppia montanti
1	Montante centrale
2	Pannello forato/mensola con 1 bordo fermacasse
1	Pensile vasistas senza serratura



ART.	L mm	P mm	H mm	Top	RAL	€
<b>GARAGE030</b>	1428	630	2000	Inox satinato	7035+7016	1581,00
<b>GARAGE031</b>	1428	630	2000	Acciaio gommato	7035+7016	1548,60

Composto da:

qtà	descrizione
1	Armadio con porte scorrevoli
1	Piano fessurato
1	Kit 4 piedini regolabili
1	Top in acciaio inox satinato L=1428 mm
1	Kit viti di fissaggio
1	Coppia montanti
1	Montante centrale
2	Pannello forato/mensola con 1 bordo fermacasse
1	Pensile vasistas senza serratura



ART.	L mm	P mm	H mm	Top	RAL	€
<b>GARAGE032</b>	1428	630	2000	Inox satinato	7035+7016	1708,50
<b>GARAGE033</b>	1428	630	2000	Acciaio gommato	7035+7016	1676,10

Composto da:

qtà	descrizione
1	Armadio con porte scorrevoli fessurate in policarbonato
1	Piano fessurato
1	Kit 4 piedini regolabili
1	Top in acciaio inox satinato L=1428 mm
1	Kit viti di fissaggio
1	Coppia montanti
1	Montante centrale
2	Pannello forato/mensola con 1 bordo fermacasse
1	Pensile vasistas senza serratura



ART.	L mm	P mm	H mm	Top	RAL	€
<b>GARAGE034</b>	1428	630	2000	Inox satinato	7035+7016	2046,90
<b>GARAGE035</b>	1428	630	2000	Acciaio gommato	7035+7016	2014,50

Composto da:

qtà	descrizione
1	Armadio con 6 cassetti 1x75 2x100 2x150 1x200
1	Armadio tecnico con porta a battente
1	Multipresa schuko a 4 scomparti
1	Cavo di collegamento wieland schuko/francese
2	Kit 4 piedini regolabili
1	Top in acciaio inox satinato L=1428 mm
1	Kit viti di fissaggio
1	Coppia montanti
1	Montante centrale
2	Pannello forato/mensola con 1 bordo fermacasse
1	Pensile vasistas senza serratura



ART.	L mm	P mm	H mm	Top	RAL	€
<b>GARAGE036</b>	1734	630	2000	Inox satinato	7035+7016	3052,80
<b>GARAGE037</b>	1734	630	2000	Acciaio gommato	7035+7016	3007,50

Composto da:

qtà	descrizione
1	Armadio con 6 cassetti 1x75 2x100 2x150 1x200
1	Kit 4 piedini regolabili
1	Armadio con 5 cassetti 2x75 1x100 1x150 1x200
1	Kit tamponamento per armadio con ruote
1	Maniglia a tubo
1	Kit ruote in gomma antitraccia sintetica Ø 125 mm
1	Gamba reversibile
1	Top in acciaio inox satinato L=1734 mm
1	Kit viti di fissaggio
1	Coppia montanti
1	Montante centrale
1	Pannello forato/mensola con 1 bordo fermacasse
1	Pannello forato/mensola con 1 bordo fermacasse
1	Pensile vasistas senza serratura
1	Pensile vasistas senza serratura



ART.	L mm	P mm	H mm	Top	RAL	€
<b>GARAGE038</b>	1734	630	2000	Inox satinato	7035+7016	3044,70

Composto da:

qtà	descrizione
1	Armadio con porte a battente
1	Piano regolabile con supporti
1	Armadio con vano rifiuti con porta a battente
2	Portello per rifiuti
2	Kit 4 piedini regolabili
1	Top in acciaio inox satinato L=1020 mm
1	Top in acciaio inox satinato per lavello L=714 mm
2	Kit viti di fissaggio
1	Lavello
1	Miscelatore
1	Coppia montanti
1	Montante centrale
1	Pannello forato/mensola con 1 bordo fermacasse
1	Pannello forato/mensola con 1 bordo fermacasse
1	Pensile vasistas senza serratura
1	Pensile vasistas senza serratura



ART.	L mm	P mm	H mm	Top	RAL	€
<b>GARAGE039</b>	1734	630	2000	Inox satinato	7035+7016	2774,40
<b>GARAGE040</b>	1734	630	2000	Acciaio gommato	7035+7016	2729,10

Composto da:

qtà	descrizione
1	Armadio con 6 cassetti 1x75 2x100 2x150 1x200
1	Armadio con vano rifiuti con porta a battente
1	Portello per rifiuti
1	Porta rotolo con carta
2	Kit 4 piedini regolabili
1	Top in acciaio inox satinato L=1734 mm
1	Kit viti di fissaggio
1	Coppia montanti
1	Montante centrale
1	Pannello forato/mensola con 1 bordo fermacasse
1	Pannello forato/mensola con 1 bordo fermacasse
1	Pensile vasistas senza serratura
1	Pensile vasistas senza serratura



ART.	L mm	P mm	H mm	Top	RAL	€
<b>GARAGE041</b>	1734	630	2000	Inox satinato	7035+7016	2672,40
<b>GARAGE042</b>	1734	630	2000	Acciaio gommato	7035+7016	2627,10

Composto da:

qtà	descrizione
1	Armadio con porte scorrevoli
1	Piano fessurato
1	Armadio con 6 cassetti 1x75 2x100 2x150 1x200
2	Kit 4 piedini regolabili
1	Top in acciaio inox satinato L=1734 mm
1	Kit viti di fissaggio
1	Coppia montanti
1	Montante centrale
1	Pannello forato/mensola con 1 bordo fermacasse
1	Pannello forato/mensola con 1 bordo fermacasse
1	Pensile vasistas senza serratura
1	Pensile vasistas senza serratura



ART.	L mm	P mm	H mm	Top	RAL	€
<b>GARAGE043</b>	1734	630	2000	Inox satinato	7035+7016	2805,30
<b>GARAGE044</b>	1734	630	2000	Acciaio gommato	7035+7016	2760,00

Composto da:

qtà	descrizione
1	Armadio con porte scorrevoli fessurate in policarbonato
1	Piano fessurato
1	Armadio con 6 cassette 1x75 2x100 2x150 1x200
2	Kit 4 piedini regolabili
1	Top in acciaio inox satinato L=1734 mm
1	Kit viti di fissaggio
1	Coppia montanti
1	Montante centrale
1	Pannello forato/mensola con 1 bordo fermacasse
1	Pannello forato/mensola con 1 bordo fermacasse
1	Pensile vasistas senza serratura
1	Pensile vasistas senza serratura



ART.	L mm	P mm	H mm	Top	RAL	€
<b>GARAGE045</b>	1734	630	2000	Inox satinato	7035+7016	2718,30
<b>GARAGE046</b>	1734	630	2000	Acciaio gommato	7035+7016	2673,00

Composto da:

qtà	descrizione
1	Armadio con 6 cassette 1x75 2x100 2x150 1x200
1	Armadio tecnico con porta a battente
1	Multipresa schuko a 4 scomparti
1	Cavo di collegamento wieland schuko/francese
2	Kit 4 piedini regolabili
1	Top in acciaio inox satinato L=1734 mm
1	Kit viti di fissaggio
1	Coppia montanti
1	Montante centrale
1	Pannello forato/mensola con 1 bordo fermacasse
1	Pannello forato/mensola con 1 bordo fermacasse
1	Pensile vasistas senza serratura
1	Pensile vasistas senza serratura



ART.	L mm	P mm	H mm	Top	RAL	€
<b>GARAGE047</b>	2040	630	2000	Inox satinato	7035+7016	2808,60
<b>GARAGE048</b>	2040	630	2000	Acciaio gommato	7035+7016	2776,20

Composto da:

qtà	descrizione
1	Armadio con 6 cassetti 1x75 2x100 2x150 1x200
1	Armadio con porte a battente
1	Piano regolabile con supporti
2	Kit 4 piedini regolabili
1	Top in acciaio inox satinato L=2040 mm
1	Kit viti di fissaggio
1	Coppia montanti
1	Montante centrale
2	Pannello forato/mensola con 1 bordo fermacasse
2	Pensile vasistas senza serratura



ART.	L mm	P mm	H mm	Top	RAL	€
<b>GARAGE049</b>	2040	630	2000	Inox satinato	7035+7016	3468,60
<b>GARAGE050</b>	2040	630	2000	Acciaio gommato	7035+7016	3436,20

Composto da:

qtà	descrizione
1	Armadio con 6 cassetti 1x75 2x100 2x150 1x200
1	Armadio con 5 cassetti 2x75 1x100 1x150 1x200
1	Maniglia a tubo
1	Kit ruote in gomma antitraccia sintetica Ø 125 mm
1	Kit tamponamento per armadio con ruote
1	Armadio con vano rifiuti con porta a battente
1	Porta rotolo con carta
1	Portello per rifiuti
2	Kit 4 piedini regolabili
1	Top in acciaio inox satinato L=2040 mm
1	Kit viti di fissaggio
1	Coppia montanti
1	Montante centrale
2	Pannello forato/mensola con 1 bordo fermacasse
2	Pensile vasistas senza serratura





ART.	L mm	P mm	H mm	Top	RAL	€
<b>GARAGE051</b>	2040	630	2000	Inox satinato	7035+7016	2898,00
<b>GARAGE052</b>	2040	630	2000	Acciaio gommato	7035+7016	2865,60

Composto da:

qtà	descrizione
1	Armadio con 6 cassette 1x75 2x100 2x150 1x200
1	Armadio con porte scorrevoli
1	Piano fessurato
2	Kit 4 piedini regolabili
1	Top in acciaio inox satinato L=2040 mm
1	Kit viti di fissaggio
1	Coppia montanti
1	Montante centrale
2	Pannello forato/mensola con 1 bordo fermacasse
2	Pensile vasistas senza serratura



ART.	L mm	P mm	H mm	Top	RAL	€
<b>GARAGE053</b>	2040	630	2000	Inox satinato	7035+7016	2466,60
<b>GARAGE054</b>	2040	630	2000	Acciaio gommato	7035+7016	2434,20

Composto da:

qtà	descrizione
1	Armadio con porte scorrevoli
2	Piano fessurato
2	Kit 4 piedini regolabili
1	Top in acciaio inox satinato L=2040 mm
1	Kit viti di fissaggio
1	Coppia montanti
1	Montante centrale
2	Pannello forato/mensola con 1 bordo fermacasse
2	Pensile vasistas senza serratura



ART.	L mm	P mm	H mm	Top	RAL	€
<b>GARAGE055</b>	2040	630	2000	Inox satinato	7035+7016	2643,60
<b>GARAGE056</b>	2040	630	2000	Acciaio gommato	7035+7016	2611,20

Composto da:

qtà	descrizione
1	Armadio con porte scorrevoli fessurate in policarbonato
2	Piano fessurato
2	Kit 4 piedini regolabili
1	Top in acciaio inox satinato L=2040 mm
1	Kit viti di fissaggio
1	Coppia montanti
1	Montante centrale
2	Pannello forato/mensola con 1 bordo fermacasse
2	Pensile vasistas senza serratura



ART.	L mm	P mm	H mm	Top	RAL	€
<b>GARAGE057</b>	2040	630	2000	Inox satinato	7035+7016	3217,80
<b>GARAGE058</b>	2040	630	2000	Acciaio gommato	7035+7016	3185,40

Composto da:

qtà	descrizione
1	Armadio con 6 cassetti 1x75 2x100 2x150 1x200
1	Armadio con porte scorrevoli fessurate in policarbonato
1	Kit 2 piani/pannelli forati
1	Canaletta elettrica per multiprese
1	Multipresa schuko a 2 scomparti
1	Multipresa schuko a 4 scomparti
1	Cavo di collegamento wieland schuko/francese
2	Kit 4 piedini regolabili
1	Top in acciaio inox satinato L=2040 mm
1	Kit viti di fissaggio
1	Coppia montanti
1	Montante centrale
2	Pannello forato/mensola con 1 bordo fermacasse
2	Pensile vasistas senza serratura



ART.	L mm	P mm	H mm	Top	RAL	€
<b>GARAGE059</b>	2040	630	2000	Inox satinato	7035+7016	1944,60
<b>GARAGE060</b>	2040	630	2000	Acciaio gommato	7035+7016	1912,20

Composto da:

qtà	descrizione
2	Gamba reversibile
3	Traverso
2	Multipresa schuko a 4 scomparti
2	Cavo di collegamento wieland schuko/francese
1	Top in acciaio inox satinato L=2040 mm
1	Kit viti di fissaggio
1	Coppia montanti
1	Montante centrale
2	Pannello forato/mensola con 1 bordo fermacasse
2	Pensile vasistas senza serratura



ART.	L mm	P mm	H mm	Top	RAL	€
<b>GARAGE061</b>	2040	630	2000	Inox satinato	7035+7016	2497,80
<b>GARAGE062</b>	2040	630	2000	Acciaio gommato	7035+7016	2465,40

Composto da:

qtà	descrizione
1	Gamba reversibile
3	Traverso
2	Multipresa schuko a 4 scomparti
2	Cavo di collegamento wieland schuko/francese
1	Armadio con 6 cassetti 1x75 2x100 2x150 1x200
1	Kit 4 piedini regolabili
1	Top in acciaio inox satinato L=2040 mm
1	Kit viti di fissaggio
1	Coppia montanti
1	Montante centrale
2	Pannello forato/mensola con 1 bordo fermacasse
2	Pensile vasistas senza serratura

ART.	L mm	P mm	H mm	Top	RAL	€
GARAGE063	2040	630	2000	Inox satinato	7035+7016	2991,30
GARAGE064	2040	630	2000	Acciaio gommato	7035+7016	2958,90

Composto da:

qtà	descrizione
2	Armadio con 6 cassetti 1x75 2x100 2x150 1x200
2	Kit 4 piedini regolabili
3	Traverso
1	Multipresa schuko a 4 scomparti
1	Cavo di collegamento wieland schuko/francese
1	Top in acciaio inox satinato L=2040 mm
1	Kit viti di fissaggio
1	Coppia montanti
1	Montante centrale
2	Pannello forato/mensola con 1 bordo fermacasse
2	Pensile vasistas senza serratura



Courtesy of Trident Motorsport



Armadio con porte a battente



Coppia tamponi per armadio



ART.	L mm	P mm	H mm	RAL	€
<b>GARAGE065</b>	512	630	2000	7035+7016	464,10

Composto da:

qtà	descrizione
1	Armadio con porta a battente
2	Kit 2 piani fessurati
1	Coppia tamponi per armadio



ART.	L mm	P mm	H mm	RAL	€
<b>GARAGE066</b>	512	630	2000	7035+7016	609,30

Composto da:

qtà	descrizione
1	Armadio con porta a battente fessurata
2	Kit 2 vasche stagne interne di raccolta liquidi capacità 9 L
1	Coppia tamponi per armadio



vedi pag. 256



ART.	L mm	P mm	H mm	RAL	€
<b>GARAGE067</b>	512	630	2000	7035+7016	644,10

Composto da:

qtà	descrizione
1	Armadio con porta a battente
2	Kit 2 piani fessurati
3	Cassetto a estrazione semplice H=100 mm
1	Coppia tamponi per armadio



Coppia tamponi per armadio



ART.	L mm	P mm	H mm	RAL	€
<b>GARAGE068</b>	1023	630	2000	7035+7016	550,80

Composto da:

qtà	descrizione
1	Armadio con porte a battente
1	Kit 4 piani fessurati
1	Coppia tamponi per armadio



ART.	L mm	P mm	H mm	RAL	€
<b>GARAGE069</b>	1023	630	2000	7035+7016	764,10

Composto da:

qtà	descrizione
1	Armadio con porte a battente
1	Kit 4 piani fessurati
3	Cassetto a estrazione semplice H=100 mm
1	Coppia tamponi per armadio



ART.	L mm	P mm	H mm	RAL	€
<b>GARAGE070</b>	1023	630	2000	7035+7016	928,50

Composto da:

qtà	descrizione
1	Armadio con porte a battente
1	Kit 3 piani fessurati
1	Kit 2 piani fessurati con guide
1	Kit 3 piani fessurati con guide
5	Contenitore in polipropilene Picking Box misura 2
6	Contenitore in polipropilene Picking Box misura 4
20	Contenitore in polipropilene Picking Box misura 3A2
6	Contenitore in polipropilene Picking Box misura 4A2
1	Coppia tamponi per armadio





Armadio con porte a battente



Coppia tamponi per armadio



ART.	L mm	P mm	H mm	RAL	€
<b>GARAGE071</b>	1023	630	2000	7035+7016	902,10

Composto da:

qtà	descrizione
1	Armadio con porte a battente
3	Cassetto a estrazione semplice H=100 mm
2	Kit 2 piani/pannelli forati
1	Coppia tamponi per armadio



ART.	L mm	P mm	H mm	RAL	€
<b>GARAGE072</b>	1023	630	2000	7035+7016	676,50

Composto da:

qtà	descrizione
1	Armadio con porte a battente fessurate in policarbonato
1	Kit 4 piani fessurati
1	Coppia tamponi per armadio



ART.	L mm	P mm	H mm	RAL	€
<b>GARAGE073</b>	1023	630	2000	7035+7016	882,90

Composto da:

qtà	descrizione
1	Armadio con porte a battente fessurate
2	Kit 2 piani/pannelli forati
2	Canaletta elettrica per multiprese
2	Multipresa schuko a 2 scomparti
2	Multipresa schuko a 4 scomparti
1	Cavo di collegamento wieland con spine in/out
1	Cavo di collegamento wieland schuko/francese
1	Coppia tamponi per armadio



# GEAR GARAGE **PERFOM L= 1020**

Armadio con porte scorrevoli



Coppia montanti



ART.	L mm	P mm	H mm	RAL	€
<b>GARAGE074</b>	1020	630	2000	7035+7016	898,80

Composto da:

qtà	descrizione
1	Armadio con porte scorrevoli
1	Kit 4 piani fessurati
1	Kit 4 piedini regolabili
1	Coppia montanti



ART.	L mm	P mm	H mm	RAL	€
<b>GARAGE075</b>	1020	630	2000	7035+7016	898,80

Composto da:

qtà	descrizione
1	Armadio con porte scorrevoli fessurate
1	Kit 4 piani fessurati
1	Kit 4 piedini regolabili
1	Coppia montanti



ART.	L mm	P mm	H mm	RAL	€
<b>GARAGE076</b>	1020	630	2000	7035+7016	1086,30

Composto da:

qtà	descrizione
1	Armadio con porte scorrevoli fessurate in policarbonato
1	Kit 4 piani fessurati
1	Kit 4 piedini regolabili
1	Coppia montanti

# GEAR GARAGE **PERFORM L= 1427**

Armadio con porte scorrevoli



Coppia montanti



ART.	L mm	P mm	H mm	RAL	€
<b>GARAGE077</b>	1427	630	2000	7035+7016	1148,70

Composto da:

qtà	descrizione
1	Armadio con porte scorrevoli
2	Kit 2 piani fessurati
1	Kit 4 piedini regolabili
1	Coppia montanti



ART.	L mm	P mm	H mm	RAL	€
<b>GARAGE078</b>	1427	630	2000	7035+7016	1148,70

Composto da:

qtà	descrizione
1	Armadio con porte scorrevoli fessurate
2	Kit 2 piani fessurati
1	Kit 4 piedini regolabili
1	Coppia montanti



ART.	L mm	P mm	H mm	RAL	€
<b>GARAGE079</b>	1427	630	2000	7035+7016	1452,90

Composto da:

qtà	descrizione
1	Armadio con porte scorrevoli fessurate in policarbonato
2	Kit 2 piani fessurati
1	Kit 4 piedini regolabili
1	Coppia montanti



RAL 7035 + RAL 7016



Coppia montanti



ART.	L mm	P mm	H mm	RAL	€
<b>GARAGE080</b>	2040	630	2000	7035+7016	1494,60

Composto da:

qtà	descrizione
1	Armadio con porte scorrevoli
2	Kit 4 piani fessurati
2	Kit 4 piedini regolabili
1	Coppia montanti



ART.	L mm	P mm	H mm	RAL	€
<b>GARAGE081</b>	2040	630	2000	7035+7016	1607,40

Composto da:

qtà	descrizione
1	Armadio con porte scorrevoli fessurate
1	Kit 4 piani fessurati
2	Kit 2 vasche stagne interne di raccolta liquidi capacità 19 L
2	Kit 4 piedini regolabili
1	Coppia montanti



ART.	L mm	P mm	H mm	RAL	€
<b>GARAGE082</b>	2040	630	2000	7035+7016	1898,70

Composto da:

qtà	descrizione
1	Armadio con porte scorrevoli fessurate in policarbonato
2	Kit 4 piani fessurati
2	Kit 4 piedini regolabili
1	Coppia montanti



Armadio con porte scorrevoli



Coppia montanti



ART.	L mm	P mm	H mm	RAL	€
<b>GARAGE083</b>	2040	630	2000	7035+7016	1826,70

Composto da:

qtà	descrizione
1	Armadio con porte scorrevoli fessurate
2	Kit 2 piani/pannelli forati
2	Canaletta elettrica per multiprese
2	Multipresa schuko a 4 scomparti
2	Multipresa schuko a 2 scomparti
1	Cavo di collegamento wieland con spine in/out
1	Cavo di collegamento wieland schuko/francese
1	Kit 4 piani fessurati
2	Kit 4 piedini regolabili
1	Coppia montanti



ART.	L mm	P mm	H mm	RAL	€
<b>GARAGE084</b>	2040	630	2000	7035+7016	1591,50

Composto da:

qtà	descrizione
1	Armadio con porte scorrevoli fessurate
1	Piano/pannello forato
1	Kit 3 piani fessurati
1	Parete divisorio
1	Kit tubo appendiabiti
1	Kit 4 piani fessurati
2	Kit 4 piedini regolabili
1	Coppia montanti



ART.	L mm	P mm	H mm	RAL	€
<b>GARAGE085</b>	2040	630	2000	7035+7016	1770,60

Composto da:

qtà	descrizione
1	Armadio con porte scorrevoli
4	Kit 2 piani/pannelli forati
2	Kit 4 piedini regolabili
1	Coppia montanti









**Arrotolatore elettrico con presa Schuko**

ART.	L cavo m	tipo presa	Volt	Watt	€
MBR13S0V0V00100	20	Schuko	230	1600	517,50



**Arrotolatore per aria compressa**

ART.	L cavo m	Pressione max Mpa	Ø mm	€
MBR13S0V0V00200	14	1,5	10	237,60



**Rullo per arrotolatore**

ART.	€
MBR13S0V0V00339	28,20



**Piastra per arrotolatore**

Da fissare alla parte posteriore dell'armadio

ART.	€
MBR13S0V0V00499	20,10

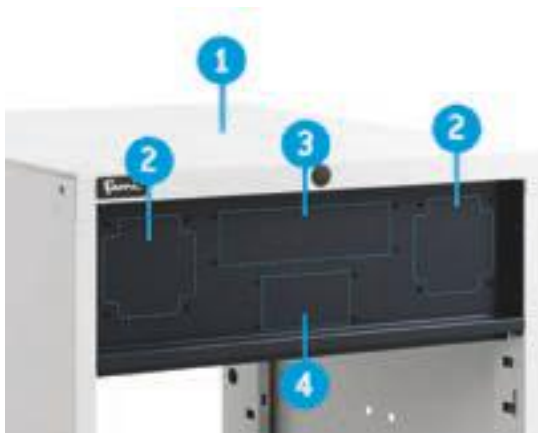

- 1. Armadio tecnico L=560 mm predisposto per porta
- 2. Modulo: Rullo per arrotolatore



- 3. Modulo: Multipresa a 4 scomparti
- 4. Modulo: Multipresa a 2 scomparti

L= 717 MM

36X27 EH



ART.	adatto per cassetto H mm	componenti	€
FFH10051000	50/300	3 x Divisorio a 3 canali 9 x Divisorio a 4 canali 12 x Divisorio trasversale L=47 mm 36 x Divisorio trasversale L=36 mm	30,00



ART.	adatto per cassetto H mm	componenti	€
FFH10051300	50/300	18 x Divisorio trasversale L=47 mm 12 x Divisorio trasversale L=73 mm 6 x Divisorio a 2 canali 6 x Divisorio a 3 canali	27,00



ART.	adatto per cassetto H mm	componenti	€
FFH10051500	50/300	20 x Divisorio trasversale L=36 mm 20 x Divisorio trasversale L=47 mm 6 x Divisorio a 3 canali 5 x Divisorio a 4 canali 1 x Porta chiavi a brugola	30,00



ART.	adatto per cassetto H mm	componenti	€
FFH10071800	75	16 x Cassetta divisorio 75x75 mm 8 x Cassetta divisorio 150x75 mm 4 x Cassetta divisorio 150x150 mm	30,60



ART.	adatto per cassetto H mm	componenti	€
FFH10071600	75	12 x Cassetta divisorio 150x75 mm	27,90
FFH10101600	100/125	6 x Cassetta divisorio 150x150 mm	32,70



ART.	adatto per cassetto H mm	componenti	€
FFH10070500	75		15,30
FFH10100500	100/125	2 x Divisorio longitudinale fessurato L=457 mm	15,90
FFH10150500	150/175	3 x Divisorio trasversale L=202 mm	21,30
FFH10200500	200/250		30,30



**L= 1023 MM 54X27 EH**



ART.	adatto per cassetto H mm	componenti	€
FFH40051200	50/300	15 x Divisorio trasversale L=36 mm 10 x Divisorio trasversale L=47 mm 6 x Divisorio trasversale L=73 mm 6 x Divisorio a 2 canali 6 x Divisorio a 3 canali 6 x Divisorio a 4 canali	37,20



ART.	adatto per cassetto H mm	componenti	€
FFH40051500	50/300	30 x Divisorio trasversale L=36 mm 10 x Divisorio trasversale L=47 mm 6 x Divisorio a 3 canali 12 x Divisorio a 4 canali	39,60



ART.	adatto per cassetto H mm	componenti	€
FFH40071100	75	18 x Cassetta divisorio 150x150 mm	39,90
FFH40101100	100/125		45,00



ART.	adatto per cassetto H mm	componenti	€
FFH40071300	75	12 x Cassetta divisorio 150x75 mm 12 x Cassetta divisorio 150x150 mm	41,70
FFH40101300	100/125		48,00



ART.	adatto per cassetto H mm	componenti	€
FFH40071600	75	20 x Cassetta divisorio 75x75 mm 14 x Cassetta divisorio 150x75 mm 6 x Cassetta divisorio 150x150 mm	45,90

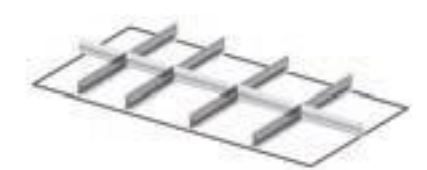

ART.	adatto per cassetto H mm	componenti	€
FFH40070500	75	4 x Divisorio longitudinale fessurato L=457 mm 2 x Divisorio trasversale L=151 mm 3 x Divisorio trasversale L=202 mm	22,80
FFH40100500	100/125		26,10
FFH40150500	150/175		38,10
FFH40200500	200/250		55,80

THE  
**BLOCK**

**UNIPOK**  
MIX AND MATCH







Fanni





Fanni





A series of horizontal lines for writing, starting with a pair of lines at the top and followed by single lines below.

# CONDIZIONI GENERALI DI GARANZIA

Gentile Cliente,

ogni acquisto di prodotti di Fami S.r.l. è accompagnato da una garanzia convenzionale (la "Garanzia"), disciplinata in conformità alle modalità ed ai termini qui di seguito indicati.

## 1. PREMESSE:

Nelle Condizioni che seguono, i termini sotto indicati avranno il seguente significato:

a) Venditore: Fami S.r.l.

b) Acquirente: qualunque soggetto (persona fisica, società, ente, entità giuridica) che acquisti i Prodotti del Venditore;

c) Prodotto/i: i beni fabbricati, assemblati e/o commercializzati dal Venditore, esclusi i Prodotti a marchio Store Van;

## 2. OGGETTO DELLA GARANZIA

2.1 Fami S.r.l. garantisce che i Prodotti sono esenti da vizi e conformi alle specifiche tecniche dichiarate dal Venditore.

2.2 Resta inteso che le dimensioni dei Prodotti sono da intendersi tenendo conto dei margini di tolleranza d'uso nel commercio con riferimento al tipo, quantità, qualità dei Prodotti. Il Venditore, pertanto, non garantisce la rispondenza dei Prodotti a particolari specifiche o caratteristiche tecniche o la loro idoneità ad usi particolari diversi rispetto a quelle indicate nelle specifiche tecniche dichiarate da Fami S.r.l. e previste nel manuale d'uso e manutenzione, se non nella misura in cui tali caratteristiche siano state espressamente convenute nel contratto di vendita.

2.3 Qualora venga segnalata dal Cliente ed accertata la presenza di difetti sui Prodotti, il Cliente avrà diritto alla loro riparazione gratuita ovvero, qualora la riparazione risulti impossibile o economicamente onerosa, alla sostituzione gratuita del Prodotto, ad insindacabile giudizio del Venditore, con esclusione di ogni ulteriore e diversa obbligazione in capo a Fami S.r.l..

2.4 La Garanzia non pregiudica, e rimangono quindi salvi, i diritti previsti nel Decreto Legislativo 6.9.2005 n. 206 e successive modifiche ed integrazioni (il "Codice del Consumo"), nel caso in cui il Cliente sia qualificabile come "consumatore".

## 3. CONDIZIONI DI OPERATIVITÀ DELLA GARANZIA

3.1 Ai fini dell'attivazione della Garanzia, il Cliente avrà l'onere di informare Fami S.r.l., nei limiti temporali di cui agli articoli 4 e 5 che seguono, della scoperta di difetti tramite una segnalazione (la "Segnalazione") avente i contenuti indicati nel seguente articolo 5.

3.2 Il Cliente, fatta la Segnalazione, dovrà interrompere immediatamente l'utilizzo del/i Prodotto/i difettoso/i.

3.3 A seguito della ricezione della Segnalazione, il Venditore potrà in essere quanto necessario per accertare l'esistenza, la natura e la consistenza dei difetti e per verificare la tempestività della Segnalazione ai sensi del seguente articolo 5. A tali scopi il Cliente sarà tenuto a rendere disponibile/i il Prodotto/i difettoso/i per la loro ispezione anche tramite l'invio di documentazione fotografica ovvero l'utilizzo di sistemi di videoconferenza. Il Prodotto verrà riparato dal Venditore presso la propria sede, la propria filiale, o presso un proprio rivenditore autorizzato. Il Venditore si riserva la facoltà di riparare il Prodotto presso il Cliente. Qualora sia necessario, il Cliente dovrà provvedere ad inviare a proprie spese il Prodotto difettoso presso uno dei predetti luoghi, così come indicato dal Venditore, fatte salve le norme del Codice del Consumo. Il Venditore trasmetterà al Cliente il nuovo Prodotto o il Prodotto riparato, sostenendo i costi di spedizione.

3.4 La riparazione di un Prodotto difettoso sarà effettuata in tempi congrui rispetto all'entità del difetto.

## 4. DURATA – PERIODO DI COPERTURA

4.1 La durata della Garanzia per i Prodotti è di 10 anni che decorre dalla data di consegna dei Prodotti, salvo che si tratti di Prodotti commercializzati, componenti elettronici, software e le parti di usura, per i quali viene prevista una garanzia di 12 mesi che decorre, sempre, dalla data di consegna degli stessi. Si precisa che per "data di consegna" si intende la data in cui i Prodotti hanno lasciato i magazzini di Fami S.r.l. per essere consegnati al Cliente, salva diversa previsione nel contratto di vendita.

4.2 Per i Prodotti riparati o sostituiti, la garanzia decorre nuovamente ed ha una durata di 12 mesi dalla riparazione oppure dalla sostituzione. Complessivamente, pertanto, la durata della Garanzia per i Prodotti riparati o sostituiti dal Venditore è di massimo 11 anni ovvero, per i Prodotti commercializzati, componenti elettronici, software e le parti di usura, di massimo 24 mesi dall'inizio della durata della Garanzia di cui al precedente articolo 4.1.

4.3 Alla scadenza del termine di cui al precedente articolo 4.1, il diritto di regresso previsto dall'art. 131 del Codice del Consumo, qualora esso sia applicabile, dovrà intendersi come prescritto ed inammissibile.

## 5. TEMPI E MODI DELLA SEGNALAZIONE

5.1 Durante il periodo di vigenza della Garanzia, eventuali reclami relativi allo stato dell'imballo, quantità, numero o alle caratteristiche esteriori dei Prodotti (vizi e difetti non occulti e visibili dall'esterno), dovranno essere annotati dal Cliente sulla bolla di consegna, firmando il D.D.T. indicando la dicitura "riserva specifica". Entro e non oltre 2 (due) giorni lavorativi dalla data di ricevimento dei Prodotti, il Cliente dovrà inviare al Venditore, tramite messaggio di posta elettronica al seguente indirizzo [assistance@famispas.it](mailto:assistance@famispas.it), copia della bolla di consegna e relativo rilievo fotografico, fornendo informazioni dettagliate sulle condizioni dei Prodotti e sulla natura dei difetti rilevati.

5.2 Eventuali reclami relativi a difetti non individuabili mediante un diligente controllo al momento del ricevimento (vizi occulti) dovranno essere notificati al Venditore, a pena di decadenza, entro e non oltre 7 (sette) giorni dalla data della scoperta del difetto, tramite messaggio di posta elettronica certificata al seguente indirizzo [pec@pec.famispas.it](mailto:pec@pec.famispas.it), specificando con precisione il codice prodotto, il lotto (se disponibile), la data di consegna e la natura del difetto.

## 6. ESCLUSIONI E LIMITAZIONE DELLA RESPONSABILITÀ

6.1 La garanzia non opera con riferimento a Prodotti i cui difetti sono dovuti a: a) operazioni di trasporto; b) mancato rispetto di accorgimenti rientranti nell'ordinaria prassi di manutenzione; negligenza e trascuratezza nell'uso; c) mancata osservanza delle istruzioni fornite dal Venditore per l'utilizzo e/o lo stoccaggio del Prodotto; d) mancato rispetto delle norme d'installazione e/o di ogni altra indicazione o istruzione riportata sulle note tecniche a corredo del Prodotto qualora l'installazione non sia stata curata direttamente dal Venditore; e) manomissioni, manutenzioni in genere, interventi operati al Cliente o da personale non autorizzato dal Venditore; f) uso anomalo e/o improprio del Prodotto, collocazione dello stesso in locali umidi, eccessivamente caldi o freddi, polverosi o aggressivi (presenza di cloro, lacche, vernici o altri agenti chimici e/o tossici) o comunque in locali non idonei alla corretta conservazione dei Prodotti nei limiti in cui tali circostanze non siano state documentate al Venditore prima dell'acquisto dei Prodotti ed il Venditore abbia garantito la tollerabilità dei Prodotti a tali ambienti; g) aggravio dei danni causato dall'utilizzo dei Prodotti da parte del Cliente una volta che si siano manifestati i difetti; h) utilizzo di parti di ricambio, componenti ed accessori non originali o non consigliati dal Venditore (non può essere richiesta la sostituzione o la riparazione di pezzi non originali) e danni provocati al Prodotto dall'uso degli stessi; i) anomalie o difettoso funzionamento dell'alimentazione elettrica; l) corrosioni, incrostazioni o rotture provocate da correnti vaganti, condense, aggressività o acidità dell'acqua, trattamenti disincrostanti effettuati impropriamente, depositi di fanghi o calcare; m) caso fortuito, cause di forza maggiore quali, a titolo esemplificativo e non esaustivo, gelo, surriscaldamento, incendio, furto, eventi naturali (come ad esempio, grandine, trombe d'aria, fulmini, inondazioni, terremoti), atti vandalici, incidenti e altri simili avvenimenti.

6.2 La Garanzia non opera se il prezzo di vendita dei Prodotti non è stato interamente saldato, con la precisazione che qualora il pagamento sia previsto in più scadenze, la Garanzia sarà da subito operativa e rimarrà tale fino a quando le scadenze di pagamento resteranno tempestivamente onorate.

6.3 Il Venditore non è responsabile per eventuali danni che possano, direttamente o indirettamente, derivare a persone, cose o animali, in conseguenza della mancata osservanza di tutte le prescrizioni indicate nel libretto di installazione, uso e manutenzione.

6.4 Il Venditore declina ogni responsabilità relativa a danni indiretti causati dalla difettosità di un Prodotto come, a titolo puramente indicativo ma non esaustivo, il fermo di produzione ovvero la mancata spedizione o cessione a terzi del Prodotto.

6.5 In ogni caso, la responsabilità del Venditore non potrà comunque eccedere il prezzo pagato dal Cliente per il singolo contratto di vendita dal cui contenuto è derivata la fattispecie inerente all'eventuale richiesta di danno e/o risarcimento.

6.6 I Prodotti dovranno essere utilizzati solo ed esclusivamente per gli scopi indicati e nel rispetto delle normative sulla sicurezza, conformemente alle previsioni del manuale di installazione, uso e manutenzione fornito dal Venditore; nel caso in cui il Cliente dovesse utilizzare o rivendere i Prodotti acquistati e/o Prodotti dal Venditore per scopi diversi, lo fa a proprio esclusivo rischio e pericolo, con ogni conseguente responsabilità. In tal caso, è esclusa la responsabilità contrattuale e/o extracontrattuale del Venditore per eventuali danni diretti ed indiretti subiti anche da terzi, nonché in caso di cattiva manutenzione, utilizzo improprio, non osservanza di norme di sicurezza ed altre ipotesi e il Cliente dovrà tenere il Venditore indenne da costi e/o responsabilità che potrebbero derivare a suo carico.

## 7. FORO COMPETENTE E LEGGE APPLICABILE

7.1 Per qualunque controversia derivante o connessa alle presenti Condizioni Generali di Garanzia quali, a titolo meramente esemplificativo e non esaustivo, controversie relative alla loro esistenza, validità, interpretazione, efficacia, esecuzione, è competente a decidere in via esclusiva il Tribunale di Vicenza, anche qualora il Contratto presenti elementi di internazionalità, fatte salve le norme inderogabili del Codice del Consumo.

7.2 Le presenti Condizioni Generali di Garanzia sono interamente soggetti alla legge italiana e interpretati secondo la stessa, anche qualora il Contratto presenti elementi di internazionalità, con espressa esclusione della Convenzione di Vienna del 1980.

# CONDIZIONI GENERALI DI VENDITA

## 1. DEFINIZIONI

1.1 Nel contesto delle presenti Condizioni, i termini di seguito indicati avranno il seguente significato:

- a) Venditore: Fami S.r.l.
- b) Acquirente: qualunque società, ente, entità giuridica che acquisti i Prodotti del Venditore;
- c) Prodotti: i beni fabbricati, assemblati e/o commercializzati dal Venditore;
- d) Ordine: ciascuna proposta di acquisto dei Prodotti inoltrata dall'Acquirente al Venditore;
- e) Conferma d'Ordine: l'accettazione scritta dell'Ordine da parte del Venditore;
- f) Contratto: la vendita conclusa tra il Venditore e l'Acquirente a seguito del ricevimento da parte dell'Acquirente della Conferma d'Ordine.
- g) Parti: il Venditore e l'Acquirente congiuntamente;
- h) Marchi: tutti i marchi di cui il Venditore è proprietario o licenziatario;
- i) Diritti di Proprietà Intellettuale: tutti i diritti di proprietà intellettuale e/o industriale di Fami S.r.l., ivi inclusi, senza limitazione alcuna, i diritti relativi a: brevetti per invenzioni, disegni o modelli, modelli di utilità, Marchi, know-how, specifiche tecniche, dati, software, indipendentemente dalla registrazione o meno di tali diritti, nonché qualsivoglia domanda o registrazione relativa a tali diritti ed ad ogni altro diritto o forma di protezione di natura similare o avente effetto equivalente.

## 2. DISPOSIZIONI GENERALI

- 2.1 Le presenti Condizioni Generali di Vendita (di seguito, le "Condizioni") formano parte integrante dei Contratti conclusi tra il Venditore e l'Acquirente per la fornitura dei Prodotti.
- 2.2 Le Condizioni si applicano tra Fami S.r.l. (di seguito, "Fami") e l'Acquirente senza la necessità che vi sia un espresso richiamo alle stesse o uno specifico accordo in tal senso. Qualsiasi condizione o termine differente trova applicazione soltanto se confermato per iscritto da parte del Venditore.
- 2.3 Il Venditore si riserva il diritto di modificare, integrare o eliminare qualsiasi previsione delle presenti Condizioni Generali di Vendita, in qualsiasi momento, dandone notizia anche tramite la pagina a ciò dedicata del sito aziendale, restando inteso che tali aggiunte, modifiche o cancellazioni si applicheranno a tutte le Vendite concluse a partire dal 15° giorno successivo alla comunicazione (tramite pubblicazione sul sito web oppure tramite invio di newsletter o qualsivoglia corrispondenza inviata per iscritto) all'Acquirente delle nuove Condizioni di Vendita.
- 2.4 Qualsiasi riferimento a termini commerciali (come EXW, DPA, DPU, DDP, etc.) è da intendersi come richiamo agli Incoterms® della Camera di Commercio Internazionale, nel testo in vigore alla data di stipulazione del Contratto.

## 3. AMBITO DI APPLICAZIONE

- 3.1 Le presenti Condizioni Generali di Vendita (di seguito, le "Condizioni") si applicano a tutti i Contratti (siano essi conclusi telefonicamente, a mezzo telefax, e-mail o sito internet), ove non espressamente derogate per iscritto dalle Parti e formano parte integrante e sostanziale di ogni Ordine, Conferma d'Ordine, anche se non espressamente citate.
- 3.2 L'Acquirente non può invocare né eccepire condizioni diverse dalle presenti Condizioni. Pertanto, non hanno alcuna validità le eventuali condizioni precisate per iscritto dall'Acquirente sull'Ordine, ovvero in qualsiasi altra fase della trattativa contrattuale nonché successivamente alla Conferma d'Ordine, così come le eventuali condizioni generali di acquisto dell'Acquirente stesso. Qualsiasi condizione scritta o verbale inviata da parte di collaboratori, dipendenti, agenti o rappresentanti del Venditore è priva di valore se non riprodotta nel testo della Conferma d'Ordine o se non confermata per iscritto dal Venditore. In tal senso, l'esecuzione, anche parziale, dell'Ordine da parte di Fami od ogni altro suo adempimento nei confronti dell'Acquirente non valgono e non possono essere interpretati come tacita o implicita accettazione di qualsivoglia condizione generale di contratto che non sia stata espressamente sottoscritta da Fami.
- 3.3 Le Condizioni sono valide esclusivamente per rapporti contrattuali tra Fami e operatori professionali, per cui non troverà alcuna applicazione il D.Lgs. 6 settembre 2005, n. 206 (Codice del Consumo) e successive modifiche.

## 4. OFFERTE E ORDINI

- 4.1 Le offerte del Venditore non sono da considerarsi vincolanti. Le indicazioni riportate su cataloghi, prospetti e listini non impegnano il Venditore, che si riserva la facoltà di apportare qualsiasi modifica ai Prodotti ed ai relativi prezzi; pertanto, il Venditore si considera vincolato esclusivamente da quanto riportato nella Conferma d'Ordine.
- 4.2 Ciascun Ordine inviato dall'Acquirente, sia direttamente a Fami sia per il tramite degli agenti o dei rappresentanti del Venditore, è da intendersi come una proposta irrevocabile d'acquisto, destinata a rimanere efficace per 30 (trenta) giorni, decorrenti dalla data della sua regolare ricezione da parte del Venditore, salvo esplicita deroga indicata di volta in volta.
- 4.3 L'invio dell'Ordine da parte dell'Acquirente implica l'integrale presa visione e la conoscenza da parte dello stesso di tutte le presenti Condizioni, le quali dovranno quindi intendersi integralmente accettate dall'Acquirente senza limitazioni e riserve.
- 4.4 Gli Ordini e/o le eventuali modifiche degli Ordini effettuati verbalmente o telefonicamente devono essere confermati per iscritto da parte dell'Acquirente. In caso contrario, il Venditore non si assume alcuna responsabilità con riguardo ad eventuali errori o possibili fraintendimenti.
- 4.5 Il Venditore si riserva espressamente di valutare ogni Ordine, non essendo vincolato alla loro accettazione.
- 4.6 Gli Ordini regolarmente accettati dal Venditore mediante Conferma d'Ordine non potranno essere annullati dal Compratore senza il consenso scritto del Venditore.

## 5. CONCLUSIONE DEL CONTRATTO

- 5.1 Il Contratto potrà dirsi concluso solo a seguito dell'invio di una Conferma d'Ordine da parte di Fami (via e-mail, telefax o altri mezzi telematici equipollenti), con riferimento ad ogni singolo Ordine. In ogni caso, l'emissione della fattura da parte del Venditore oppure l'esecuzione dell'Ordine da parte del Venditore sarà considerata quale conferma.
- 5.2 Qualora la Conferma d'Ordine contenga aggiunte, limitazioni o altre variazioni rispetto all'Ordine, l'assenso dell'Acquirente a tali variazioni si intenderà tacitamente prestato salvo contestazione scritta da far pervenire per iscritto al Venditore entro 2 giorni lavorativi dal ricevimento della stessa.
- 5.3 Modifiche e integrazioni richieste dall'Acquirente successivamente alla conclusione del Contratto non avranno valore ed efficacia se non accettate per iscritto da parte del Venditore, con l'eventuale precisazione dei nuovi termini di consegna, del prezzo e delle modalità di pagamento.
- 5.4 Tutti i Contratti si intendono sempre conclusi presso la sede legale di Fami S.r.l. in Italia, 36027 Rosà (Vi), Via Stazione Rossano n. 13

## 6. PREZZI

- 6.1 I prezzi dei Prodotti saranno quelli indicati nel listino prezzi del Venditore in vigore al momento della conclusione dell'Ordine o, qualora il Prodotto non sia inserito nel listino prezzi o il listino prezzi non sia disponibile, quelli indicati nella Conferma d'Ordine.
- 6.2 I prezzi dei Prodotti saranno quelli indicati nella Conferma d'Ordine e, salvo patto contrario, si intendono per merce resa franco fabbrica (EXW). Tali prezzi, fatta salva diversa indicazione nella Conferma d'Ordine, non comprendono i costi e le spese di imballaggi speciali, spedizione, assicurazione e trasporto dai locali del Venditore, ogni spesa, tassa o imposta inerente alla vendita dei Prodotti, inclusi i costi di tutte le formalità doganali (a titolo esemplificativo e non esaustivo: dazi, tasse ed altri oneri per l'esportazione dei Prodotti), che restano a carico dell'Acquirente.
- 6.3 Il Venditore si riserva il diritto di effettuare un adeguamento del prezzo nel caso di modifica (a) del Contratto, richiesto dall'Acquirente successivamente alla conclusione dello stesso ed accettato dal Venditore e (b) del tipo della fornitura, del materiale o dell'esecuzione dei Prodotti dovuti all'incompletezza ovvero alla non correttezza delle informazioni e/o della documentazione fornita dall'Acquirente.

## 7. TERMINI DI PAGAMENTO

- 7.1 Al momento della conclusione del contratto, il Venditore potrà richiedere all'Acquirente il versamento di una caparra confirmatoria pari al 30% del valore della fornitura. Le Parti in ogni caso possono pattuire il versamento di una caparra confirmatoria diversa previo accordo per iscritto nel Contratto.
- 7.2 In caso di mancato versamento della caparra confirmatoria, ove prevista, il Contratto si intende risolto ipso iure ed il Venditore potrà richiedere il pagamento delle somme sin a quel momento maturate, oltre al risarcimento di tutti i danni patrimoniali e non patrimoniali, nonché le spese, anche legali, eventualmente sostenute.
- 7.3 Ove nel Contratto non vengano precisate le condizioni di pagamento, esso dovrà essere effettuato a 30 gg. data fattura fine mese, mediante bonifico bancario. Il pagamento si considera effettuato quando la somma entra nella disponibilità del Venditore presso la sua Banca in Italia. Ove le Parti abbiano pattuito il pagamento anticipato senza ulteriori indicazioni, si presume che il pagamento anticipato si riferisca all'intero prezzo dei Prodotti inclusi nella fornitura. In caso di consegna ripartita in più soluzioni, l'acquirente dovrà, per ognuna di esse, versare l'importo corrispondente alla merce consegnata, salvo diverso accordo scritto previsto nel Contratto.
- 7.4 I pagamenti devono essere effettuati nella valuta concordata ed eventuali spese o commissioni bancarie dovute in relazione al pagamento saranno integralmente a carico dell'Acquirente.
- 7.5 In caso di mancato o ritardato pagamento, anche parziale, da parte dell'Acquirente, il Venditore, salvi tutti gli altri suoi diritti, avrà facoltà di sospendere le ulteriori consegne anche se queste fossero dovute in dipendenza di altri contratti e richiedere l'immediato ed integrale pagamento di tutto il materiale ordinato nonché di differire le proprie consegne per un termine pari al ritardo nei pagamenti, qualunque ne sia l'importo e ciò sino al saldo di tali pagamento e dei relativi interessi moratori.
- 7.6 Sui mancati e ritardati pagamenti il Venditore ha diritto al riconoscimento e al pagamento a suo favore degli interessi di mora ex D.Lgs. 231/2002, oltre alle spese, anche legali, che dovessero ritenersi necessarie per il recupero delle somme a qualsiasi titolo spettanti al Venditore.
- 7.7 Il mancato pagamento anche di una sola fattura comporterà per il Venditore il diritto di risolvere ogni Contratto in essere con l'Acquirente ai sensi dell'art. 1456 c.c. e di sospendere l'evasione o la consegna di ogni altra fornitura in corso di esecuzione, salvo in ogni caso il risarcimento integrale del danno conseguito dall'inadempimento o dal ritardo dell'Acquirente. Eventuali ritardi nell'evasione degli Ordini o nelle consegne causati da precedenti sospensioni della produzione per mancati pagamenti dell'Acquirente non costituiranno inadempimento del Venditore.
- 7.8 Qualsiasi reclamo o contestazione non darà diritto all'Acquirente di sospendere o ritardare i pagamenti.

## 8. TERMINI DI CONSEGNA

- 8.1 Il termine di consegna sarà quella indicata nella Conferma d'Ordine e, salvo patto contrario, si intende stabilita ex-works (EXW) presso lo stabilimento del Venditore. Se richiesto ed espressamente pattuito per iscritto nel Contratto, Fami si occuperà del trasporto dei Prodotti a rischio, costi e spese dell'Acquirente. Le eventuali spese di trasporto saranno a carico dell'Acquirente e ciò non inciderà in alcun modo sui rischi della spedizione che resteranno anche essi in capo all'Acquirente al più tardi con la consegna dei Prodotti al primo trasportatore.
- 8.2 La consegna dei Prodotti dovrà avvenire entro il termine indicato nel Contratto, computato in giorni lavorativi, precisato peraltro che i termini di consegna restano puramente indicativi e non sono termini essenziali e, in ogni caso, non includono i tempi di trasporto. Il Venditore, quindi, non risponderà del ritardo nella consegna per alcun motivo.
- 8.3 Qualora l'Acquirente richieda al Venditore una variazione del termine di consegna, dovrà effettuare la relativa richiesta per iscritto e procedere comunque al saldo della fornitura entro i termini indicati nell'articolo 7 delle presenti Condizioni. Restano esclusi i soli eventuali costi di custodia, consegna, montaggio, smontaggio e installazione, i quali dovranno essere saldati entro la nuova data di consegna pattuita.
- 8.4 Dal ricevimento dell'avviso di merce pronta l'Acquirente dovrà ritirare la merce nel termine massimo di 10 (dieci) giorni. In difetto, i Prodotti potranno essere stoccati all'aperto, con onere del Venditore da ogni responsabilità e decadenza, a beneficio di quest'ultima, di tutte le garanzie e con addebito all'Acquirente dei costi di movimentazione e magazzino, nonché di ogni altra eventuale spesa, sostenuti dal Venditore, che altresì si riserva la facoltà di far depositare la merce a spese dell'Acquirente.
- 8.5 Entro 10 (dieci) giorni dall'avviso di merce pronta il Venditore avrà la facoltà di emettere regolare fattura.

8.6 In caso di ritardo nel ritiro della merce, comunque approntata, per una qualsiasi ragione non dipendente dalla volontà del Venditore, la consegna si intenderà comunque come eseguita decorsi dieci giorni dalla comunicazione dell'avviso di merce pronta. In tal caso il Venditore avrà il diritto di procedere alla fatturazione e di reclamare l'adempimento delle condizioni di pagamento pattuite e potrà far effettuare l'imballaggio, il trasporto o lo stoccaggio della merce a spese dell'Acquirente, salvo il risarcimento dei danni eventualmente patiti, anche per l'immagazzinamento, la custodia ed il deposito della merce.

#### 9. GARANZIA E RECLAMI

9.1. La regolamentazione sulla Garanzia offerta dal Venditore è contenuta nel documento Condizioni Generali di Garanzia visionabile sul sito [www.famisp.com](http://www.famisp.com) e, per quanto riguarda esclusivamente i Prodotti a marchio Store Van, nel documento Condizioni Generali di Garanzia visionabile sul sito [www.storevan.com](http://www.storevan.com).

9.2 Al momento della presa in consegna dei Prodotti, l'Acquirente è tenuto ad esaminare i Prodotti alla presenza del trasportatore incaricato della consegna per verificare l'eventuale presenza di difetti visibili dall'esterno (a titolo esemplificativo e non esaustivo, le quantità e l'imballaggio dei Prodotti, la conformità dei Prodotti rispetto a quanto indicato nella Conferma d'Ordine).

9.3 Eventuali reclami relativi allo stato dell'imballo, quantità, numero o alle caratteristiche esteriori dei Prodotti (vizi e difetti non occulti e visibili dall'esterno), dovranno essere annotati dall'Acquirente sulla bolla di consegna, firmando il D.D.T. indicando la dicitura "riserva specifica". Entro e non oltre 2 (due) giorni lavorativi dalla data di ricevimento dei Prodotti, l'Acquirente dovrà inviare al Venditore, tramite messaggio di posta elettronica al seguente indirizzo [assistance@famisp.it](mailto:assistance@famisp.it), copia della bolla di consegna e relativo rilievo fotografico, fornendo informazioni dettagliate sulle condizioni dei Prodotti e sulla natura dei difetti rilevati.

9.4 Fatti salvi i termini di durata della Garanzia offerta dal Venditore, eventuali reclami relativi a difetti non individuabili mediante un diligente controllo al momento della presa in consegna dei Prodotti (vizi e difetti occulti) dovranno essere notificati al Venditore, a pena di decadenza, entro e non oltre 7 (sette) giorni dalla data della scoperta del difetto, tramite messaggio di posta elettronica certificata al seguente indirizzo [pec@pec.famisp.it](mailto:pec@pec.famisp.it), specificando il codice prodotto, il lotto (se disponibile), la data di consegna e la natura del difetto.

9.5 Qualsiasi Prodotto per il quale non sia stata sollevata alcuna contestazione conformemente alle procedure ed ai termini qui sopra indicati viene considerato approvato ed accettato dall'Acquirente.

9.6 In nessun caso agenti, clienti o intermediari del Venditore hanno il potere di rappresentare ed impegnare quest'ultima nei confronti dell'Acquirente o di altre terze parti. A tal fine ogni comunicazione relativa a vizi e difetti dei Prodotti sarà invalida ed inefficace qualora sia stata fatta ad agenti, clienti o intermediari del Venditore, ovvero in forme o modalità diverse da quelle sopraindicate.

#### 10. RISERVA DI PROPRIETÀ

10.1 I Prodotti rimangono di proprietà del Venditore fino alla data in cui l'Acquirente non abbia provveduto al pagamento dell'intero prezzo degli stessi e di tutte le somme dovute al Venditore.

10.2 Nel caso in cui nel paese in cui l'Acquirente ha la propria sede, per la validità della riserva di proprietà a favore del Venditore sia necessario l'espletamento di formalità amministrative o legali quali, senza alcuna limitazione, la registrazione dei Prodotti in pubblici registri, ovvero l'apposizione sugli stessi di appositi sigilli, l'Acquirente si impegna fin d'ora a collaborare con il Venditore e a porre in essere tutti gli atti necessari al fine di far ottenere a quest'ultimo un valido diritto, anche nei confronti di eventuali soggetti terzi, con riferimento alla riserva di proprietà.

#### 11. FORZA MAGGIORE

11.1 Sia l'Acquirente che Fami potranno sospendere l'esecuzione dei loro obblighi contrattuali quando tale esecuzione sia resa impossibile o irragionevolmente onerosa da un impedimento imprevedibile ed indipendente dalla loro volontà quale a titolo esemplificativo, non esaustivo, scioperi, epidemia e/o pandemia, boicottaggi, serrate, incendi, guerre, sommosse e rivoluzioni, requisizioni, embarghi, interruzioni di energia.

11.2 La Parte che desiderasse avvalersi della presente clausola dovrà comunicare immediatamente per iscritto, a mezzo posta elettronica certificata, all'altra il verificarsi e la cessazione delle circostanze di forza maggiore.

11.3 Qualora la sospensione dovuta a forza maggiore duri più di otto settimane, ciascuna Parte avrà il diritto di risolvere l'Ordine, previo un preavviso di 10 giorni, da comunicarsi all'altra per iscritto, mediante raccomandata con ricevuta di ritorno o mediante comunicazione a mezzo posta elettronica certificata.

11.4 In ogni caso, resta inteso che il Venditore avrà diritto di ottenere il pagamento dei Prodotti eventualmente già consegnati, oltre al rimborso di eventuali spese già sostenute.

#### 12. MUTAMENTO NELLE CONDIZIONI PATRIMONIALI DELL'ACQUIRENTE

12.1 Fami avrà diritto a sospendere l'adempimento delle obbligazioni derivanti dalla fornitura dei Prodotti nel caso in cui le condizioni patrimoniali dell'Acquirente divenissero tali da porre in serio pericolo il conseguimento della controprestazione, salvo che sia prestata idonea garanzia. Resta inteso che il Venditore avrà diritto di ottenere il pagamento dei Prodotti eventualmente già consegnati, oltre al rimborso di eventuali spese già sostenute.

#### 13. PROPRIETÀ INTELLETTUALI

13.1 I Diritti di Proprietà Intellettuale sono di totale ed esclusiva proprietà del Venditore e la loro comunicazione o utilizzo nell'ambito delle presenti Condizioni non crea, in relazione ad essi, alcun diritto o pretesa in capo all'Acquirente. Quest'ultimo si obbliga a non compiere alcun atto incompatibili con la titolarità dei Diritti di Proprietà Intellettuale.

13.2 L'Acquirente dichiara che: a) il Venditore è l'esclusivo titolare dei Marchi; b) si asterrà dall'utilizzare e da registrare marchi simili e/o confondibili con i Marchi; c) utilizzerà i Marchi esclusivamente in ottemperanza alle istruzioni del Venditore ed esclusivamente per i fini di cui alle presenti Condizioni.

#### 14. FORO COMPETENTE E LEGGE APPLICABILE

14.1 Per qualunque controversia derivante o connessa alle presenti Condizioni Generali di vendita e/o al singolo Contratto quali, a titolo meramente esemplificativo e non esaustivo, controversie relative alla loro esistenza, validità, interpretazione, efficacia, esecuzione, è competente a decidere in via esclusiva il Tribunale di Vicenza, anche qualora il Contratto presenti elementi di internazionalità.

14.2 In deroga a quanto sopra stabilito, il Venditore ha comunque la facoltà di portare la controversia davanti al giudice competente presso la sede dell'Acquirente.

14.3 Le presenti Condizioni Generali di vendita e/o ogni singolo Contratto sono interamente soggetti alla legge italiana e interpretati secondo la stessa, anche qualora il Contratto presenti elementi di internazionalità, con espressa esclusione della Convenzione di Vienna del 1980.

#### 15. PRIVACY

15.1. L'Acquirente dichiara di aver ricevuto tutte le informazioni previste ai sensi dell'art. 13 del Regolamento UE n. 2016/679 (GDPR) e presta il consenso al trattamento dei dati personali per le finalità di cui alle presenti condizioni generali di vendita e di essere stato informato che in relazione ai dati conferiti è possibile esercitare i diritti previsti dal D. Lgs. n. 196/2003 e del Regolamento UE n. 2016/679 (GDPR). Il Venditore dichiara che il titolare del trattamento dei dati raccolti è Fami S.r.l., con sede legale in Rosà (VI), Via Stazione Rossano n. 13, partita IVA e codice fiscale 03498610249

#### 16. OSSERVANZA DELLA L. 231/2001

16.1 L'Acquirente prende atto che Fami S.r.l. ha adottato ed attua un Modello di Organizzazione, Gestione e Controllo ex D.lgs. 231/01, con i relativi Codice Etico e Sistema Disciplinare i cui dettagli possono essere visionati sul sito aziendale [www.famisp.com](http://www.famisp.com). L'Acquirente aderisce ai principi al suddetto Modello di organizzazione, gestione e controllo nonché ai suoi allegati e si impegna a rispettarne i contenuti, i principi, e le procedure e, in generale, ad astenersi da qualsivoglia comportamento atto a configurare le ipotesi di reato indicate nel D.lgs 231/01 e sue successive modifiche ed integrazioni e riportate nel predetto Modello di organizzazione, gestione e controllo. L'Acquirente si impegna inoltre a rispettare e a far rispettare ad eventuali suoi collaboratori, tutti i principi contenuti nella suddetta documentazione ed i Protocolli comportamentali previsti dalla nostra organizzazione ai sensi del D. Lgs. 231/2001 ed allegati al presente contratto. La violazione delle regole previste dai sopracitati documenti rappresenterà grave inadempimento contrattuale.

#### 17. DISPOSIZIONI FINALI

17.1 Qualora una delle Parti ometta di intraprendere un'azione giudiziale o di esercitare un diritto in base alle presenti Condizioni, tale comportamento di acquiescenza non potrà essere interpretato come una definitiva rinuncia ad esercitare in futuro la stessa azione giudiziale o lo stesso diritto.

17.2 La vendita dei Prodotti da parte di Fami all'Acquirente non fa sorgere a favore di quest'ultimo un diritto di esclusiva territoriale né consente all'Acquirente di assumere la qualità di distributore o concessionario di Fami.

17.3 L'invalidità in tutto o in parte di singole disposizioni delle presenti Condizioni non inficia la validità delle restanti previsioni.

## BREVETTI

Alcuni componenti sono protetti da modello di design comunitario e/o brevetto di invenzione industriale.









[WWW.FAMISPA.COM](http://WWW.FAMISPA.COM)



VIA S. GIUSEPPE ROSSA, NO. 13  
36027 ROSA (VICENZA) ITALIA

TEL. +39 0424 58 54 55

FAX +39 0424 58 54 70

E-MAIL [INFO@FAMISPA.COM](mailto:INFO@FAMISPA.COM)

**UTENSILERIE**

**CORAG**